

E 870

JOURNAL ON

# COMMUNICATIONS

VOLUME XLV.

OCTOBER 1994

## NETWORKS

Editorial .....	Gy. Lajtha	1
Emerging information technologies		
in global networks .....	W. E. Falconer, S. Civanlar, N. F. Dinn and G. P. O'Reilly	3
Aspects of future network planning .....	E. Wollner	10
Continuing professional development for telecommunicaitons engineers .....	K. Ward	14
Network evolution in a competitive environment .....	J. Orlando, G. Thurston, S. Oxner and M. Cullum	21
Employing dynamic network control strategies in a competitive environment .....	V. Pizzica	24
Network planning system .....	K. Mase	28
Approaches to SDH network design .....	N. Seel and A. Wright	32
Network strategic planning support system for telecommunications		
infrastructure using geographical information .....	G. Kimura, H. Kato, M. Inoue and T. Ueda	37
<b>Individual Papers</b>		
Developing an audio coding demonstration package		
for educational purposes .....	B. Kalotay, Gy. Marosi and P. Tatai	41



# JOURNAL ON COMMUNICATIONS

A PUBLICATION OF THE SCIENTIFIC SOCIETY FOR TELECOMMUNICATIONS, HUNGARY

Editor in chief  
A. BARANYI

Senior editors  
GY. BATTISTIG  
T. KORMÁNY  
G. PRÓNAY  
A. SOMOGYI

Editors  
I. BARTOLITS  
I. KÁSA  
J. LADVÁNSZKY  
J. OROSZ  
M. ZÁKONYI  
N. WILK

Editorial board  
GY. TÓFALVI  
chairman

T. BERCELI  
B. FRAJKA  
I. FRIGYES  
G. GORDOS  
I. MOJZES  
L. PAP  
GY. SALLAI

Editorial office  
Budapest XIV. Ungvár u. 64-66.  
1525 Budapest, P.O.Box 15.  
Hungary, H-1525  
Phone: (361) 251-0888  
(361) 201-7471  
Fax: (361) 251-9878  
(361) 201-7471

Subscription rates  
Hungarian subscribers  
1 year, 12 issues 5300 HUF, single copies 650 HUF  
Hungarian individual subscribers  
1 year, 12 issues 860 HUF, single copies 110 HUF  
Foreign subscribers  
12 issues 150 USD, 6 English issues 90 USD, single copies 24 USD  
Transfer should be made to the Hungarian Foreign Trade Bank,  
Budapest, H-1821, A/C No. MKKB 203-21411

JOURNAL ON COMMUNICATIONS is published monthly, alternately in English and Hungarian by TYPOT<sub>E</sub>X Ltd. H-1015 Bp. Retek u. 33-35. Phone/Fax: (361) 115-1759. Publisher: Zsuzsa Votisky. Type-setting by TYPOT<sub>E</sub>X Ltd. Printed by Dabasi Jegyzetnyomda, Dabas, Hungary  
HUISSN 0866-5583

SPONSORED BY



**ERICSSON**   
Ericsson Technika

**SIEMENS**

Siemens Telefongyár Kft



FOUNDATION FOR THE  
"DEVELOPMENT  
OF CONSTRUCTION"

HUNGARIAN  
PRESS FOUNDATION





The last decade from 1984 to 1994. has resulted in a vast number of general changes in telecommunications. The changes are covering not only the field of technical development but political, economical, business, psychological, social problems too. There is a very close correlation between the different factors influencing the new tendencies in telecommunications. All those changes have had also an impact on the network planning. It is interesting to survey the five different factors modifying the process of network planning.

- The change of legal background: deregulation or reregulation, and the free competition.
- The great variety of technical possibilities, and the definitive role of software in the network management, and in the telecom equipment.
- The opinion, or the need of the users defines the probable success of new services.
- The competition and the new services force the service providers to fit the network to the real needs.
- The main task of network planning is now to fulfil the requirement of the service provider as soon as possible because the revenue of the operating companies has become of much higher priority. The time factor is one of the most important parameters. In order to create the revenue it is not enough to find the minimum investment cost but it is necessary to achieve the possible highest usage of the network as well.

Due to the above written legal, business and technical changes the network planning procedure must be based on a new concept. The presently applied network planning strategy was discussed at the Sixth International Network Planning Symposium, which was held 4th-9th September in Budapest. This event is giving a special actuality of the topic.

Looking back to the history of the Network Planning Symposia, we can see that the contents of the symposia have changed considerably, reflecting the circumstances and the importance of the different problems. In 1979, when we began to organise the first symposium, the main issue was the application of computers in the economic planning of networks. Part of the lectures treated the theoretical methods and their realization by programmes. The introduction of new equipment such as the SPC exchanges, the role of the digital transmission, of the fibre optic telecommunication and of the radio communication figured among the subjects. It was clear from this fact that the conference tried to find solutions for the issues of the rapid quantitative growth. The proper organization of investment, the selection of appropriate network structures and the selection of the related equipment received priority. The problems of the equipment selection was characterized by the acronym DOMSAT, which describes the objectives of Digital, Optical, Microwave, Satellite, Automation. Based on the results of the Conference in Paris in 1980, the problems of the operational costs were put forward in 1983 in Brighton. The economic attitude had a decisive impact on the following symposia, too. The price

of electronic products dropped. The distance to be covered had no significant impact on the cost of connections. When we held the Third Network Planning Symposium in Florida, a new planning aspect came to light. How can the costs of the ground, the building and infrastructure be reduced by applying eventually longer connections? At that time the minimization of investment costs received a new meaning. The quality of operation and service became the main aspect. It was raised then that in many fields of the economy, the administration, the commerce and the corporate-technological telecommunications and informatics became an organic part of the technological processes of companies. Therefore the break-down of telecommunications could cause incorrigible troubles and jams. As a consequence of the growing importance of telematics the restoration of transmission routes and the completion of the network by redundant elements became a problem to be solved. In Florida and Mallorca, the main themes were the minimization of the life cycle cost and the continuous operation as well as the optimization of the revenue.

In the meantime telephony that is voice transmission loses its monopolistic position. The range of telecommunications services has been enlarged: text transmission, image transmission, connection between computers and several operational task of control and alarming enlarges the spectrum. The subject of networks appropriate for the transmission and connection of different new information pieces was brought to focus. In 1992 the Tokyo conference can be characterized by the broadband transmission and switching, supporting the new types of information transfer without band-width limitations.

In 1994 at the Budapest symposium the papers reflected a new general change. The Symposium promoted in a higher class. Using and repeating the subjects of the earlier conferences now we discussed a higher level of network planning, the strategic level. The above mentioned five reasons directed the interest to the business. It means that the deregulation, competition and the market oriented development must change the thinking of the network designers. The social aspects of telecommunications, and therefore the question of application requires more and more attention besides technical issues. The new strategic concept has also an influence on the technical development. The acronym word characterizing our present tasks is VIP, that is Video, Intelligence and Personal. This acronym shows that from the earlier technology oriented targets telecommunications turned to a service orientation. The appearance of intelligent network provides greater choice of services to users and ensures more comfort for them. Not only the comfort but also the mobility is a need. For satisfying these requirements, the issues of mobile and personal networks, network management and the quality of services received a primary role.

Network planning became a sophisticated task. The economic, legal, financial, social and technical environments have impact on several steps of the process. Therefore it is not possible to solve the problem with simple op-



timizing algorithms. Influencing factors must be weighted and a strategy is necessary based on the risk analysis, and "game theory". These general statements can be supplemented by some practical rules. The following directives can be used in the course of network planning and implementation:

1. The greatest impact on network planning has a legal origin. The free market is taking over the place of the state owned monopoly. The competitive environment emphasizes the speed of the installation of the network. It makes necessary to evolve methods promoting the fast implementation. So the operator can enter and win new promising markets realizing new revenue sources. But the uncertainty of the real needs, and the hardly forecastable future tendencies are working against the quick service provisioning. Therefore risk analysis became a part of network planning. Either the planning must be versatile or the service provider should take over the risk and he gives the specification for the network planners.

2. The large scale of possibilities offered by telecommunications can be used only if it is working safely without any disturbances. The customer can trust in the service provider only if the services are really reliable. Therefore the reliability calculations became an important tool in the hands of the network planner. So the use of reliable network structures and self-healing solutions have got priority. Further-on the realization of the result of the reliability calculation enhances the importance of the introduction of new maintenance methods and the network management.

3. The new technology can be used to achieve the tasks drafted in 1 and 2. It is possible to choose from the great variety of the offered new technical solutions. The choice is not simple but on the symposia some promising technologies were emphasized. The ring network, the cross connect technology, and the SDH transmission method in the present situation is offering quick rerouting, dynamic and flexible change of configuration. At this point the introduction of ATM technology will have dominant role in the future. It improves the flexibility of the network, which is an important factor in the competitive environment, and supports the cooperation of telecom and entertainment networks.

4. To plan a user-friendly network was the aim of the symposia. It seems to be in conflict with the business ori-

entation of the service-provider. The user can accept the competition only if it is combined with cooperation. The interoperability and interconnection of networks belonging to different operator is a must. To serve the customer with services fitted to their personal and changing wishes, and needs can be done by softwares. The intelligence of the stored programm controlled exchanges can extended to the whole network. These intelligent networks (IN) can fulfil the wishes of the customers and enlarge the income of the service providers. The mobile service is a not negligible part of the telecommunication. The mobility is based also on IN features.

5. The specially tailored, customer oriented services, the planning and operation are developing too. To match the network to the above listed targets some computer aided process must be used. The operation support systems are based on sophisticated information methods, which include not only data of telecommunication origin but also the geographical information systems (GIS) and some business data.

Beside the five general points characterizing the planning and maintenance of telecom network, there was some interesting minor points. One of these is a surprising statement supporting the development of services. It had a human engineering content: not only the low price can enhance the usage of a service but the simplicity of the user interface has a decisive impact as well.

In this issue we don't want to repeat any paper from the Proceedings of the symposium discussing the planning of user friendly networks but we asked some of the past (E. Falconer, K. Ward) and present (K. Mase) members of the International Scientific Committee to write a special paper for the Journal on Communications. We asked some speakers, who discussed a really perspective topic to give us a more detailed version of their talk (G. Kimura, N. Seel, V. Pizzica, J. Orlando). Last but not least I received a paper which is independent from the Networks which, however, fits excellently to this issue (E. Wollner).

I hope that the friendly international cooperation will help in building a new reliable, broadband network connecting every country of the world. It will support the building of the information society, which is not a target for itself, but it is also paving the way leading to a higher quality of life.

GY. LAJTHA

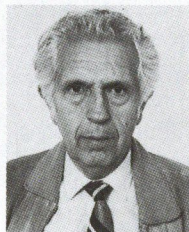

**György Lajtha** received the Master of Engineering degree from the Technical University of Budapest in 1952. After the University he is the engineer of the Post Office Research Institute. Scientific Vice Director of the PKI from 1974 to 1986. From 1986 to 1990 adviser of the Hungarian Telecommunications Co. Research fields: data transmission, maintenance, reliability, optical network planning, optical fibre, PCM. Ph.D. in 1963. Doctor of Technical Science in 1977. He received the highest prize in Hungary the Széchenyi Award in 1992. He is retired in 1990. Presently he is the editor-in-chief of the Hungarian Telecommunication Journal (Magyar Távközlés).



# EMERGING INFORMATION TECHNOLOGIES IN GLOBAL NETWORKS

W. E. FALCONER

AT&T INTERNATIONAL OPERATIONS DIVISION  
412 MT. KEMBLE, AVENUE MORRISTOWN, NJ 07960

N. F. DINN

AT&T BELL LABORATORIES

S. CIVANLAR,

AT&T BELL LABORATORIES

G. P. O'REILLY

AT&T BELL LABORATORIES

A major challenge for global carriers is the rapid translation of emerging technologies into advanced global networking capabilities, to offer a portfolio of global information services at affordable prices. The international carriers are responding to this challenge by aggressively addressing three key aspects of technology. These aspects are transport, interoperability, and networking. Since global networks are not only technologically complex, but involve many regulatory and economic constraints, it is important to understand the framework in which the challenge is addressed. Each country has a history of different standards; they typically are at different stages in their telecommunications infrastructure development, and indeed, the customers operating in these environments have different expectations. The international market is also very dynamic, shifting and expanding rapidly as networks are privatized, new competitors emerge, and strategic alliances are formed. It is important to understand how these various forces impact the emerging information technologies. This paper attempts to put the new technologies and forces in perspective, and demonstrates how, in spite of all the complexities, the international network infrastructure is rapidly advancing to support the emerging information needs.

## 1. INTRODUCTION

Multi-national corporations today use computers and computer networking to collect and disseminate information associated with essentially all aspects of their business activities. The airline industry, financial institutions, real estate, construction, small businesses, heavy industry and health-care are just a few examples of heavy information users. In fact, virtually all US businesses rely on processing of information. Personal computers, workstations, terminal devices, databases, and numerous application specific software tools are now part of many companies' day to day operations, supporting various data applications. High-bandwidth information-based applications such as multi-media and virtual networking are emerging, although they are still in their infancy. For example, the whole area of multi-media has grown significantly in the past few years to encompass many applications, ranging from simple graphics and images to full-motion video and workstation-based video conferencing. In the early 1980s, all these applications were considered truly visionary, but now interactive access to public video servers supporting broad-band applications such as movies-on-demand and electronic-games are being piloted throughout the world. These advanced information applications have been placing increased demands on the telecommunications infrastructure as their use becomes widespread.

Since effective access to information is now key to productivity in a competitive market place, interconnection of various geographically dispersed information sources becomes very important. This interconnectivity is provided by the Local Area Networks (LANs) and Wide Area Networks (WANs). There are three basic issues regarding interconnectivity. The first one deals with the fundamental engineering issue of the transport medium over which the communications will take place. Interoperability, the second of these issues, lies on top of the transport, and deals with transmission of information with efficient, reliable, secure, high-performance protocols, connecting many different technologies. In addition, interoperability addresses the operations and management aspects of the network. The third issue is networking, which deals with switching of information from one node to another in a network. The challenge is transparent switching of various types of information with different throughput, bandwidth, delay and performance requirements.

In this paper, we identify these three dimensions, namely transport, interoperability and networking of the international network infrastructure as being crucial to support the information revolution underway in national networks [1]. Although, each individual dimension is very broad and spans many topics, we will attempt to focus on selected areas per dimension. In terms of the transport network infrastructure, the essential elements are the worldwide fiber optic cable connectivity, and availability of SDH transmission to support high-bandwidth applications at the physical layer. In terms of interoperability, the Open System Interconnect (OSI) protocols offer open interfaces to allow a wide spectrum of technologies to be interconnected. We will highlight the progress in CCITT Telecommunications Management Network (TMN) standards for management of complex international networks. In terms of networking, we will discuss the ATM technology, and a recent international trial in which AT&T, KDD and TELSTRA have been participating.

## 2. INFORMATION TECHNOLOGY TRENDS

The growing use of computers and other information processing systems signify that telecommunications trends can no longer be treated in isolation from trends in information technologies. Thus, the characterization of information trends is important for understanding the emerging telecommunications infrastructure needs and directions.



Information technology is characterized by the advances in computing, telecommunications and display technologies. There have been several interesting technological developments during the last decade which are now shaping the direction of information technology:

- *Convergence of Computing and Communications:* Digital technology enabled the convergence of computing and telecommunications which were traditionally distinct industries. Many components of the telecommunications network are now computers; digital switches, operations systems and all digital telecommunication equipment rely heavily on computing. At the same time, the telecommunications standards are evolving to accommodate data as well as traditional voice and fax traffic. The computer manufacturers produce inexpensive plug-in boards for personal computers (PC) for networking to exchange data, image, audio and video.
- *Convergence of TV display and computer screen:* The major obstacle for merging the two display technologies has been the different resolution standards. There are two schools of research for the merger of TV and computer screens; one is improving the TV display resolution with technologies such as High Definition-TV (HDTV) so that computer generated information can be displayed on a TV screen. The second approach is to include the TV display on a computer screen using the window system. Additionally, the advancements in flat-panel TV display technology will ease the realization of large-scale displays for home or work.
- *High-Bandwidth Access:* Efforts to provide high-bandwidth access are critical for widespread use of information technologies at home and work. Among possible high-bandwidth access alternatives being considered are fiber-optic access, existing unshielded twisted-pair access with encoding technologies such as Carrierless AM/PM (CAP), Asymmetric Digital Subscriber Loop (ADSL), High Bit Rate Digital Subscriber Loop (HDSL), and cable-TV access.
- *Advances in Video Coding:* International standards for video compression methods such as MPEG-1 and 2, and JPEG have matured, and off-the-shelf inexpensive video coders are now commercially available. Utilizing image compression technologies' continuous advance, it is now becoming inexpensive to transmit TV-quality moving images on fiber optic telecommunications networks.
- *Graphical User Interface:* A decade ago it was almost impossible to envision a computer-illiterate user accessing and using computer applications; the command-based and ASCII-based user interfaces required substantial computer training. With the advances in graphical user interface technology, the users can now access very sophisticated applications without any computer training at all. The state-of-the-art graphics environment offers a workspace with simple pop-up menus, on-line help buttons, windows, hyper-text capabilities, and mouse based operations. Selections are being made through simple click-operations with the mouse, eliminating the need to resort to a key-board. The software complexity is completely hidden behind the user interface, enabling the user to focus on the application. These features are accelerating the penetration of information technology

into typical house-holds and virtually all business segments.

One of the most exciting information applications of recent years is the World Wide Web (WWW): The World Wide Web (WWW) is a network of thousands of computers (servers) glued together with a phenomenally popular client software called MOSAIC, and an internet based network connecting the servers and the clients. WWW enables thousands of information servers throughout the world to be knit together, simply allowing sharing of various forms of publicly available information. As part of WWW, AT&T Web extends geographically to most of the world, covers multiple business units in AT&T, and offers various forms of information to AT&T users and the world. AT&T Web is a completely distributed application, not tied into any central authority or server. AT&T organizations are contributing information to the Web in audio, video, text, graphics and image forms. The MOSAIC software sits on each user's (client's) computer connected to the internet, and allows the user to access information made available on WWW servers, through a simple menu-driven hyper-text based user interface. With simple key word searches, MOSAIC guides the user to the information requested. As example applications, AT&T Bell Laboratories researchers developed a low-bit rate video coding software called NEMESIS [2] which enables the user to extract talks and video presentations to run on their workstations. As another example, AT&T researchers have been conducting a trial internally for electronic subscription to the New York Times and Wall Street Journal through MOSAIC. The newspaper will be stored as text with images, and through MOSAIC, the user will be able to access it.

With this and many other sophisticated applications, vast amounts of information will flow over telecommunications networks, improving: personal lifestyles, business, industry, education, health care, and essentially all aspects of living. In these exciting times, the network providers are focused on the network infrastructure needed to pave the information highway. One of the key technologies is photonics, and a critical enabling application has been fiber-optic submarine cable systems.

### 3. FIBER-OPTIC CABLES

The first trans-oceanic telephone cable system, TAT-1 was installed in 1956, with 118 repeaters. There were two unidirectional cables with 36 one-way voice circuits on each cable. Six other coaxial Trans-Atlantic cables followed, with TAT-7 marking the end of trans-oceanic analog coaxial cable systems [3]. All subsequent systems have been based on fiber-optic technology.

With the earlier development of terrestrial fiber optic systems, a series of experimental optical submarine systems were deployed by the US, UK, France and Japan between 1980 and 1985. A major breakthrough in fiber-optic systems was the trans-atlantic TAT-8 link between England, France and the US in 1988, offering 7,560 64 Kbps channels capable of carrying up to 40,000 voice circuits. Since then, fiber-optic submarine cable systems have enjoyed tremendous growth, which is expected to continue well into the next century. A summary of the Trans-Atlantic cables is provided in Table 1.



Table 1. Existing and Planned Trans-Atlantic Fiber Optic Cable Systems

Cable	Service Date	Transmission Rate	Cable Length (km)	Appr. Cost	Landing Countries
TAT-8	1988	2x280 Mbps (service)	6,740	\$360 M	US,UK, France
PTAT	1990	2x420 Mbps (service)	6,869	\$300 M	US,UK, Bermuda, Ireland
TAT-9	1992	2x560 Mbps (service)	9,310	\$448 M	US,UK, Canada, France, Spain
TAT-10	1992	2x560 Mbps (service) 1x560 Mbps (restor.)	7,414	\$300 M	US,Germany, Netherlands
TAT-11	1993	2x560 Mbps (service) 1x560 Mbps (restor.)	7,162	\$280 M	US,UK, France
COL-2	1994	3x560 Mbps (service) trans-atlantic only	12,102	\$345 M	US, Mexico, Portugal, Spain, Italy
TAT-12/13	1995 (TAT-12) 1996 (TAT-13)	total of 2x4.8 Gbps (service) 2x4.8 Gbps (restor.)	6,100 (TAT-12) 6,300 (TAT-13)	\$750 M (total)	US,UK, France

While there has been considerable activity in the Trans-Atlantic region, there has also been an increasing number of projects taking place in the Pacific Rim where traffic densities are growing rapidly. In 1989, Trans-Pacific-3 (TPC-3) and Hawaii-4 (HAW-4) came into operation linking Japan, Guam, the continental US and Hawaii at a rate of 280 Mbps. The TPC-4 cable system was completed in 1992, at 560 Mbps rate, with nearly 10,000 km of fiber optic cable linking the US, Japan and Canada. The next Trans-Pacific cables are TPC-5 and 6 which will operate at 4.8 Gbps with a ring configuration totaling nearly 23,000 km connecting the US, Guam, Hawaii and Japan. The ring configuration will include one fiber pair for built-in restoration. Although Trans-Atlantic and Trans-Pacific cables are among the most significant cable systems due to their length and capacity, there are many other fiber optic submarine cable systems which have been installed at different parts of the world (see Fig. 1).

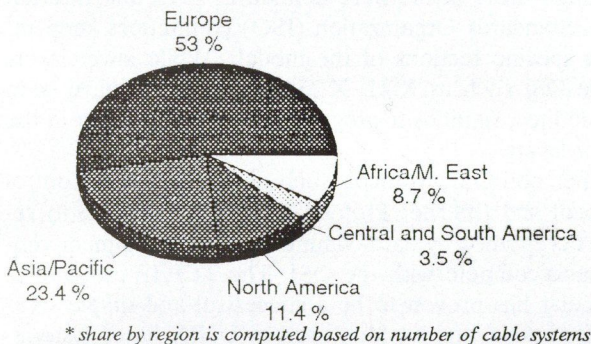

Fig. 1. World Submarine Links (Share by Region\*)

Since the first repeatered submarine telephony cable system in 1956, 365 systems have been installed world-wide. Fiber optic submarine cable systems, which only began in 1988, now account for 77 (21 %) of all systems. With the continuous increase of fiber optic cable capacity, the cost per circuit is declining drastically [2], increasing the economic attractiveness of fiber-optic submarine cables compared to other alternatives. Thus, today more than 52 % of the world's international traffic is carried via submarine cables (see Fig. 2).

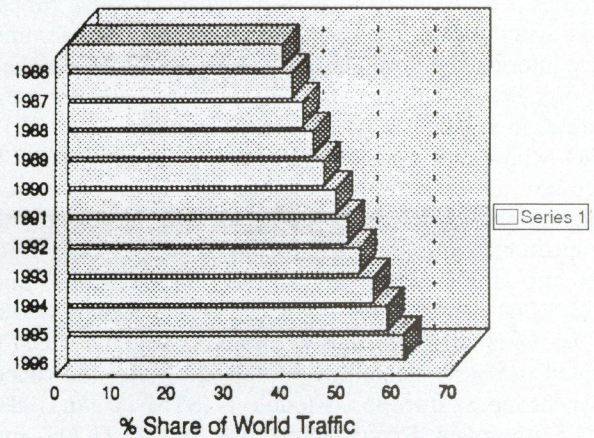

Fig. 2. International Traffic on Fiber-Optic Submarine Cables (4)

From a technology perspective, compared to copper based alternatives, fiber optic transmission systems have better immunity to interference, exhibit lower signal loss, and can carry significantly more traffic accurately at greater distances. Photonic systems also have lower maintenance and servicing costs. While satellite capacity has continued to develop apace, it has the inherent disadvantages of delay, interference, and atmospheric degradations which must be accounted for.

A major thrust by designers of optical submarine systems has been to eliminate the regenerative repeaters of the cable network. A considerable amount of work has been done using laser pumped sections of erbium-doped fiber which act as optical amplifiers without need of optoelectronic conversion. AT&T's optical amplifier technology will be put into — commercial service with the planned submarine cable systems such as TPC-5/6 and TAT-12/13 along with others. One can now envision world-wide repeaterless fiber optic systems spanning the oceans before the end of the decade.

#### 4. SDH TECHNOLOGY

While high-capacity and accurate global transmission were made possible globally by fiber-optic cable technology, it also became clear that major improvements in interconnection and network management could be achieved by making these systems synchronous. Thus, during the 1985-1992 CCITT study period, the Synchronous Digital Hierarchy (SDH) standards were pursued vigorously, and its close relative, Synchronous Optical Network (SONET), was being fostered by Bellcore. In 1984, Bellcore submitted the SONET proposal to the American National Standards Institute (ANSI) T1X1 subworking group describing



communications networks operating over fiber-optic facilities. The SONET network was intended to exploit fiber's large bandwidth while allowing a smooth transition from the existing wire-based networks. It was aimed at providing cross-connection at the optical level, eliminating many DS3 electrical interfaces to fiber terminals, and DS1 interfaces to DS3 multiplexers, and copper pairs.

The SDH-SONET disparity is an excellent example of the complications in the international arena as one attempts to interconnect various systems from different countries. SONET uses a base signal of 51.84 Mbps, called Synchronous Transport Signal level-1 (STS-1), and a byte interleaving multiplexing technique to create higher rate signals. The signal level of STS-1 was chosen because, in the US, most networks are managed in DS1s (1.544 Mbps) and DS3s (44.736 Mbps). In 1986, CCITT expressed an interest in defining an optical interface similar to the work conducted in the US. However, the European networks are not managed at DS1 and DS3 rates but at E1 (2.048 Mbps), E3 (34.368 Mbps) and E4 (139.264 Mbps) rates for which STS-1 signals would not be suitable. To satisfy these constraints, CCITT adopted the basic signal rate of 155.520 Mbps and called it Synchronous Transport Module-1 (STM-1). In 1988, CCITT approved Recommendations G.707, G.708 and G.709 which specify bit rates, multiplexing structure, and network node interface. According to these standards, SDH provides a common hierarchy for the three different international hierarchies:

- *Northern America:* 64 Kbps, 1.544 Mbps, 3.152 Mbps, 6.312 Mbps, 44.736 Mbps, and 274.176 Mbps.
- *Europe:* 64 Kbps, 2.048 Mbps, 8.448 Mbps, 34.368 Mbps, 139.264 Mbps, and 565.148 Mbps.
- *Japan:* 64 Kbps, 3.152 Mbps, 6.312 Mbps, 32.064 Mbps, 97.728 Mbps and 397.2 Mbps.

Table 2. Relationships among STM, OC and DS0

Line Rate (Mbps)	STM Level	No. of User DS0s (64 Kbps)*	OC Level	No. of User DS0s (64 Kbps)**
51.84			OC-1	672
155.52	STM-1	1,890	OC-3	2,016
466.56			OC-9	6,048
622.08	STM-4	7,560	OC-12	8,064
933.12			OC-18	12,096
1,244.16			OC-24	16,128
1,866.24			OC-36	24,192
2,488.32	STM-16	30,240	OC-48	32,256

\* assumes 30 DS0s per E1

\*\* assumes 24 DS0s per DS1 and SONET/SDH multiplexing

The relationship between the STM, Optical Carrier (OC), and DSs is shown in Table 2. The OC-N is applicable to direct optical transmission of STS-N, the electrical signal of SONET.

SONET/SDH is an evolutionary step in developing the optical all-digital network. The need for a standard emerged from expanding fiber-optic networks and the need for communicating among various vendor's equipment nationally and internationally. It offers a new standardized method of assembling various common digital signals

into a high-speed optical signal with easy access to the tributary signals. It allows simplified multiplexing and demultiplexing, add-drop and cross-connect operations. Also, through a large number of overhead bytes, it allows powerful network management, operations and reconfiguration.

As part of the international high-speed transport network plans, various new cable systems are planned to support SDH formats. Table 3 shows, a list of fiber-optic submarine cables which are currently planned to be SDH.

Table 3. Planned SDH Based Fiber-Optic Cable Systems

Cable	Cable End Points
CANTAT-3	US, Canada, Iceland, Denmark, Germany, UK
RIOJA	Spain, Belgium, UK, Netherlands
TPC-5/6	US, Japan, Guam, Hawaii
TAT-12/13	US, UK, France

## 5. OPEN SYSTEM INTERCONNECTION (OSI) AND TELECOMMUNICATIONS MANAGEMENT NETWORK (TMN)

Standards organizations have been developing reference models to enable standardized information exchange procedures among various international telecommunications users. Communication systems which employ standardized communications procedures and protocols are referred to as "open systems", and such interconnection is referred to as "open system interconnection (OSI)". The OSI structure calls for compatibility among systems, and cooperation of different manufacturers and designers. With OSI, global digital networks can become a reality.

The reference model of OSI defines a seven-layer protocol for communications between two communications entities. These seven layers are physical, data link, network, transport, session, presentation and application layers as defined in CCITT X.200 [6]. The highest layer is the application layer which consists of the application entities (say two computer programs) that cooperate in the OSI environment. Layers 1-6, provide a step-by-step enhancement of communications services. These seven layers cover all aspects of information flow from applications-related services to the communications medium at the physical layer. Although these layers were defined in 1979, the International Standards Organization (ISO) committees keep refining specific sections of the model. While lower layers of the OSI such as X.21, X.25, LAPB, Q.931 have been well defined, significant progress is now being made in the higher layers.

Other non-OSI protocols such as Transmission Control Protocol and Internet Protocol (TCP/IP) continue to receive acceptance by data-communications equipment vendors and compete with the OSI. The TCP/IP protocol in particular has proven to be a successful and simple solution for LANs, and is widely used by UNIX-based systems.

The OSI-based network management protocols continue to capture attention as the best solution for multivendor network management. In our current environ-



ment, a given vendor's products are generally being managed only by that vendor's products. With the OSI-based network management, this one-to-one relationship will be split, allowing any OSI-based network management system to manage any OSI conforming device.

One of the recent key developments in OSI-based network management standards has been accomplished in parallel with the CCITT Study Group (SG) XV's SDH modeling efforts. This effort resulted in development of Telecommunications Management Network (TMN) standards. TMN defines an organized architecture to achieve interconnection between various Operating Systems (OS) and/or network elements (NE) for the exchange of management information using standardized protocols and interfaces. The CCITT SG IV developed a generic reference model for TMN in the form of an "information model" which defines the structure of the management information conveyed externally between OSs and NEs. The information model deals with "managed objects" which are abstractions of communications entities for the purpose of management.

Historically, the TMN information model is based on the "object-oriented" software paradigm which has advanced significantly during the last 5 years with the developments in software programming methods such as AT&T Bell Laboratories' C++. The primitive element of "object-oriented" software is a so called "object" which is an encapsulation of data and functions. Object oriented software, with its modularity and re-usability, has advantages over conventional software.

In the TMN approach, the management processes are categorized as either managers or agents. A manager is that part of a distributed application which has the responsibility for one or more management activities, while an agent, at the request of a manager, manages the associated managed objects. The agent is responsible for updating all the managed object properties to reflect the actual state of the underlying managed resource. As shown in Fig. 3, an agent performs management functions on managed objects upon receipt of management operations from the manager. Agents may also forward to managers any notifications generated by managed objects.

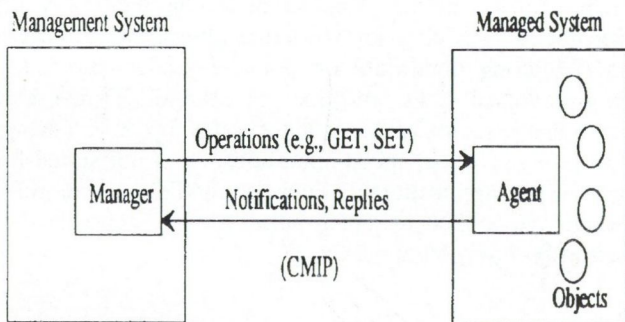

Fig. 3. Manager/Agent Relationship

The set of commands and the method of exchanging TMN information between two open systems are defined by CCITT, through Common Management Information Service Elements (CMISE) in CCITT recommendation X.710. The associated protocol, Common Management Information Protocol (CMIP), along with the syntax is

also specified by standards in the accompanying CCITT recommendation X.711.

International management networks form a complex aggregation of various Operating Systems (OSs) and Network elements (NEs), in which each OS manages one or more NEs in a separate telecommunications network. TMN has made the task of development of an open interface for such management networks a much more straightforward task. One such managed network is the network of Global Networking Project (GNP) [7], an initiative among six carriers: AT&T, BT, DBPT, FT, KDD and Telstra. GNP is intended to provide a reconfigurable E1 transport network by means of using a two-tier network management network. As illustrated in Fig. 4, at the top layer, the Global Network Management System (GNMS) communicates with six Local Network Management Systems (LNMS), each located in a carrier's network. GNP uses the TMN X-interface where X defines the TMN interface between two OSs in different telecommunications domains. The openness of the TMN interface allows other carrier's management networks to tie into GNP readily. The GNP management network enables the automated reconfiguration of the bilaterally-owned E1 capacity between GNP Party pairs, exploiting time of day capacity utilization variations. The coordination of network reconfiguration actions between the cross-connects will be accomplished through the management network consisting of GNMS and LNMSs. Various telecommunications equipment manufacturers are now developing products with interfaces using TMN standards to achieve open systems interconnection.

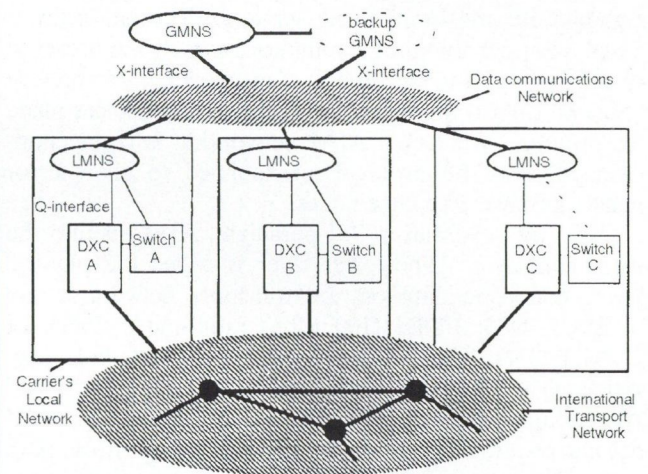

Fig. 4. GNP Network Management Architecture

## 6. ATM STANDARDS AND TRIALS

In recent years, the most important factor driving the evolution of business information networking has been the increasing demand for high-performance and high-speed data networking. With large multinational corporations, data applications have become distributed, exploiting shared access to common computing sources. Many large businesses rely primarily on electronic databases and file transfers. Local Area Networks (LANs) are currently penetrating every business sector with an installed base in North America doubling every two years. Many software



vendors have been advocating sophisticated multi-media desk-top products which are now available on Personal Computers. Coupled with these advances, low bit rate video coding methods and standards have matured, and many codecs (MPEG, JPEG and Px64) are made available for commercial use. While voice traffic has been traditionally an important component of the information network, the importance of broad-band applications including data, video and multi-media has been steadily growing.

From the transmission technology perspective, fiber optic cables and SDH/SONET standards provide the transport infrastructure for high-speed applications globally. To complete the network infrastructure, a flexible high capacity switching vehicle is also needed. This has evolved from frame-relay to cell-relay and became standardized as ATM. The ATM standards have matured, and many equipment manufacturers have ATM switches and cross-connects commercially available for networking.

ATM is an advanced multiplexing and switching technique which, after being studied extensively by the R&D community in recent years, is now being introduced in telecommunications networks as the solution for implementing broadband ISDN. ATM, with its small fixed size cells of 53 bytes consisting of a 5 byte header and 48 byte payload, is an efficient form of packet switching. It provides a simplified protocol compared to other packet protocols such as X.25 and frame-relay, and is suited to carry fixed or variable rate traffic over a common broad-band interface.

One of the major characteristics of ATM is its capability to support a wide range of services, including real-time, high-bit rate and multi-media services. This capability is based on a technological assumption, namely the presence of a high speed and high quality transmission infrastructure based on optical fibers, and on architectural choices made for protocol structure. ATM networking is connection-oriented, and the protocol is simplified to allow error handling only at the edge nodes.

Using the seven-layer OSI paradigm, ATM fits into the data-link layer. The lower layer is called the physical layer, and depending on the transport network it can be DS I, DS3, FDDI (100 Mbps multi-mode fiber), or SONET/SDH. The two sublayers of the data-link layer which ATM standards define are called ATM layer, and ATM-adaptation layer. The 5 byte header of the ATM cell carries the address for the corresponding virtual path and connection, while the ATM-adaptation layer overhead is folded into the 48 byte cell payload. The adaptation layer performs key functions such as segmentation and re-assembly of user information, flow control, handling of

errors and service class definition.

Since the international network infrastructure is readily available to support broad-band applications, and desk-top coders are affordable and ubiquitous, the recent availability of off-the-shelf ATM switches will foster the emergence of many new international applications oriented initially, perhaps, to the needs of large corporations. As part of the network providers' broad-band networking efforts, AT&T has been testing the delivery of ATM signals over a combination of cable and satellite circuits with KDD, and Telstra. ATM-via-satellite has been tested in the lab environment by Comsat World Systems, between AT&T Bell Labs at Holmdel, New Jersey, KDD in Tokyo and Telstra in Sydney. The carriers hope that satellite links can be used for ATM transport to places hard to reach with fiber [8]. As part of the ATM trial, AT&T Bell Laboratories is conducting experiments with KDD for demonstrating the feasibility of carrying multi-media traffic over ATM networks internationally. Recently, the AT&T-KDD ATM trials have been expanded to include full motion video transmission between the two continents. A DS3 channel is allocated on a Trans-Pacific submarine cable for this experiment. As shown in Fig. 5, the KDD site at Shinju-Ku, Tokyo, and AT&T Bell Labs site in Holmdel, New Jersey, are connected via ATM switches. At the sending end, the movie server located at the Holmdel site transmits MPEG2-compressed video signals segmented into ATM cells. At the receiving end, the payload of ATM cells are reassembled with error detection and correction, and video signals are recovered and decompressed using a compatible MPEG2 codec which is developed by the video research organization in AT&T Bell Laboratories. This experiment is aimed at demonstrating the feasibility of sending real-time high-quality compressed MPEG video over ATM between the US and Japan.

Recently, AT&T Network Systems (NS) has defined a Broadband Networking Architecture (Net-2000) which enables international carriers to offer a flexible framework for broad-band networks [9]. Along with other ATM products, AT&T NS announced the GCNS-2000, their first cell-relay product, in January 1993. Many frame-relay networks are evolving into ATM networks, with overlay architectures initially. The public frame-relay networks have been providing an attractive alternative to leased lines, offering bandwidth on demand, and consolidating multiple logical links onto a single channel. Frame-relay technology is applicable only for rates up to 1.5 Mbps due to its protocol speed limitations. It is not suited for broad-band applications. Thus, the ATM, or cell-relay technology, is likely to rapidly penetrate into networks that currently deploy frame-relay.



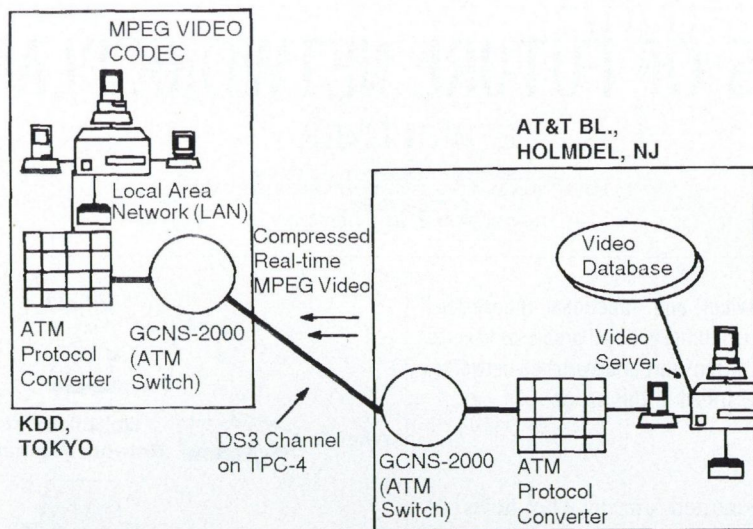

Fig. 5. AT&T-KDD Video-on-ATM Test Bed

## 7. SUMMARY

The most exciting aspect of true globalization of information technologies is a network to connect to every corner of the world and thereby enable the rapid exchange of information of all types: voice, data, image, text and video using compatible equipment and capabilities built according to the international standards. Fiber-optic submarine cables, maturing SONET/SDH standards for optical trans-

mission unified network operations with TMN, and broadband networking with ATM bring optimism, greater than ever before, that soon an exciting array of new information services will be available and affordable for the businesses and consumers of the world. With this paper, we highlighted the importance of these key dimensions of the international network infrastructure, and gave examples of the progress in the global arena.

## REFERENCES

- [1] L. D. Fossett, A. N. Kashper, S. Civanlar, and W. D. Radwill: Evolution of Routing and Capacity Management in International Switched Networks, *AT&T Technical Journal*, September/October 1992, Vol. 71, No. 5, pp. 13-24.
- [2] H. P. Katseff and B. S. Robinson: Predictive Prefetch in the NEMESIS Multimedia Information Service, *Proceedings of Annual ACM Multimedia Conference & Exposition*, San Francisco, California, October 15-20, 1994.
- [3] J. Davis, N. F. Dinn, W. F. Falconer: Technologies for Global Communications, *IEEE Communications Magazine*, October 1992, pp. 35-43.
- [4] Datapro Reports on International Telecommunications, July 1993.
- [5] R. J. Boehm: Progress in Standardization of SONET, *IEEE LCS Magazine*, May 1990, pp. 8-10.
- [6] CCITT Recommendation X.200, Reference Model of Open Systems Interconnection for CCITT Applications.
- [7] S. Allamagny, S. Civanlar, A. N. Kashper: Information Model for Capacity Management in Global Telecommunication Networks, *Journal of Network and Systems Management*, Plenum Publishing, March 1994, Vol. 2, No. 1, pp. 29-47.
- [8] D. O'Shea: ATM trial, *Telephony*, July 1994, pp. 1.
- [9] M. DeMaio, H. J. Kafka, M. D. Soneru, K. D. Tentarelli: AT&T Network Systems Service Net-2000 Broadband Networking Plans, *IEEE International Conference of Communications ICC'93, Conference Records*, Vol. 1/3, pp. 75-85.

**Warren E. Falconer** has both a B.S. and an M.S. in chemistry from the University of Manitoba, and a Doctor of Science degree in chemistry from the University of Edinburgh, Scotland. He is the Executive Director of the International Communications Services Center at AT&T Bell Laboratories and Chief Technical Officer for the International Operations Division.

**Seyhan Civanlar** has both a B.S. and M.S. in electrical engineering from the Middle East Technical University in Ankara, Turkey, and a Ph.D. degree in electrical engineering from North Carolina State University in Raleigh, North Carolina. She is a Distinguished Member of Technical Staff in the Global Network Planning and Engineering department in AT&T Bell Laboratories.

**Neil F. Dinn** has a B.S. from Northeastern University, and an M.S. from Massachusetts Institute of Technology, both in electrical engineering. Currently, he is the head of the Global Network Planning and Engineering department in AT&T Bell Laboratories.

**Gerard P. O'Reilly** has a B.S. in mathematics from Manhattan College, New York, and both an M.S. and an Eng.Sc.D. in operations research from Columbia University, New York. He is a Technical Manager in the Global Network Planning and Engineering department in AT&T Bell Laboratories.



# ASPECTS OF FUTURE NETWORK PLANNING

E. WOLLNER

DEUTSCHE BUNDESPOST TELEKOM  
FORSCHUNGS- UND TECHNOLOGIEZENTRUM  
P.O. BOX 100003  
D-64276 DARMSTADT, GERMANY

Owing to competition, new services and functional innovations introduced in telecommunications equipment, novel problems have to be faced in the future by planners of transport and switched networks. Some of these problems will be described in this article.

## 1. INTRODUCTION

Telecommunications is reckoned among the fields of maximum growth and there is no doubt that a country's efficient telecommunications infrastructure accelerates both the national development and worldwide trade with that country. In addition to the classic telephone service, a series of novel services are being developed at present for the purpose of exchanging all types of information: Apart from voice communications, these include the transmission of data, documents and images as well as multi-media applications. The ultimate objective is to provide access from everywhere in the world to any person wherever he or she may be in order to exchange information.

The necessary resources are provided by telecommunications networks. As long as the traffic load contributed by the new services is negligible measured against the conventional telephone service, the planning of this one-service network can be performed in the same way as before. In this article we will discuss the aspects to be considered by network planners in the future and the types of new problems to be faced in contrast with classic network planning.

The following section will, therefore, deal with the elements determining the planning of one-service networks. Section 3 is intended to give details of expected changes which require the planner's response. Various problems to be faced in the planning of future networks will be listed in section 4. This will give evidence of the fact that the suitability of future networks for broadband communications is not the main problem.

## 2. ELEMENTS OF ONE-SERVICE NETWORK PLANNING

Classic network planning is probably performed both efficiently and effectively by all network operators. This is due to the situation to be evaluated which, because of long years of observation, appears to be stable, easy to survey and calculable. The approximations required for the network design can be assessed with respect to their consequences and errors. The investment decisions are supported and confirmed by traffic measurements.

Network planning has to find answers to the following essential questions: When? Where? What? How much? i.e. it is necessary to define the time, location, type and amount of investments for the design of telecommunications networks both economically and in keeping with the demand.

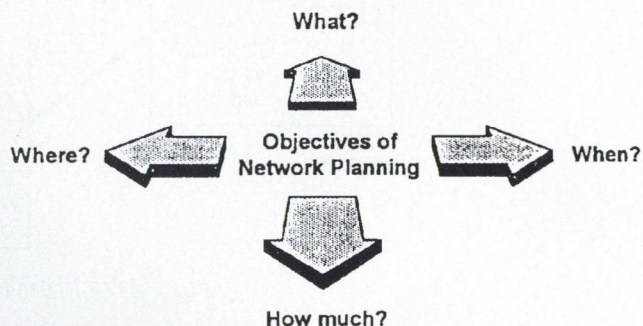

Fig. 1. Network planning objectives

These activities involve different planning stages (see Fig. 2):

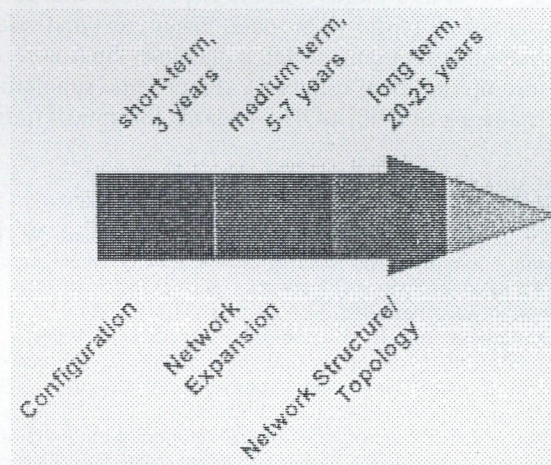

Fig. 2. Network planning stages

Moreover, the planning refers to different network areas: local, regional, long distance. A common feature shared by all these planning tasks is the need to solve

- problems of demand forecast
- problems of locations and network structures
- problems of equipment dimensioning.

In the case of one-service networks (involving a single operator for the switched and transmission networks!), it is possible, for instance, by means of logistic functions, to derive forecasts of future subscriber numbers from the development of the numbers of subscribers of telephone main stations and private branch exchanges. Traffic measurements give evidence of the traffic volume generated by the subscribers, the routes taken by this traffic and its distribution in time. As long as the subscribers' behavior is homogeneous and the environment remains stable, it is possible to derive a point-to-point traffic matrix on which to base the planning of the switched and transmission networks.



### 3. CHANGES REQUIRING ACTION TO BE TAKEN BY NETWORK PLANNERS

In this section, we will only in brief refer to the phenomena which presently have reached a more or less advanced state in all countries and involve changes to classic network planning:

- Regulatory measures. Several competing network operators offer transmission capacity, various carriers offer telecommunications services to the public or closed user groups.
- New services. Other services emerge in addition to the plain old telephone service which differ in the bandwidth required, traffic characteristics and/or grade of service.
- New functions. Communications is made more comfortable by technical improvements of terminal equipment offering service features such as repeated calling, addition of further services to communications in progress, mobility, etc. New functions provided by the equipment (cross connectors, add-drop multiplexers, ATM, etc.) allow the network resources to be used more flexibly.
- Traffic management. In order to enable different services transmitted in an integrated (broadband) network to make common and fair use of the network resources, appropriate procedures have to be implemented at the network interface (UNI) and within the network for the purposes of call acceptance and parameter control. Additional precautions are necessary to avoid overload caused by a single service or overload of a single node.
- Demand for communications. In addition to individual communications between two subscribers using two channels of identical bandwidth in the forward and backward directions, there are other types of communications:
  - multi-party service, i.e. demand for point-to-multipoint traffic
  - demand for one-way traffic (such as broadcasts) requiring only one channel
  - asymmetric demand requiring channels of different bandwidths in the forward and backward directions
  - subnetworks of carriers meeting particular availability requirements.

### 4. NETWORK PLANNING PROBLEMS

Some of the phenomena listed in Section 3 only change the network planner's point of view whereas others give rise to novel planning problems.

#### 4.1. Time-related problems

Time horizons are becoming narrower because of decreasing innovation cycles, the sudden appearance of new requirements, the need for a closer orientation towards the market and the response to pressure applied by competitors and the expectations of the customers. The realization of a plan and the hardware implementation, however, will always take some time and, thus, imply a minimum duration of short- and medium-term planning intervals. Long-term planning will, in general, become less important because the constraints to be accounted for by the planner cannot be assumed to be stable for longer periods.

Strategic planning, on the other hand, will obtain a new and decisive significance. Network models are used to investigate the introduction of new equipment performing different functions, new network architectures, new management procedures, new routing procedures, new services, increased availability, etc. These models give characteristic descriptions of the corresponding overall network, accounting for the cost of investment, management and operation and of the expected revenues and profits. These strategic considerations also involve new requirements to be met by the planning result (as regards, for instance, the robustness of a network, flexible configuration, easy expandability, etc.)

#### 4.2. Network structure

The number of network levels will be reduced to the access network level and the long-distance network level. There will, however, be several access networks for different services which may also differ in size. This will give rise to new problems for the planning of locations of concentrators performing different node functions, capacity limitations, multiple connections to exchanges, etc.

The classical network decomposition will have to be changed for other reasons, for example, because subnetworks (operated by carriers) must be additionally planned in the transmission network. Moreover, it is worth considering to what extent network planning should be performed separately for each layer (physical, path, circuit) to what extent the requirements and results achieved in different layers influence the planning in other layers and to what extent it may even be necessary to find common planning approaches which are not restricted to single layers.

#### 4.3. Problems of demand forecast

Forecasts of the demand (of a specific service) will become a basic problem. Owing to the interaction of several carriers, forecasts of the overall demand do not include sufficiently specific information. Moreover, it is necessary to make allowance for a service being replaced by others. Forecast procedures have been developed for such constellations which are, of course, well-known in other fields of economic activity. In telecommunications, however, it is not only necessary to estimate the size of a demand but also its geographical distribution and even the source-sink relations including their bandwidths, distributions in time, etc.

In this situation, it may well be that the only remedy is a changeover from demand-oriented to profit-oriented network planning. The network operator or carrier takes a business risk and estimates the services he expects to sell in the telecommunications market. According to his assessment, he plans his network. His marketing section faces the task to fill the network capacities made available by planning and corresponding implementation. This interaction between planning and sales which is much stronger than in the case of the conventional approach gives, of course, rise to novel ideas. Fast reactions in the market will only be possible if sufficient spare capacities are provided. In this situation it will probably be helpful to perform profit



and loss as well as risk analyses to obtain further data supplementing the forecast.

#### *4.4. Problems of transport networks planning*

The problem does not consist in the additional consideration of demands for larger bandwidths. The network planner has to deal with both a point-to-point demand matrix and successively with several demand matrices corresponding to the different bandwidths required.

New problems arise from the additional consideration of other phenomena listed in section 3.

Network operators and carriers pursue different goals in their network planning activities.

Network operators will install, wherever possible, network equipment in such a way as to make these resources available for all presumable applications (telecommunications services, leased lines). As mentioned above, the implementation will require a certain lead time before it is possible to sell these transport capacities in the market. Transport capacities booked in advance will obviously be sold at lower prices than capacities booked at short notice. Such economic constraints will have their impact on the transport networks planned by network operators.

A carrier will make optimum use of the network leased from an operator before leasing additional resources. The network expansion can be performed practically without delay, although possibly at a higher price. In the carrier's network planning model, this situation must probably be described by special target functions for which efficient solution methods are still unknown.

If the resources of the transport network are jointly used for different services having different busy hours, a problem will arise in transport network planning which is well-known from the planning of switched networks with several time windows, i.e., the problem of determining the network resources in such a way as to make them usable for different demand matrices. Accordingly, it can be foreseen that — above all, because of the demands of carriers for special subnetworks — increased availability requirements have to be met which can be implemented optionally by the network management of the transport network or by increasing the number of independent routings. Procedures used for transport network planning must also be suitable for dealing with the different types of communications demand mentioned in section 3.

Owing to the use of electronic cross connectors (SDH-CC, ATM-CC) it is possible to apply capacity management functions in the transport network which have to be accounted for in the planning process. The customer's demand for a higher network availability but also the possibility of customer-controlled networks imply close interrelations between network management and network planning. Particular attention has to be paid in this context to the planning and utilization of the standby network even simultaneously with the operating network. Here it is desirable to create appropriate frameworks for planning states between network management and network planning to avoid competing actions originating from planning and network management. The new configuration possibilities in the network will also influence

medium-term planning: Rerouting of existing connections in accordance with the network management may allow the utilization of existing resources to be optimized. These and other necessary expansion investments are jointly dealt with by medium-term planning.

Another new problem encountered in this field arises from the planning of the use of electronic cross connectors performing different functions. The connection of the transport levels (2 Mbit/s, STM 1, etc.) at the nodes involves the need to deal simultaneously with networks having the same number of nodes, but different numbers of edges. This is due to the fact that the allocation of equipment at a certain level influences the planning problem at another level and viceversa.

#### *4.5. Problems of switched network planning*

Planning of integrated multi-service broadband networks involves much more unsolved problems than planning of the transport network.

Owing to differences in the services with respect to bandwidth demand, traffic characteristics, grade of service, traffic volume, busy hour and geographical distribution, it is necessary, for a carrier wishing to make effective use of his network, to find criteria recommending either a complete integration, i.e. unconstrained access to the network resources or partial integration, for instance, by assigning priorities for the access of different services or the setting-up of various separate networks.

Because of the presence of several services in an integrated network, it is necessary to take organizational measures governing the joint utilization of the network resources. This refers both to the elaboration of such principles and the evaluation of their efficiency. It is still an open question what call acceptance mechanisms should be employed for certain services and what defensive actions should be taken against overload caused by single services. The task to be performed by teletraffic theorists is the analysis of the efficiency of multi-service networks, of traffic load and individual grades of service in a large number of different scenarios which, in addition, account for various routing possibilities and traffic management principles. This is the prerequisite for adequate functional descriptions and approximations which are necessary for the careful design of multi-service networks.

The signalling network has to fulfil much more comprehensive tasks than in the case of a one-service network, the more so if functions of the intelligent networks and mobile subscribers/terminals are performed. The locations where to install equipment with centralized or distributed information and intelligence have to be determined by planning which must also account for the load to be carried by the signalling network and bounds for the access times.

A novel and complex task is the planning of virtual paths in multi-service ATM-networks. It is desirable that a maximum capacity be grouped in a virtual path in order to make optimum use of the effects of statistical multiplexing. In this context, it is also necessary to study and define a routing concept accounting, among other things, for the unequal development of the costs of node and edge equipment.



This reasoning throws light on the close cooperation between the switched network and the transport network because the virtual paths, once defined, concentrate large capacities in the transport network. The implementation of large-scale transmission systems which are not interrupted by cross connectors has its influence on the economical planning of the virtual paths. This is indeed the field where the optimum overall network solution has to be found.

Such interdependences are also recognizable in other areas. The traffic management activities, for instance, which are undertaken in the switched network and in the signalling network have to be harmonized in such a way that no contradictory effects are produced. It is also necessary to mutually adapt the network management actions taken in the transport network and the traffic management actions required in the switched network to allow, for instance, in the event of a breakdown of transport capacity, the activation of stand-by capacity to be supported by rerouting in the switched network.

## 5. CONCLUSIONS

It is because of regulatory measures, new services, new functions of terminal equipment, network and traffic management activities and a changing demand for telecommunications that network operators and carriers will have to solve a large variety of new planning problems in the future. Not all examples discussed in this paper are of equal significance. It is, however, obvious that tomorrow's planning problems will be more complex and solutions to a particular problem have to be found very quickly to ensure survival in the telecommunications market. Apparently it is necessary for network planners to develop versatile planning tools in order to be well prepared for the new tasks they are facing.

## 6. ACKNOWLEDGEMENT

The author wishes to thank his colleagues Dr. P. Heuer, Dr. R. Kleinwillinghöfer-Kopp and J. von Puttkamer for stimulating discussions and comments on this article.

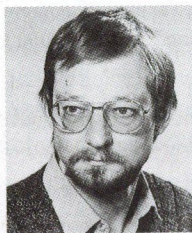

**Eckart Wollner** graduated in mathematics at the Julius-Maximilians-Universität in Würzburg in 1968. After his examination he joined Deutsche Bundespost Telekom where he has been working up to now at the Research and Technology Center (FTZ) in Darmstadt. At present, he is heading the Research Group "Network Optimization". His fields of interest and research include modelling of planning problems, network reliability, traffic theory and operations research.



# CONTINUING PROFESSIONAL DEVELOPMENT FOR TELECOMMUNICATIONS ENGINEERS

K. WARD

UNIVERSITY COLLEGE  
LONDON, UNITED KINGDOM

This paper makes a case for the continuing development of telecommunications engineers and postulates how it should be carried out. It argues that such education should encompass the market and commercial dimensions of the industry as well as engineering. Also, it recognises the time pressures on engineering managers and makes the case for part time education using multimedia applications.

## 1. INTRODUCTION

The continuing professional development of telecommunications engineering is becoming increasingly important not just to keep pace with technological development but also to adapt to a new telecommunications environment of privatization, liberalization of the market and hence competition together with regulation. These factors place demands on mature engineers far removed from their traditional university experience, and underlines the need for subsequent and rather different professional training.

It has been suggested (IEE News, Sept. 1994) that the half life of engineering degrees is as little as four years and that 60 % of technology that will be in use by the year 2000 has not yet been invented whilst 80 % of people that will be employed at that time, are currently in work. This, by itself, is a compelling need for continuing education. However, the radical changes taking place in the telecommunications industry where operators are moving from state owned monopolies to privatized companies operating in a fiercely competitive market is widening the role of engineers. The decisions made by engineering managers can have a significant impact on the financial performance of their company which is profit driven. Unfortunately mature engineers are all too often ill equipped to perform that role well because of their singular technology focus. It is therefore not surprising that the probability of an engineer rising to the most senior company positions is not as high as those who specialise in finance, marketing or law. The paradox is that the process of logical reasoning and analysis, as practiced in engineering or science, is essential when managing a large and complex organization. Continuing professional development of the engineer can help restore the balance.

The aim of the education process should be to widen understanding across a range of telecommunications technologies, to deepen understanding of the principles that underlie the business process in the new environment, and to develop the technical to business connections.

## 2. THE NEW TELECOMMUNICATIONS BUSINESS

The business dimensions of industry are becoming in-

creasingly complex and characterised by their interactive nature.

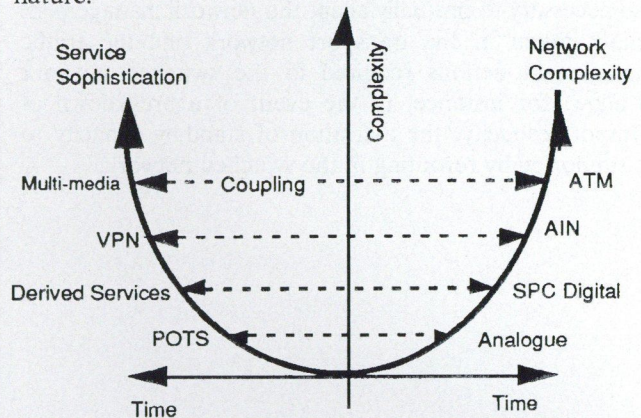

Fig. 1. Network and Service Relationships

For example, the increasing complexity of networks as they evolve from analogue through digital to intelligent network platforms and thence to broadband ATM is driven by market demand for ever more sophisticated services. The coupling is shown in Fig. 1 where, for example, the Advanced Intelligent Network (AIN) platform is shown supporting the Virtual Private Network (VPN) service. There are, however, a number of other parameters that interact with the network and services it supports. They are

*Customers* – characterised by the market segmentation and generating demand for services and value for money (in terms of price and quality).

*Telco business* – representing the profit from the individual services.

*Globalization* – which deals with the global dimensions of the service/network.

*Competition* – which may require service differentiation in order to obtain market share.

*Regulation* – which may set limits on how the service is provided and the type of competition allowed.

The example in Fig. 2 shows how a virtual private network (VPN) service can be provided on an intelligent network platform to meet the needs of major customers who wish to outsource their private networks. But should the Telco wish to go global to protect the revenue from its own multinational customers (MNC's) and generate further revenues from MNC's based in other countries then it may wish to offer a global VPN service. Competition may occur if the Regulator opens access to the Telco's network (Open Network Architecture, ONA known as Open network Provision, ONP in Europe) for Value Added Services



Operators to offer VPN services.

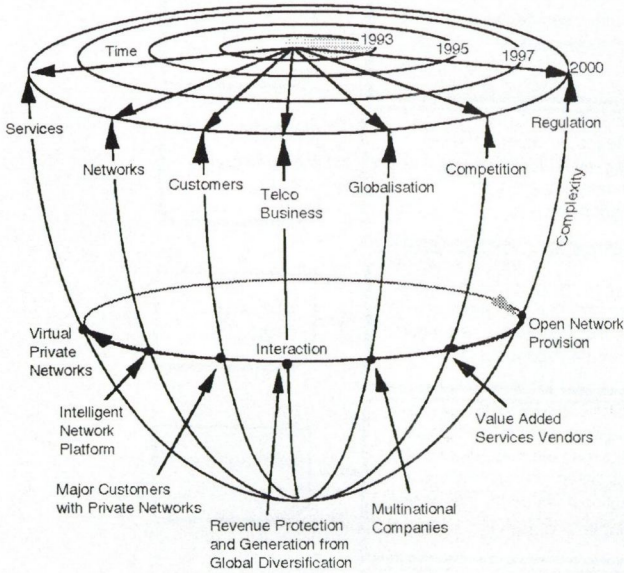

Fig. 2. Telecommunications Complexity Hemisphere

Complexity increases with time along all of the many parameters that interact and drive the telecommunications business. Thus the expanding surface area of the hemisphere illustrates the continuum between each parameter plot, since there are close interactions between each parameter. Therefore it represents the increasing business

complexity with time. The area also illustrates the increasing understanding that telecommunications engineering managers will need to possess if they are to maximise their effectiveness to allow their companies to grow and prosper. It therefore follows that the continuing education of engineers must encompass all of the complexity parameters and their interaction.

Consider the simplified model of the telecommunications industry as applied to a telecommunications operator (Telco), shown in Fig. 3. In a privatized, liberalized and competitive environment, business performance is driven by profit growth and market share is important since it generates revenue. But, the network is an important internal revenue driver since its costs influence tariffs, its performance influences quality of service and its capability determines the service portfolio. The network also consumes a major proportion of operating costs and generates much of the need for capital. Hence the modules in the model should form the basis of the syllabus for educational programmes for mature engineers in the telecommunications industry.

A more detailed syllabus may be constructed from the model in Fig. 3, starting from the objective of providing a comprehensive understanding of the telecommunications business with its dynamic interactions and internal and external drivers. This is illustrated in Fig. 4 which demonstrates how the main objective can be decomposed into sub-objectives with their topics which then form the basis of the syllabus modules.

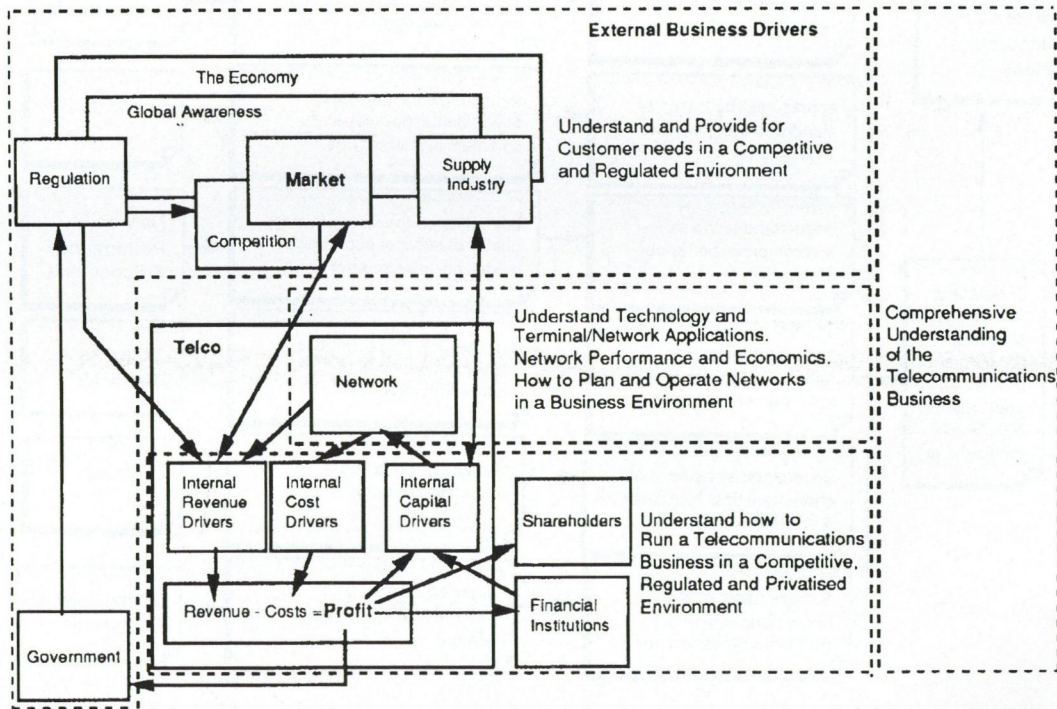

Fig. 3. Simple Telecommunications Business Model



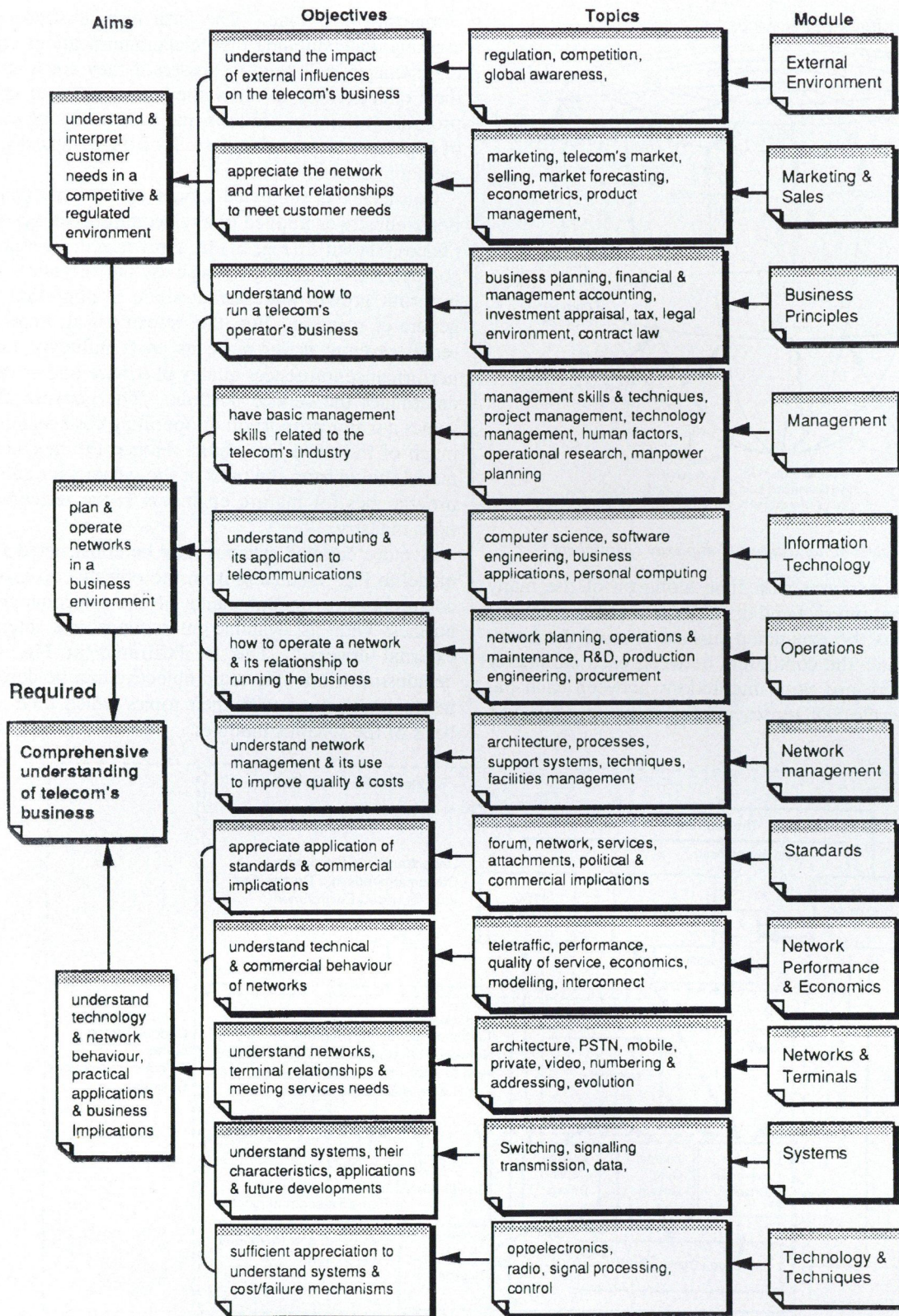

Fig. 4. Curriculum Structure and Design Principles

### 3. EDUCATIONAL METHODOLOGY

The educational methods for mature engineering students differ from those employed in university undergraduate courses. The aim, in the case of the university undergraduate, is at least to build up basic skills in mathematics, analysis and scientific logic and to develop a base of knowl-

edge in one major branch of engineering (e.g. electronic or mechanical engineering etc.).

In the case of further professional education for the mature engineer in the telecommunications sector, three main aims are to:



- encompass the major fields pertinent to telecommunications engineering;
- build a thorough understanding of the telecommunications business process;
- establish the connection between engineering and business issues.

In achieving these aims there is a conflict between breadth and depth; the breadth of what is proposed is significant. It is arguable that an attempt is being made to put the engineer through at least two further degree courses. But too extensive a course comes into conflict with the time a professional engineer has available to spend on further study without adversely affecting their career. To make the connections satisfactorily it is essential that the breadth of activities across the business of telecommunications be encompassed, it is the depth of the educational process that inevitably has to be sacrificed to some extent. However such a broad coverage will better equip the student to identify the critical areas which need investigation in more depth. It is the very maturity of the professional engineering student that can make this process feasible.

The design philosophy of an educational programme for mature telecommunications engineers is that it should:

- Build students knowledge in a logical manner starting with the finance and marketing aspects so that in subsequent, technology and network oriented segments, delegates would always relate back to the business implications and market applications of the subject.
- Be application oriented and experiential to relate the theory to the practice of running a telecommunications operating business. This can be achieved by such things as a specially designed competitive telecommunications simulation i.e. business game, which should run throughout the programme and phased to integrate with lectures so that, for example, marketing theory lectures are followed by exercises to produce market forecasts, product plans etc.
- Have lecture topics covered by a subject matter expert but also reinforced by a "practising manager" from the industry working in the area of the subject who debates the practical issues with students.
- Add value to the company for whom the student works, over and above the educational value. This may be achieved by requiring the student to undertake a number of major projects plus their dissertation. Each project should be sponsored by a senior manager in the company and requiring the student to undertake a practical investigation, the resulting report being circulated to interested people in the company. Projects should encompass network, finance and market related aspects such as design of new network platforms, financial analysis of network operations, determination of communications requirements of specific customers etc.
- Encourage team working by extensive syndicate exercises. Syndicate members should be selected to give a balance of experience so that they contribute to each others education.
- Have high intellectual requirements and be assessed so that students are required to cope with a good deal of pressure to successfully complete the course.

Coping with pressure is symptomatic of the modern telecommunications business. A useful intellectual benchmark is a Masters degree; indeed, validating such a course for the award of such a degree has the merit of giving successful students a tangible and externally recognised reward and also subjects the course to regular quality checks to maintain standards.

#### 4. PART TIME EDUCATION

Clearly, full time education gives a student the best pedagogical experience and as such, a telecommunications MSc should occupy at least one year of intensive study. However, such an absence from work is becoming increasingly difficult to arrange for a mature engineer, both from the employers perspective in losing a valuable resource in a time of high work load; also from the students point of view due to the domestic disruption and loss of business continuity.

It is therefore necessary to seek alternative means of part time education that, as far as possible, mirrors the advantages of a full time course. This is becoming more achievable using the emerging technology that telecommunications customers are clamouring for, namely, multimedia communications.

#### 5. TECHNOLOGY BASED TRAINING

Technology Based Training (TBT) learning is not a new technique, for some years distance learning has been carried out using tools such as interactive video disc, remote video conferencing, TV (including satellite) and radio broadcast, computer based instruction and intelligent tutoring systems. However, the emergence of the multimedia (audio, text, fixed image and motion video) PC and networking capability offers a much richer interoperation of media type, information storage and retrieval, and networking flexibility; hence a more powerful set of educational tools. Additionally, present trends indicate that prices will continue to fall and power increase for many years to come. Therefore, high quality technology based training is now a reality even though it has not been embraced with any enthusiasm by academia.

It can be argued that distance learning using TBT tools can never replace the interactive, dynamic face-to face experience of the lecture theatre. Never-the-less, used wisely in conjunction with the right balance of residential and remote learning it can bring the benefits of a part time course close to that achieved by full time education.

#### 6. TBT TOOLS

*Packaging* — of multimedia material from a variety of sources is becoming easier and cheaper with the emergence of more user friendly authorware software. This will allow academics to create their own material in as routine a manner as today's lecture notes. Additionally, the power of moving graphics combined with video will allow complex subjects to be taught in a more understandable manner. But such packaging is still in its infancy and it is estimated that lecture preparation would currently take more than



double the time of conventional material. It can be expected that a number of new entrants to the education field will emerge to provide generic and tailored multimedia packages distributed by CD-ROM or the telecommunications network in competition with paper based material from the publishing industry.

*Distribution* — Material can be distributed to a remote location via the telecommunications network or physically via CD-ROM. The latter is currently most used with discs that can now hold more than 60 minutes of video material and considerably more of mixed media. They are cheap to produce (<£1 per copy) and are robust for transportation. However, network based solutions such as videoconferencing and multimedia client-server systems are becoming increasingly more viable for education. Adequate network platforms using ISDN and copper (ADSL and HDSL) based access to intelligent digital networks are becoming more widespread and economical. In the longer term, it is expected that fibre access to ATM based B-ISDN systems will produce significant improvements in quality, flexibility and economics.

*Messaging* — E-Mail is well established for text and in world wide use by academics via networks such as Internet. But it can be expected that multimedia enhancements will be developed allowing media files to be "drag and drop" exchanged on line.

*Display* — PC's already in use for trainee's main job functions are increasingly being equipped with multimedia capability for virtual team working using "Groupware" applications. Such machines can have an auxiliary use for education and linked together to share a variety of media type such as, 2-way video image, audio, slide/graphic, video drawing space ("chalkboard"), and shared applications such as spreadsheets.

## 7. USE OF TBT

*Videoconferencing* — may be used in a variety of combinations to link live lectures to remote classes to overcome geographic separation and venue or audience size limitations. Enhancements by the use of multimedia and shared applications assist the education value but there is a feedback problem without the live environment where participants can not sense the state of the class. Participants must also familiarise themselves with the new social conventions required for successful interaction which require a more disciplined approach. In future, large screen technology to create a more realistic "telepresence", where all participants can be seen, will be more powerful.

Desktop conferencing with widely dispersed participants is more successful when the members of the team are familiar with each other and a period of team building before launching into virtual working is to be recommended.

The potential problems of simultaneously managing the

technology and lecturing should not be ignored. An inadvertent wrong keyboard operation could lose the material and wreck a lecture. However it is to be expected that simpler human interfaces and protocols will be developed to minimise such a risk.

*Computer Based Instruction* — comprises software packages of pre-configured training material networked to individual PCs/workstations. It can include recorded lectures, course notes, exercises and tests, research material (text, graphics and video), experimental models and simulations, case studies etc. This is a useful training tool but is most effective when used in conjunction with face to face (using video conferencing if necessary) tutorials.

*Intelligent Tutoring Systems* — with some form of artificial intelligence are well established to offer individual students interactive computer based education customised to suit the style and pace of individual students. But they are currently complex and expensive to develop.

*Network Accessed Databases* — are a valuable tool for research and the use of network based "Intelligent Agents" as a context sensitive help facility to navigate to the relevant database will be of significant assistance. Such electronic libraries will cut down the time for research which will be more comprehensive and better linked to enhance the quality of projects.

*Desk Top Publishing* — is now a well established tool in its various forms of word-processing and graphics, and being continually enhanced to make it more powerful and user friendly. Its use can result in significant productivity improvement in the production of lecture material and student reports, their visual quality and ease of assimilation.

## 8. STRUCTURE OF A PART TIME PROGRAMME

A part time programme for mature telecommunications managers covering the syllabus outlined in Figs. 3 and 4 at "Masters" level could be of 2 years in duration with a balance of residential and distance learning. The structure of such a programme is shown in Fig. 5.

In the example shown, there is only 3.5 months of residential education which therefore has to be used wisely to obtain maximum pedagogical benefit. Lectures should therefore be of the more advanced aspects of a subject, the basic aspects being dealt with by distance learning. Other aspects dealt with on the residential modules are shown in Fig. 5. It is suggested that the first residential module be relatively long period, say, one month, in order that adequate team building can be carried out to achieve effective virtual team working in the non-residential periods. It also allows the consolidation of the basic understanding of the telecommunications business necessary for students to work alone or in virtual teams during the non-residential periods.



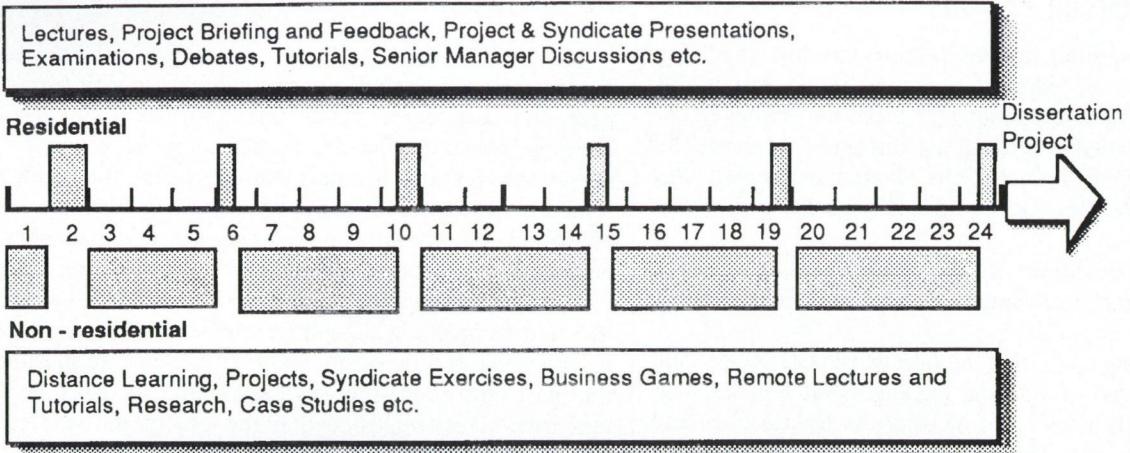

Fig. 5. Possible Structure of a Telecommunications "Masters" Programme

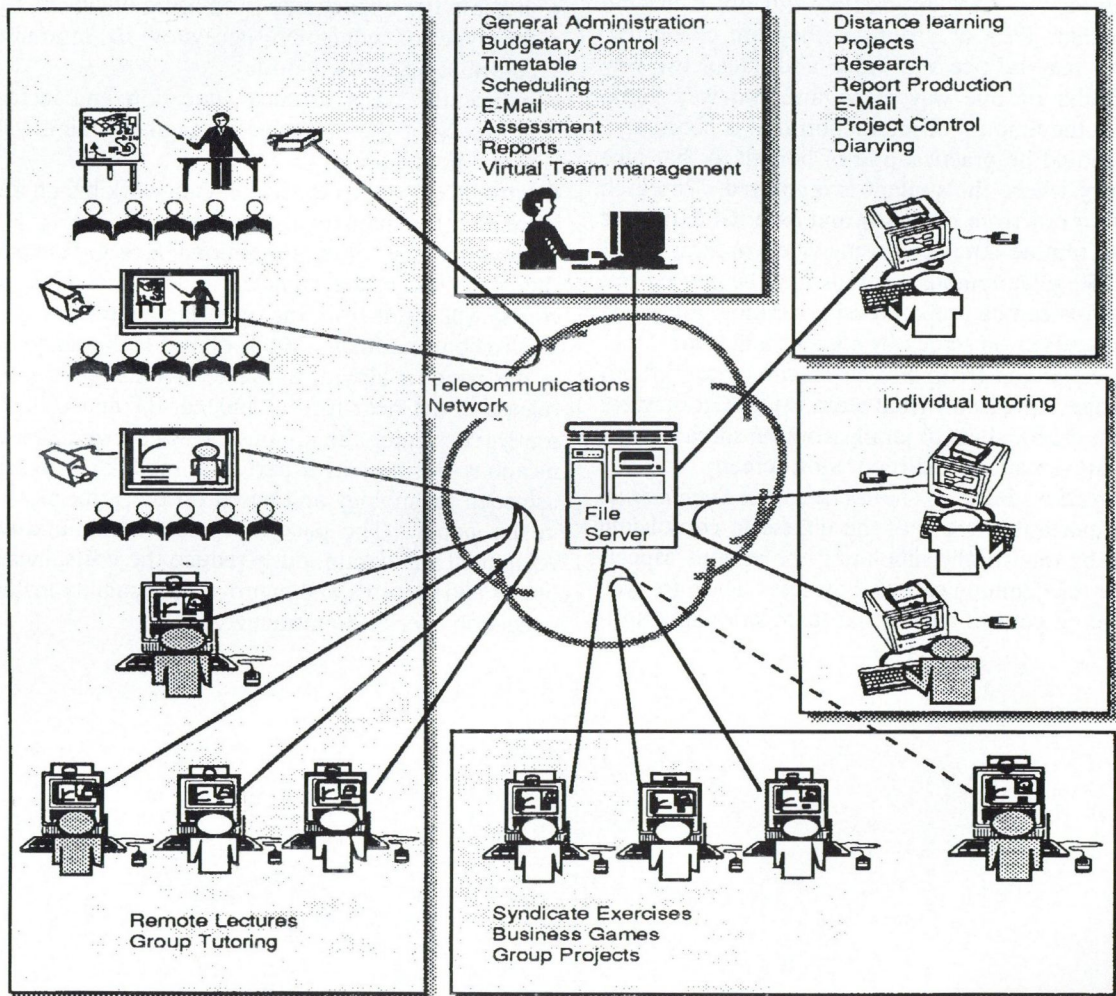

Fig. 6. Virtual "Masters" Programme



## 9. NON-RESIDENTIAL PERIODS

The non-residential periods require careful scheduling and supervision in order to reap maximum benefit. A number of E-Mail, scheduling and project management packages are available to facilitate this and they should be available to faculty and students via the file server. An illustration of the way such periods may be run is shown in Fig. 6.

Students will obviously need to be keyboard literate with reasonable typing proficiency. Areas well suited to these periods are:

*Distance learning* — using a variety of CD-ROM and network delivered multimedia packages but scheduled to a timetable with assessment of progress by exercises and remote tutorials. Needless to say, the course will inevitably migrate to a paperless programme with traditional lecture notes stored in the file server. Modelling and simulation exercises can be remotely controlled via the file server.

*Remote lecturing* — can be carried out to individual students via their PC's or groups if they are collocated. Such lectures may be one way video and audio, two-way video and audio or one way video and two way audio depending on the amount of interaction that is necessary.

*Projects* — should be practical and of benefit to that part of the industry where the student is employed. Research may be carried out from company and external databases together with remote interviews using videoconferencing if convenient. Regular remote tutorials may be carried out and draft reports can be prepared using desktop publishing and jointly discussed on screen by student and tutor.

*Syndicate exercises and group projects* — can be carried out by students operating as a virtual team using "Groupware" packages that enable them to jointly work on spreadsheets, multimedia presentations and reports on screen.

*Telecommunications Business Games (Business Simulations)* — are an important element of the course to consolidate the learning by realistically simulating the various aspects of running a telecommunications business. They are well suited to remote control and virtual team working if software based.

## 10. CONCLUSIONS

There is a clear case for continuing professional development of telecommunications engineers arising from the pace of technological development together with the increasing pressures that are accelerating the processes of telecommunications business change. Given the highly interactive nature of the telecommunications business, such education should aim at broadening the understanding of engineers rather than deepening their specialization. However, the increasing competitive and financial pressures on the industry make it difficult to release valuable engineers to undertake full time education. It is therefore inevitable that part-time education will assume an ever more important role. It is suggested that the use of the very technology and services provided by the telecommunications industry provides the means of achieving high quality part-time education that will:

- approach that provided by full-time education;
- increase the opportunity for mature engineers to obtain the type of education necessary to maximise their contribution to the industry;
- reduce the costs of such education and increase the efficiency of the academic community, there will be no global boundaries;
- introduce students to virtual team working, an inevitable trend in the industry and its customers.

However, the value of traditional face to face education should not be underestimated and a successful part time course will result from the optimum balance of residential and remote modules. Much of the technology described in this paper is already available or underdevelopment for release in the near future. Indeed, BT and UCL are currently redesigning the in-house MSc course in Telecommunications Business as a part-time modular programme to use such technology and based on the principles outlined in this paper. The pace of IT and communications development will continuously reduce the costs, increase the power and features and improve the usability making such education ever more attractive.

**Keith Ward** retired from BT at the end of 1992 after a career of 44 years during which he rose from apprentice to Chief Engineer responsible for planning and implementation of BT's UK network. During the latter years he developed and ran the BT Telecommunications Masters Programme for high potential BT middle managers as its Dean of Studies. He is now employed by University College London as Visiting Professor in Telecommunications Business where he is involved in running full time and part time MSc courses in telecommunications engineering and business studies.



# NETWORK EVOLUTION IN A COMPETITIVE ENVIRONMENT

J. ORLANDO, G. THURSTON

SWITCH NETWORK PLANNING  
BELL-NORTHERN RESEARCH  
P.O. BOX 3511, STATION C  
OTTAWA, ONTARIO, CANADA, K1Y 4H7

S. OXNER and M. CULLUM

NETWORK PLANNING  
STENTOR RESOURCE CENTRE INCORPORATED  
160 ELGIN STREET, SUITE 700  
OTTAWA, ONTARIO, CANADA, K1G 3J4

The impact of increased competition on the network architecture of an incumbent telephone operating company is examined. A top-down analysis is performed in which: (i) the increasingly competitive telecommunications industry is analysed, (ii) a proactive response by the incumbent is recommended, (iii) the resulting impact on its existing network architecture is determined.

## 1. INTRODUCTION

This paper describes the impact of competition on the network architecture of a service provider previously operating as a monopoly and provides network deployment recommendations that enable the newly competitive service provider to meet new service and business objectives. The paper is divided into three main sections, corresponding to a top-down analysis (Fig. 1). First, the increasingly competitive telecommunications industry is analysed and the impacts of emerging technologies, changing business factors and increased user sophistication are examined. Next, a proactive telephone operating company response to competition is proposed. Finally, a corresponding network architecture evolution strategy and deployment recommendations are provided to enable operating companies to meet the business challenges of the 1990s.

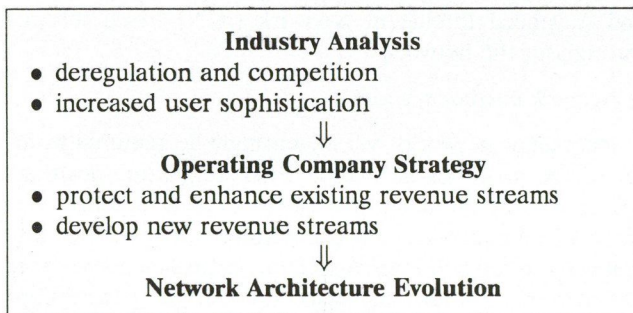

Fig. 1. Top-down analysis to determine network architecture evolution. (i) The changing industry structure is analysed. (ii) A proactive response to competition by the incumbent is recommended. (iii) The impact on the network architecture is described.

## 2. INDUSTRY ANALYSIS

Several factors are altering the traditional telecommunications environment. Deregulation, enabling competition, is occurring at a rapid pace in many countries. Technology performance is increasing at an exponential pace. End-users have requirements that are increasingly diverse, sophisticated and use higher bandwidths. The impact of these trends on incumbent telecommunications service providers is examined.

## 2.1. Deregulation and Competition

Several countries have modified their regulations to allow competition in telecommunications services, and many others are considering similar changes in their legislation [1]. Generally, deregulation is structured so that competition emerges in phases-cellular, toll, access, value-added services and finally local switching. New competitors emerge at each stage of deregulation and benefit by targeting only the most profitable segments of a traditional operating company's business.

In this environment, the incumbent telecommunications provider must be services driven to remain competitive. This creates a focus on rapid introduction and deployment of new services.

## 2.2. Increased Technology Performance

A second trend in the telecommunications industry is the exponential increase in technology performance, as evidenced by lower costs for bandwidth, processing power and data storage technologies. For example, end-users today enjoy a desktop computer with the processing power equivalent to a 1980 mainframe system.

This sophisticated technology has also found its way into the service provider's environment. In a regulated environment, the life of capital infrastructure investment is dictated by a regulator, while in a competitive environment it is set by competitors' strategies, technology evolution, and service trends. In such an environment, equipment is replaced more rapidly and must therefore be depreciated more quickly. Thus, in a competitive environment, the management and timely deployment of new technologies becomes a strategic factor.

## 2.3. Increased User Sophistication

A final trend in global telecommunications is the increase in user sophistication, diversity, and bandwidth requirements. End-users demand a wide variety of telecommunications services, including:

- higher bandwidths,
- customized services,
- control and manageability,
- reliability and survivability,
- simplicity of operation,
- globally ubiquitous services,
- increased mobility.

To remain competitive, a service provider must introduce new and innovative services at a rapid pace.



### 3. OPERATING COMPANY STRATEGY

In a restructuring telecommunications industry, it is recommended that an established operating company pursue a proactive response to competition (Fig. 2). In a monopolistic environment, business cases are typically driven by factors such as capital requirements and savings that would be achieved in operations, administration and maintenance (OA&M).

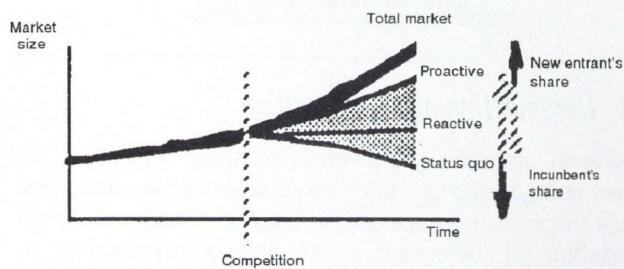

Fig. 2. Market share in a competitive environment. When competition begins, an incumbent service provider can adopt a proactive strategy and therefore increase its potential market share. Maintaining the status quo will result in a reduced market share.

As competition is introduced, and competitors target specific high-value market segments, revenue protection becomes the key deployment driver. In such an environment, deployment planning is said to be *reactive* in nature. In a fully competitive environment, the best planning approach is *proactive* — customer needs, competitor offerings and technology availability are the driving factors behind service deployment. The key factors considered in a proactive business case include revenue generation through the introduction of new services, as well as capital requirements, OA&M savings and revenue protection of existing services.

The competitive proactive approach discussed in this paper is based on two strategic thrusts:

(1) The telephone operating company should protect and enhance its existing revenue streams by exploiting and enhancing its existing services and its installed base of access, transport and switching equipment.

(2) The telephone operating company should strategically select, enter, and win new markets. In order to be successful, the operating company may need to form partnerships or strategic alliances to obtain the required functionality to enter a new market.

### 4. NETWORK ARCHITECTURE EVOLUTION

Implementation of these two proactive thrusts will require evolution of the telephone operating company network. This section provides recommendation that allow the network to evolve to achieve these thrusts.

#### 4.1. Protect and Enhance Existing Revenues

A telephone operating company should exploit its existing strengths in telephony. The approach suggested is a phased method in which the incumbent performs a number of network modernization steps. It is likely that these actions will overlap one another in various parts of the network.

#### 1. Modernize switching base to digital

The incumbent first completes the modernization of its switching base to digital technology. For most operating companies, this step has begun, and in some cases is already complete [2]. While modernizing to digital, depreciation of digital technology should be accelerated (as compared to analog depreciation rates) to allow regular upgrades (processing, memory, service enhancements), thus ensuring that the operating company is on an equal technology footing with competitors.

#### 2. Exploit service capabilities of digital base

Once modernization has begun, the digital base can be exploited by deploying revenue-generating nodal and local area services such as centrex and voice-mail to increase the service revenue of the digital investment. This trend to rapidly market and deploy services drives a need for ongoing infrastructure investment, a factor often ignored when classical planning approaches are applied to digital technology. The infrastructure utilization due to service demands must be continuously evaluated and the technology and capital investment required to meet these demands must be expected and planned for. Thus, service provider business cases for infrastructure technology are based on a coupling of services and technology.

#### 3. Modernize the signalling network

The third step involves establishing an advanced signalling network infrastructure. Generally, modernization of the signalling network begins with the toll network, and ends with the local network. As well as reducing call-completion times and increasing network efficiency, it will also allow operating companies to begin deploying sophisticated revenue-generating services such as 800/008, calling-name delivery, and other Intelligent Network (IN) and Advanced Intelligent Network (AIN) based services throughout the network.

#### 4. Network interconnections

Incumbent networks will increasingly be required to interconnect to other networks. First, regulatory decisions will force interconnection of local or toll switches with those of competitors. As competition for other services emerges, so too will interconnection requirements to other competitors. Second, increased numbers of partnerships and alliances will drive interconnection to partner networks. These partner networks may use different technologies, thus challenging planners to provide seamless interworking (using these different technologies) from an end-user point-of-view. Finally, user demands to customize, control, and manage their own services will require interconnection to customer networks. These increased levels of interconnection will be required in both the switching and signalling networks.

#### 4.2. Enter New Markets

The second strategic thrust — to strategically select, enter, and win new markets — may also require network evolution. The evolution may include building on the existing network, building or purchasing an overlay network,



and/or unbundling the network to enable partnerships. The best alternative is governed by the market and service requirements (Fig. 3).

### Network Options for Entering New Markets

#### Option 1. Use Existing Network

Advantages: high network coverage

Issues: optimized for telephony services

#### Option 2. Deploy an Overlay Technology

Advantages: independent operating environment; enables speed to market; can use short-lived technology

Issues: limited network coverage

#### Option 3. Find Partner/Form Strategic Alliance

Advantages: potential to exploit strategic strength of partner company; partner shares risk of offering new services

Issues: profits must be shared with partner; may require interconnection of different technologies

Fig. 3. Options for entry to new markets. The best strategy is governed by the market and service requirements.

#### Option 1. Use the existing network(s)

Based on traditional planning methods, operating companies may consider deploying new services by modifying the existing network. This method is best for those services that are closely related to voice telephony, such as voice mail.

#### Option 2. Deploy overlay technology

For services that do not map easily to the existing technology base, such as data services, overlay technology may be the best alternative. Conventional wisdom states that minimizing overlay networks will reduce operations costs. However, overlay networks may be required for a number of reasons. In cases where the life of the service and its related equipment is likely to be short, there is low risk in deploying an overlay solution because equipment can be depreciated at a rate comparable with the actual life of the service. In addition, overlay networks enable rapid service deployment since there is no need to modernize an established base. However, to minimize network complexity and operations costs, overlay networks should be based on an architecture that provides intelligent modular network blocks that communicate with other network elements via standard interfaces.

#### Option 3. Establish partnership

A third option for the operating company is to partner with other service providers or network operators to share

the risk of entry. Partnerships or alliances are formed when the incumbent service provider has identified a strategically important capability that it lacks the core competency to provide (Fig. 4). With this approach the network of the operating company is unbundled, allowing partner networks to fully interconnect to the access, switching, toll and/or signalling networks of the operating company. For example, access to the company's signalling network will allow value-added service providers to offer new services such as home banking and shopping by customizing the messages displayed on a user's phone.

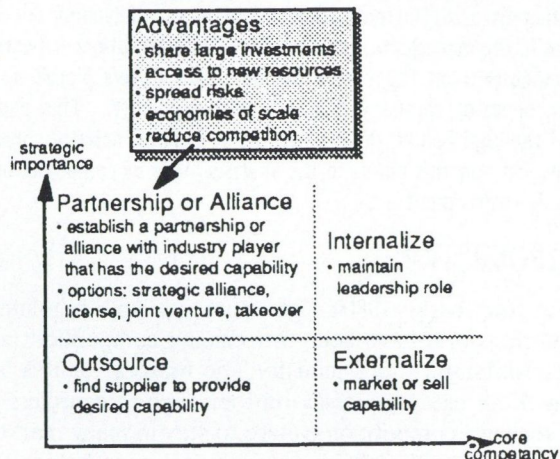

Fig. 4. Partnerships are established when a required capability is of high strategic importance and a low core competency exists

## 5. SUMMARY AND CONCLUSION

The traditional monopolistic environment of an established telephone operating company is undergoing significant change. In order to respond to emerging competition, the company must evolve its network. Two companion thrusts are recommended which allow the established service provider to take a proactive strategy in evolving its network architecture.

The first thrust, that of protecting and enhancing existing revenue streams, requires network evolution towards an architecture that supports advanced network services. This evolution occurs in phases: deploying digital switching technology to enable advanced nodal services, modernizing the signalling network to enable network-wide enhanced services, and finally planning for network interconnection to customer, partner, and competitor networks.

The second thrust involves strategically selecting, entering, and winning new markets to establish new revenue streams. Entry of new markets may involve enhancing the existing network, deploying overlay technologies, or establishing partnerships and/or strategic alliances.

## REFERENCES

[1] Competition in the Local Exchange, S. Knowler, *Telecommunications Journal*, Vol. 60-V, 1993, pp. 205-216.

[2] *Americas Public Switching Market: 1993 Edition and Asia-Pacific/Middle East Public Switching Market: 1993 Edition*; Northern Business Information.



# EMPLOYING DYNAMIC NETWORK CONTROL STRATEGIES IN A COMPETITIVE ENVIRONMENT

V. PIZZICA

TELSTRA LIMITED, AUSTRALIA  
11/171 ROMA ST BRISBANE 4000  
AUSTRALIA

This paper discusses the motivation behind the use of dynamic control schemes in the management of digital telecommunications networks. The emphasis is on the unique demands and drivers placed on a network operator company in a competitive market. This paper outlines the logic behind the deployment of dynamic network control schemes and how this differs to the analysis made by companies in a monopoly environment.

## 1. INTRODUCTION

Since the early 1980's, governments and regulators around the world have been introducing competition into the telecommunications industry. The reasons for this are worthy of an extensive essay on their own. Regardless of these reasons, competition is here to stay in many markets and is certain to be introduced in many more before the decade is out.

The introduction of competition to a market creates many interesting new challenges and drivers for the incumbent operator. These challenges go well beyond how to build a network that can interconnect with the new operator. How will pricing strategies dictate traffic flows? What will be the effect on holding times and calling rates? The list is endless.

Underlying all these questions is the most fundamental of all — how can the incumbent operator not only survive the rigours of competition, but thrive, grow and expand? The answer in virtually all cases will lie in the ability of the incumbent operator to recognise the need to become more orientated to being a service provider for its customers. This will mean setting in place the network, processes and systems, that can support excellent customer service and provide a high standard of perceived performance.

In contrast, dynamic network control strategies have existed in academic literature for years. There has however, only been limited deployment of these many schemes into real networks. Why is this so? Perhaps the answer lies in understanding what is common about the operators that have pursued these dynamic control strategies the most aggressively. Indeed, each of these operators is exposed to strong competition for network services!

This paper examines how the introduction of competition to a market influences the strategies used by operators in controlling and managing the network. The established network infrastructure of an incumbent operator is a large and valuable asset. It is also a potential handicap to competing with a new entrant that sets up a network in a green fields situation. Typically, new operators will deploy the latest technology and use simple architectures

to exploit this advantage, through adjunct systems which are loaded with functionality that give a competitive edge. Any initiative that can be taken to gain a perceivable advantage through effective control of information flows in the network needs to be pursued.

After initially describing the characteristics of a competitive market and comparing those to a monopoly market, a network control model is introduced to enable discussion around the concepts of network control. The significant competitive edge provided by dynamic control systems is then examined.

## 2. COMPETITIVE MARKET CHARACTERISTICS

The introduction of competitive carriers into a monopoly market substantially alters the traditionally understood calling patterns of customers. An increase in market volume is the most visible result, but the tremendous volatility of profile variations and dispersions are alarming.

A key disruptor to traffic profiles is "spot specials" (from any carrier) that result in peak volumes of traffic rapidly flip-flopping throughout the network to either the incumbent's Long Distance network or to the competitor's gateways. Holding times also lengthen as customers take advantage of lower prices, but holding times now become a function of the tariff period in which they occur! Customer redial behaviour now has a new dimension as calls are not abandoned when congestion or busy signals are received — instead the call may be lost to the other carrier!

Significantly, there is considerable practical evidence that when customers can get their calls through on the incumbent's network, they do not try the competitor's network. This is an important calling pattern to set in a customer's mind, as it discourages these customers from getting confidence in the other carrier's network and perceiving it to perform better than the incumbent's.

All practical evidence convincingly destroys any previous assumptions of traffic flow stationarity in the so called "busy hour". A competitive market's traffic is anything but static in all key parameters for defining that traffic flow — volume, dispersion, holding time, arrival rate.

At the same time, an operator's capital drivers require better utilization of installed plant, thus the traditional method of ensuring good performance in a monopoly market cannot be used — over provision. The time to react to changes in point to point capacity requirements also needs to be much shorter than the yearly provisioning cycle and thus more aligned with market demand.

The final and probably the most important consideration concerns call completion probability. Since call revenues



must also reduce through competition (as a result of lower prices and loss of market share), the need to maximise the call completion probability is paramount. Even the smallest fraction of a percent increase in call completions can add significantly to the revenue collected. Call

completion probability or Grade of Service are important measures of call quality and are indicators of the market's perception of the performance of the network.

In summary, the table below compares these characteristics of monopoly and competitive environment.

Table 1. Comparison of Network Characteristics in a monopoly versus those in a competitive market

Characteristic	Monopoly Environment	Competitive Environment
Holding Times	2 to 3 minutes.	3 mins in working hours. 5 to 15 mins outside.
Dispersions	Static in Busy hour. Static in off peak.	Volatile in all traffic periods.
Volume (call arrivals)	Modest growth to a set daily and diurnal profile	Volatile fluctuations dependent upon advertising strategies.
No. of Mass Calling Events	Increasing.	Very frequent, increasing.
No. of products types using Number Translation facility	Small, increasing.	Very many offered by incumbent and other carriers.
Call abandonment rate (on busy/congestion)	Typically 30 %	Much higher as calls are lost to other carriers
No. of re-attempts on busy	2 to 3.	2 to 3.
Provisioning rate	Yearly.	Needs to closely match demand.
Junction utilization rates	Say X Erlangs/Circuit.	Y Erlangs/Circuit, $X < Y$ .

### 3. NETWORK CONTROL MODEL

In order to discuss dynamic network control strategies it is necessary to define a suitable model. The flow of services and products through the various elements of a network can be represented by the diagram in Fig. 1. This diagram demonstrates the layers in which control can be exerted in the network.

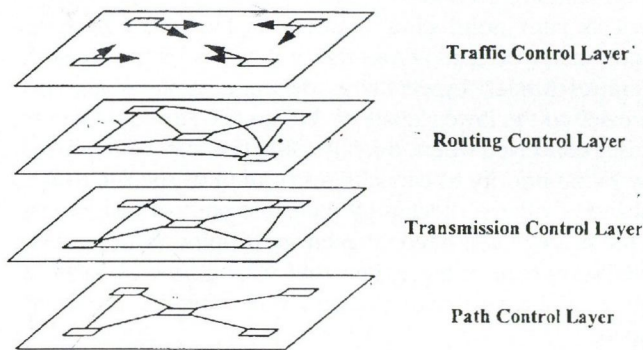

Fig. 1. Network Control Model

In the Traffic Control Layer, customers generate point to point traffic flows for individual products. The Traffic Layer can be considered as a set of point sources and sinks with only logical links existing. A type of control strategy that can be applied in the Traffic Control layers is call gapping.

In the Routing Control Layer, traffic from point sources is directed on to routes by some routing algorithm and using switches to focus and distribute the traffic. Apart from standard fixed routing schemes, there are several dynamic schemes in the academic literature and some operators have successfully deployed a selection of these. In the Transmission Path Control Layer, the routes between switches are established on transmission paths that criss-

cross the network. Path control in this layer can be manually patched or use path protection switching such as in SDH.

In the Transmission Media Control Layer, the transmission systems that carry the traffic from point to point are carried on physical media such as Optical Fibres, Copper or Radio. Switching to alternative media in the case of bearer outages can be performed manually or automatically such as by a DXC.

Clearly, control strategies can be developed for each layer, but if each layer attempts to independently optimise the carried traffic under various conditions, the result may be anything but a global optimum! Unified or at least co-ordinated control strategies are required to ensure that actions taken at each layer are made with knowledge of the impacts and available resources at each of the other layers.

### 4. SIMPLE NETWORK STRUCTURE

The management of complexity in networks requires acceptance of the fundamental need to build simple network structures. The key ingredients for commercial success in telecommunications come from price, features, time to market and customer service. The delivery of high quality customer service in a cost effective manner can only occur if the structure of the underlying network that is delivering the features to customers is simple and therefore easily modelled. Similarly, fast delivery of features with enhanced functionality is easily achieved through a simple Network structure.

A good model for such a structure is the Two Layer Architecture shown in Fig. 2. In this model, the lower layer provides access to the network for customers, so the switches of this layer are rich in features and functionality. In the upper layer, end to end connectivity for a national network is provided by a small collection of large,



customer-less tandem switches.

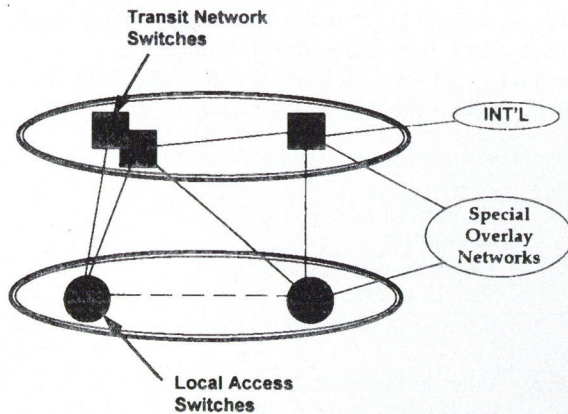

Fig. 2. Simple Two Layer Architecture for modern telecommunications networks

This model is not a new revelation in architectural design, but it is surprising how quickly this simple structure can become distorted unless a conscious decision is made to maintain simplicity. Naturally, this architecture is most suitable for all digital networks and is thus the type of network in which a dynamic control scheme is likely to be applied.

## 5. ADVANTAGES OF DYNAMIC NETWORK CONTROL SYSTEMS

The business drivers for development of a network in a competitive environment can be described as follows:

1. Customers must perceive high quality in network based products.
2. Utilization of installed plant (capital) must be high.
3. The network must exist in an environment which is rapidly changing in all important parameters.
4. The network must be inexpensive to manage and operate.
5. The network must be inexpensive to plan and build.

The two important physical network characteristics that summarise this list are circuit utilization efficiency and call completion probability. When a network is thrust into a competitive environment, the only possible way of improving these two characteristics is through a dynamic network control system! Typically, state dependent dynamic control algorithms attempt a maximum flow optimisation of calls arriving into the network and are more effective than time dependent systems, (although this latter type is often a good first step along the path to dynamic control implementation). State dependent dynamic control systems are best able to manage traffic flow and routing so that maximum possible performance is obtained.

Traditional control schemes, using manual methods of updating the network, rely on fixed routing strategies that have been calculated under some assumption of stationarity, and thus, cannot possibly react fast enough in a dynamic environment.

Indeed the only control scheme that can cope with such an environment is one which can execute control actions in a time scale that is shorter than (or at least comparable to) the time constants for change in the network. Even

the best manual system relies on telemetry, about the network status which is at best 3 to 5 minutes old, and this is well outside the time frame to prevent degradation of performance given the volatility of network traffic flow.

Dynamic control schemes affecting the Traffic and Routing layers of the Network Control Model must therefore exert control in a time frame of the order of every 5 to 20 seconds. Furthermore, there is considerable theoretical and practical evidence to support execution of these control actions from a centralized processing centre that models the flow of traffic and status of the network so that it is best able to obtain a global optimum.

Centralized control systems operating in short update cycles to provide the most optimal call completion probabilities. Provided a physical implementation of such a scheme can be practically deployed, they are thus highly desirable for a network operator. Feedback from successfully deployed systems indicates improvements in grade of service from 1 % to 0.01 % at the same time as circuits have been reduced by more than 5%.

The added benefit of a dynamic control system is its ability to cope with instances of stress associated with the failure of key network infrastructure. The same algorithms that optimise total network flow under normal conditions continue to operate when substantial capacity reductions occur. Control actions in the lower two layers of the Network Control Model will work to restore this capacity, but the time scales of controls in this layer are typically longer than those in the top two layers. Thus, whilst the Transmission and Path control algorithms (be they manual or automatic) are busy restoring capacity over a time scale of minutes or hours, calls are being rerouted or gapped, in time scales of seconds or less.

This latter point does however highlight the need for coordinated control across the four layers of the Network Control Model, especially as dynamic methods are progressed to the lower layers of the model. Situations can be easily conceived where overall traffic flow can be improved, by giving priority to capacity restoration of specific routes, ahead of others affected by the same path or system loss. This strategy will become even more important, as ATM admission control algorithms that manage the capacity required for a particular point to point demand are developed.

The deployment of a centralized dynamic control system, can also lead to improvements in the expense required to manage, operate and plan the network overall. Apart from automating the application of controls to the network, and therefore cutting direct manipulative costs in Network Management; the opportunity exists to use artificial intelligence to interpret the wealth of network status data passing through the centralized system, and thus determine provisioning requirements across the network.

In other words, on a daily basis, it becomes possible to have the network tell the operator the best way to configure the network and where the next group of circuits should be added! Significant planning expenses can be greatly reduced by simple processing systems linked with a dynamic control system. Operational savings are also obtained, by integrating the control system with other network management and operations systems, so that the



common use of the telemetry on network status, facilitates improvements in a range of other operational processes.

There are other opportunities presented by centralized dynamic control systems. It becomes possible to link the control algorithm with a measure of service priority to ensure higher revenue traffic flows have a better standard of performance. This is an important edge to have when large business customers are affected by deep discount traffic surges that result from mass marketing activity. It is possible to extend this principle and link the centralized control system with service databases, and thus apply network controls in a manner appropriate to the type of product being carried and its network wide demand.

Lastly, it is important to emphasise the ability to extend these results to ATM call admission and routing control. It is self-evident that ATM will require similar dynamic control systems to the types outlined in this paper. Whilst there is considerable work underway to utilise decentralized control algorithms, practical experience in competitive networks is demonstrating the real benefits of centralized control for achieving a global network optimum.

Regardless of development of dynamic control in tomorrow's ATM networks, there are many good reasons to deploy dynamic control in the circuit switched networks of

today!

## 6. CONCLUSIONS

It has been shown that the deployment of network structures utilising dynamic control schemes are an essential requirement for telecommunications service providers of the 1990s. When one considers how long dynamic control has been debated in the telecommunications industry, it is noteworthy that it has only been the introduction of competition that has driven network operators in search of every last drop of performance from the capital spent on network infrastructure. Dynamic network control has come of age and is now a prerequisite for a network being operated under strong competitive pressure.

Dynamic control systems of varying functionality are in use in many networks today. Generally the most successful systems have proven to be centralized in some way. The use of centralized systems opens up many other opportunities for expense reduction and enhanced functionality delivered to customers.

Perhaps in a few years, the world will look back on the days before dynamic control systems existed and wonder how we possibly got by!

## REFERENCES

- [1] R. Gibbens and F. F. Kelly: "Dynamic Routing in Fully Connected Networks", *IMA Journal of Mathematical Control and Information*, 1990.
- [2] D. Mitra and J. Seery: "Comparative Evaluations of Randomized and Dynamic Routing Strategies for Circuit Switched Networks", *IEEE Transactions on Communications*, Vol. 39, No. 2, Januar 1991.
- [3] M. de Miguel Pioro and M. I. Pita: "Telecom Networks Evolution Towards Secure Dynamic Structures", in *ITC Specialists Seminar*, Cracow, April 1991.
- [4] V. Pizzica: "Dynamic Alternate Routing in the London Metropolitan Telephony Network", MSc Project Dissertation, University of Essex, 1992.



# NETWORK PLANNING SYSTEM

K. MASE

NTT TELECOMMUNICATION NETWORKS LABORATORIES  
9-11, MIDOR-CHO 3-CHOME  
MUSASHINO-SHI, TOKYO, 180 JAPAN

Network restructuring becomes indispensable from time to time to realize high performance under a changing environment. An advanced network planning system called PLANET is under development in Nippon Telegraph and Telephone Corporation (NTT) to support the studies required for network restructuring. This paper describes the concepts and key techniques of PLANET.

## 1. INTRODUCTION

The nation-wide telecommunication network continues to grow to serve more customers and provide more services. As a result, the present network is very large and complicated. Various changes may affect networks. Traffic flow patterns change significantly, especially in a competitive market. Operation cost is increasing relative to facility cost. New transmission and switching facilities are being introduced and new telecommunication services are being planned. This changing environment necessitates occasional network restructuring to realize high performance. An advanced network planning system called PLANET is under development by the Nippon Telegraph and Telephone Corporation (NTT) to support the studies required for network restructuring. This paper describes the concepts and key techniques of PLANET.

## 2. CONCEPTS FOR PLANET

### 2.1. Integration of long-term and short-term planning capabilities

Conventional and proposed approaches in network planning systems are shown in Fig. 1. The problems with conventional network planning systems are summarized below.

- Long-term and short-term network planning systems are independent of each other.
- Long-term network planning systems deal with only simple networks.
- Short-term network planning systems deal with only the existing network structures.

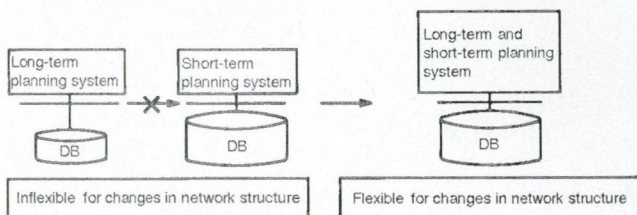

Fig. 1. Approach to network planning and design

As a result, the conventional network planning approach seems inflexible to changes in network structure.

The guidelines for PLANET are summarized below.

- The long-term and short-term network planning systems are integrated.
- The long-term network planning system can deal with the complexity of existing networks.
- The short-term network planning system can deal with a restructured network.
- The proposed network planning approach is flexible with respect to changes in network structure (Fig. 1). A similar approach has been proposed in (1) to (2).

### 2.2. Responsibilities of the network planner and role of the support system

Optimization techniques have been widely used in dealing with network design problems. Design problems of circuit networks, path networks and transmission media networks are usually treated independently in the formulation of optimization problems. The parameters in one layer, however, may depend on those in other layers. Thus, this approach may not guarantee overall optimization. Another problem is optimization is based on a single parameter, that is, facility cost. While it is difficult to deal with multiple evaluation factors in conventional optimization approaches, network structure must be evaluated in terms of multiple factors, such as facility cost, operation cost, and the number of nodes and links.

In our approach, the network planner is responsible for choosing a set of candidates for the network structure. PLANET is responsible for evaluating the candidates from various points of view. It is the responsibility of the network planner to select one of the candidates as the solution on the basis of evaluation results produced by PLANET. This approach can deal with the overall aspect of networks, including circuit, path and transmission media networks without the excessive simplification, used in conventional optimization approaches. It can also consider multiple evaluation factors since the network planner is responsible for selecting the final solution. A similar approach has been proposed in (3) to (6).

### 2.3. Function segmentation

A function block diagram for PLANET is shown in Fig. 2. The interface between blocks is defined in a general form. The function of each block can be modified without changing the interface. Thus, PLANET is flexible for function enhancement and modification.

### 2.4. Network representation using network components

The structure of a nation-wide telecommunication network is not always uniform. Various structures may appear in the network, depending on conditions such as regional characteristics. An efficient network representa-



tion method is thus required. Overall network structure is represented as a combination of network components in PLANET. The network planner uses a graphical user interface to choose network components and rules for connecting them to each other. Thus, he can easily create a heterogeneous network structure within PLANET.

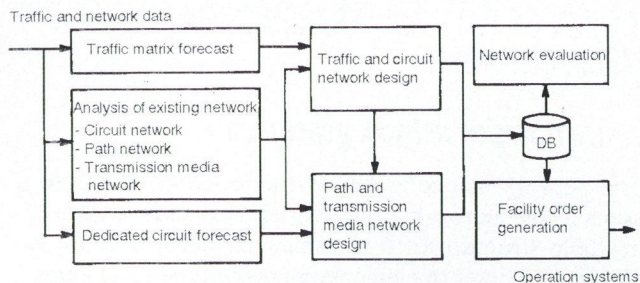

Fig. 2. Segmentation of network planning functions

### 3. DESIGN OF SWITCHED NETWORK

#### 3.1. Design method

Two views are introduced for switched networks: traffic network and circuit network (Fig. 3). A traffic network is macroscopic view of switched network. It is composed of traffic nodes and traffic links. A circuit network is a detailed view of a switched network. It is composed of switches and trunk groups. The design of a switched network has two stages, traffic network design and circuit network design (Fig. 4). The initial numbers of switches for traffic nodes are obtained from the result of traffic network design. The final numbers of switches for traffic nodes and the sizes of trunk groups are obtained as the result of circuit network design. This two-stage design process reduces design complexity.

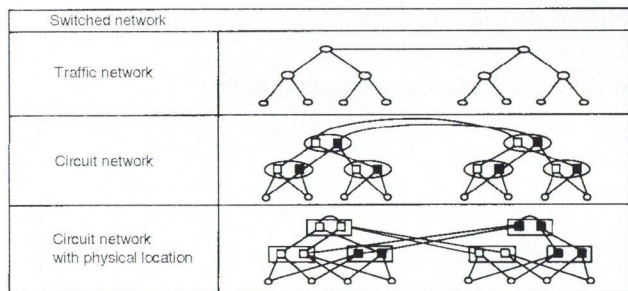

Fig. 3. Hierarchical views of switched network

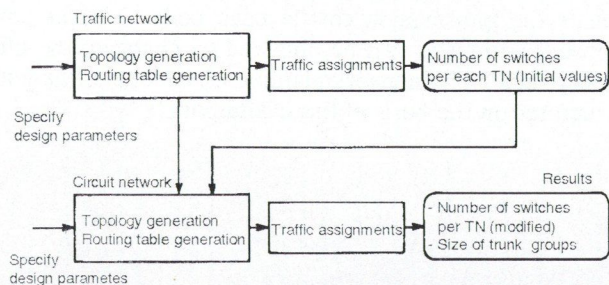

Fig. 4. Traffic and circuit network design flow

#### 3.2. Traffic network model

A network is defined as a set of subnetworks, which are parts of network administered as a unit (Fig. 5). For example, each subnetwork may correspond to an individual carrier. A subnetwork is defined for a corresponding area, that is, a set of local switches. Subnetworks may be defined in the form of an overlay. That is, a subnetwork may be defined in small area that is included in another area. Traffic between a pair of local switches is carried by the subnetwork that corresponds to the smallest area including both switches. Two subnetworks, each covering a different area, may be connected to each other by setting up a connection link between their traffic nodes. The network planner is responsible for setting up these connection links.

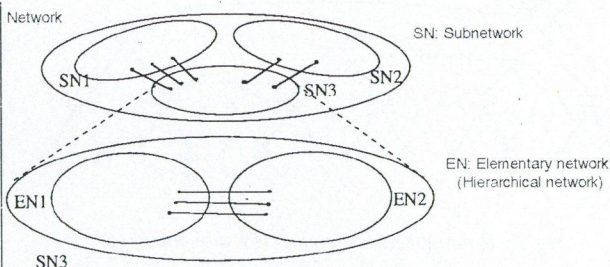

Fig. 5. Traffic network model

A subnetwork is defined as a set of elementary networks. An elementary network has a uniform network structure in terms of topology and routing. Examples of elementary networks include hierarchical networks, originating and terminating tandem networks, and mesh networks. Elementary networks can be generated with a relatively small number of parameters specified by the network planner, since their topologies are uniform. Elementary networks may be connected to each other by the same rules as for connecting subnetworks. Thus, the network planner can generate various subnetwork structures in a building-block manner by combining elementary networks. Examples of network structures are shown in Figs. 6-1, 6-2, 6-3.

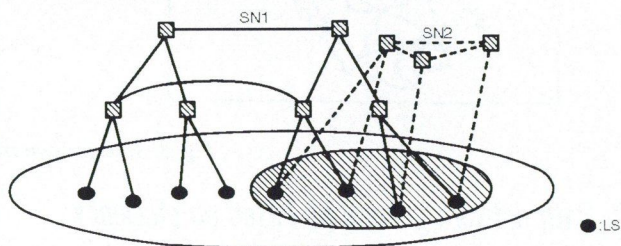

Fig. 6-1. Subnetwork structure (Type 1)

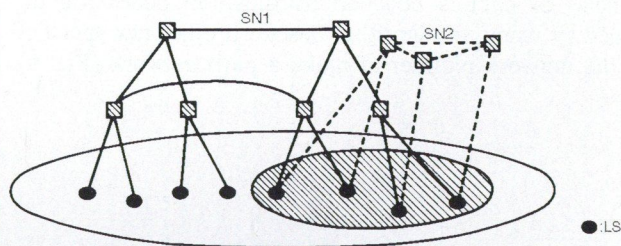

Fig. 6-2. Subnetwork structure (Type 2)



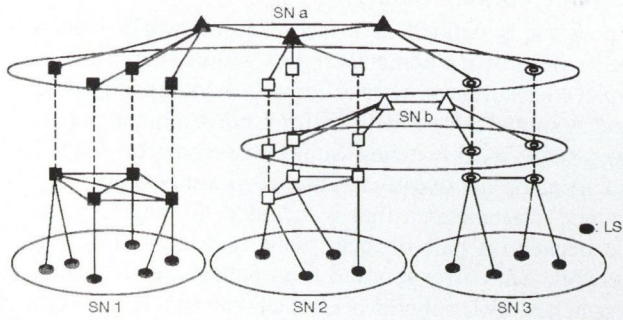

Fig. 6-3. Subnetwork structure (Type 3)

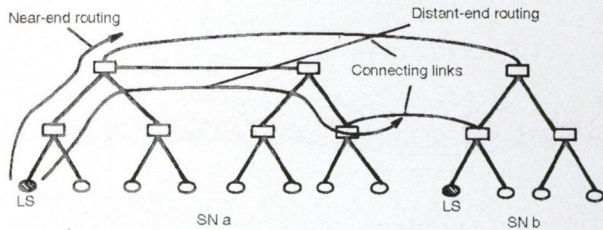

Fig. 7. Routing between connected subnetworks

Two types of routing are available for connected subnetworks, near-end routing and distant-end routing (Fig. 7). Near-end routing makes calls reach the destination subnetwork as soon as possible; distant-end routing makes calls arrive as late as possible.

## 4. DESIGN OF PATH AND TRANSMISSION MEDIA NETWORKS

### 4.1. Transmission network generation

The network planner specifies the topology of a transmission media network using a graphical user interface. The whole structure of a transmission media network is represented as a set of elementary networks, such as loops, lines, and meshes. Elementary network, may be connected to each other. The whole network may have a hierarchical structure (Fig. 8). Circuit routing is automatically determined for each end-to-end circuit demand according to rules specified by the network planner, such as shortest path routing and route diversity.

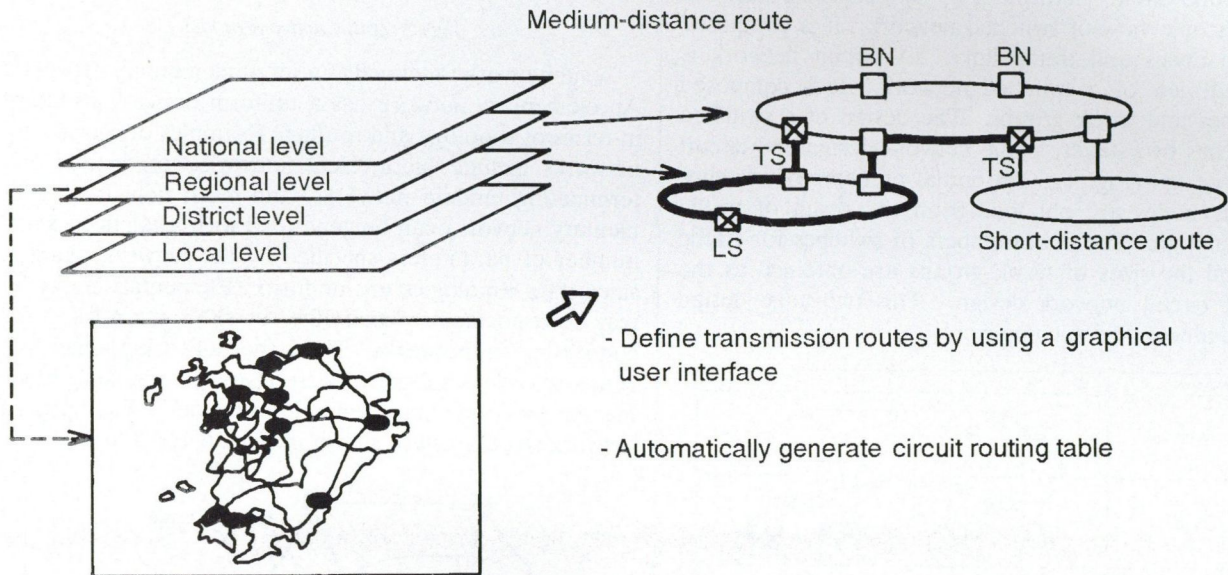

- Define transmission routes by using a graphical user interface
- Automatically generate circuit routing table

Fig. 8. Transmission media network generation

### 4.2. Path network generation based on efficiency

End-to-end circuit demands are mapped onto the transmission media network according to a circuit routing table. Bundles of circuits between transmission nodes are designed by using an algorithm based on efficiency specified by the network planner to make a path network (Fig. 9).

Transmission node equipment is then selected according to the path network structure. This result is used to estimate the transmission cost at each node. Various path network structures can be obtained by changing the efficiency value. The network planner selects one of the path structures on the basis of this evaluation.







# APPROACHES TO SDH NETWORK DESIGN

N. SEEL and A. WRIGHT

BNR EUROPE  
LONDON ROAD, HARLOW, ESSEX, CM179NA  
UNITED KINGDOM

This paper discusses the structure of local and national telecommunications networks based upon SDH. The nature of PSTN and private circuit traffic is analyzed to derive options for the local network structure. The national network is then considered as providing an interconnect service between local networks. The conclusions emphasize the value of end-to-end path management and protection, and the structured use of add-dop multiplexers and digital cross-connects to optimize network flexibility and network equipment utilization.

## 1. INTRODUCTION

The hierarchical structure of the transmission network was traditionally driven by the requirement to support a switching hierarchy of local, regional and national trunk switches. The network evolved organically, with architectures retrospectively being developed, to analyze what is fact had been achieved [4].

With the introduction of SDH, especially in a context where digitalization has led to a simplification and rescaling of the switch hierarchy, it is appropriate to reconsider transmission network architectures.

This paper takes the view of SDH network architecture outlined in [2] as a starting point, and introduces a number of further options for network design. We start from the customers, by considering the function — and consequent design alternatives for — the local network. We then consider, in a similar manner, the national network, which has the local network as a customer.

The traditional function of the local network has been to collect traffic, route local traffic to adjacent customers and consolidate more distant traffic to gateway to the national network (Fig. 1).

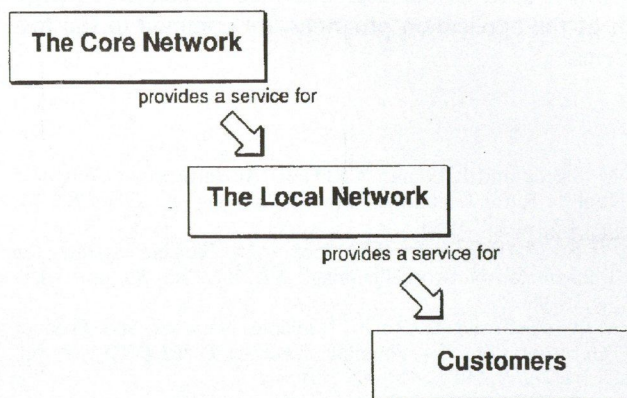

Fig. 1. A Service Hierarchy

Historically the link from the customers to the local exchange has been at VF (analogue) or 64 kbps. However, with the introduction of remote concentrators for switched services, 2 Mbps has been pushed closer to the customer premises. With SDH it has become expedient to position

STM-1 multiplexers closer to the customer, so that access comes to be *everything up to the STM-1 mux* (in some cases, the STM-1 mux itself is CPE or CLE, however).

A contemporary view of the proposed structure of SDH networks [2] describes three tiers: Tier-3 is from the customer to the first major flexibility point; digital local exchange (DLE) or digital cross connect (DXC). Tier-2 is the regional interconnect of Tier-3 systems and Tier-1 is the national core network.

While Tier-3 and Tier-1 have relatively well-defined characteristics in terms of the nature of the traffic acquisition and routing task they accomplish, it is possible that the existence of a separate Tier-2 network organization will become less evident in the future. This mirrors a similar simplification in the switching hierarchy as DLE's become larger (Fig. 2).

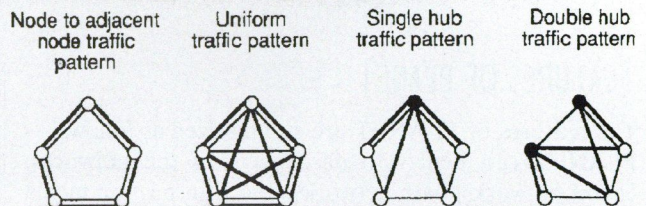

Fig. 2. Some Traffic Patterns

We will look first of all at the structure of local/urban networks (Tier-3/Tier-2), and then generate the requirements and consequent structural options for the core network, at Tier-1.

## 2. THE LOCAL NETWORK

We shall consider the PSTN traffic and private circuit traffic separately in the first instance.

### 2.1. Carrying local PSTN traffic

The simplest local switch arrangement is to hub all the handsets, via copper VF or ISDN BRA links to the switch. Where loop lengths are long, and as fibre costs become more competitive, multiplexers functioning as remote concentrators, or remote switching units can be placed between the customers and the switch. In this evolution the switch becomes larger, terminating more traffic, and providing economies of scale and management. Some options are shown in Fig. 3.

In (A) we see a digital local exchange switch (DLE) hosting remote concentrators; in (B) these concentrators are interconnected to their local exchange via STM-1 multiplexers on an STM-1 ring; in (C), we see remote switching units linked to an STM-1 ring, and hosting off a large DLE. In each case, the central DLE has links with



other DLE's and the national network.

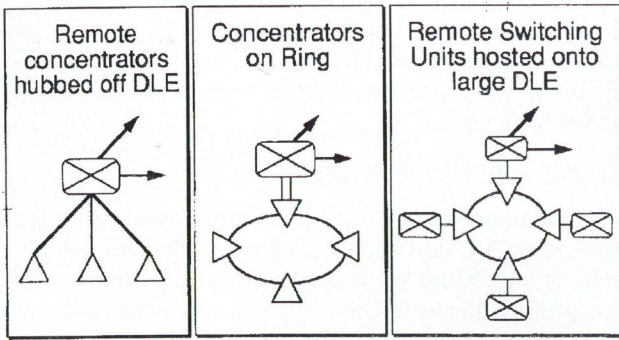

Fig. 3. Local Network: PSTN Traffic

## 2.2. Private Circuit traffic

As with PSTN local traffic, Private Circuit (PC) traffic is a superposition of uniform traffic and hubbed traffic.

It would be traditional to assign direct point-to-point links where the traffic level demanded it, and convey other traffic to a flexibility point for consolidation and grooming<sup>1</sup>. For many local networks, however, the granularity of STM-1 is so large that high fill is rarely seen. Additionally, given business churn, this solution is too inflexible. This leads to the conclusion that a local cross-connect functionality is required both to consolidate and groom, and to provide a central point for managing traffic, and in particular *churn*.

This can be achieved is by acquiring customer traffic (typically at 2 Mbps) onto primary STM-1 muxes, and then hubbing these off a 4/1 DXC. See Fig. 4a (which includes a PON).

The DXC handles inter-tributary switching between VC12's terminating onto any particular mux, switches VC12s between muxes, and, consolidates and grooms traffic to other CXC's in the same tier, and to the national network. It also permits traffic to be managed at the cross-connect point, and, provided ports and core have been preprovisioned, allows new services to be brought on-stream via software (using the subnetwork controller).

In this *centralized bandwidth management* approach, the muxes are terminals, really just STM-1 line systems (a PON is also a possibility as shown).

There are three main problems with this approach. Firstly, the fill on most of the STM-1 systems is likely to be very poor; secondly, because of poor fill, the DXC is significantly over-provisioned at the VC12 switch core; and thirdly, protection is not inherent in the architecture: replicating everything just makes it more complicated.

These points have led to architectures which distribute some of the bandwidth management into the muxes, with ring architectures as in Fig. 4b.

<sup>1</sup> Consolidation is when traffic on many, lightly-loaded links is reorganized onto fewer, more heavily-loaded links to increase system fill, and therefore equipment utilization. Grooming is when incoming traffic, which per link is destined for a variety of destinations, is reorganized so that traffic for particular destinations is routed onto links allocated to that destination.

Hubbed off digital cross-connect - notice PON

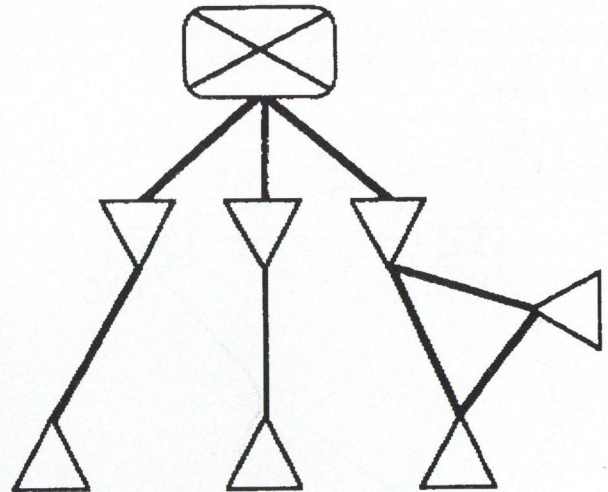

4a

Ring with 'matched nodes'

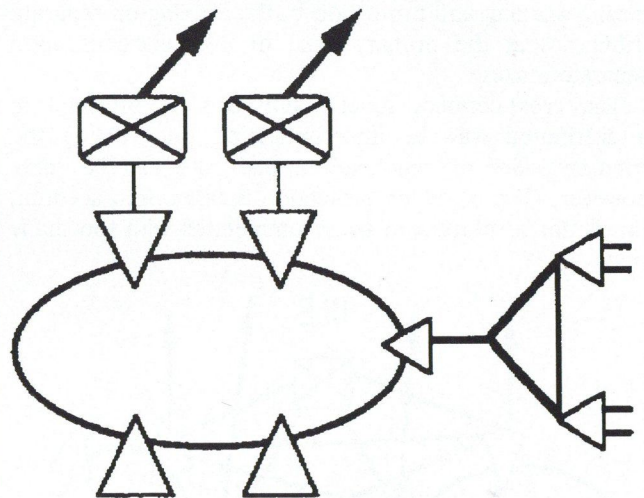

4b

Fig. 4. Local Network: Private Circuit Traffic

Here the ring is handling inter-tributary and inter-mux traffic. The DSC's are handling consolidation/grooming to the rest of the network. In the case of multiple rings, the DXC's will be connected to all of them, and will handle the inter-ring traffic as well.

This improves matters because the ring becomes a shared transmission resource, and hence fill can be made efficient. Because of the ring connectivity, path protection is easy to organize and the DXC is now getting only relevant traffic.

Traffic which is local may need to be routed via both DXC's, treating them as pass-through ring nodes. This is



a waste of DCX core but can be justified by the extra flexibility it provides in case of churn.

### 2.3. Combining PSTN and PC traffic

There are various ways this could be done, using either rings or chain configurations for high-fill. Fig. 5 shows a possible solution.

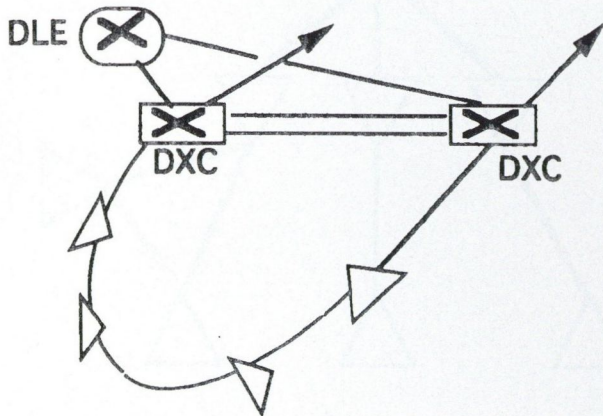

Fig. 5.

An operator may well decide to protect all PC traffic by diversely routing working and protection copies of each VC12 across the network. The working/protection switch should occur as early as possible, to the point of having working and protection traffic arriving on separate tributaries at the primary mux, or even incident upon separate muxes.

The cross-connect functionality can be provided in a distributed way by interconnecting (at STM-1) the tributary sides of ring-head muxes. As can be seen, however, (Fig. 6), when protection is taken into account, this is not a solution to be recommended with too many rings.

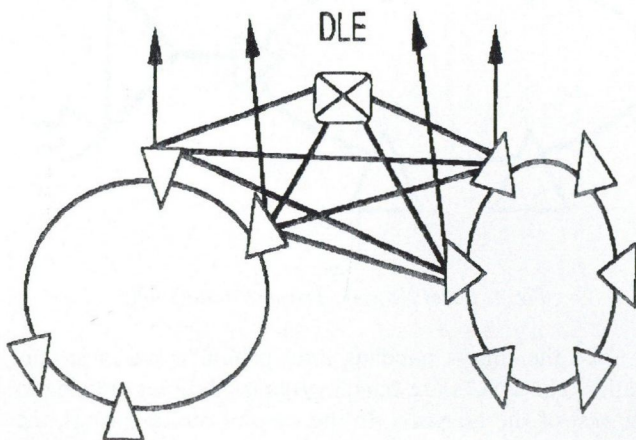

Fig. 6. Ring-interconnect in the Local Network

Each ring-head mux has to interconnect to the national gateway, the local exchange, and to each of the (duplicated) ring-head nodes on the other rings. For two rings this is 4 tributaries; for three rings 6.

## 3. THE CENTRAL PART OF THE NETWORK

In the same way that the local network provides an interconnect service for local customers (PSTN and PC), the core network provides an interconnect service for the multiple local networks.

### 3.1. The core PSTN network

This is comprized of a number of large transit exchanges which collect PCM30's from the local exchanges, and dynamically switch the voice channels onto 2 Mbps trunks destined for other trunk exchanges across the core network. In transport terms, the originate a (typically uniform) distribution of VC12 traffic between the trunk switch nodes of the core network (Fig. 7).

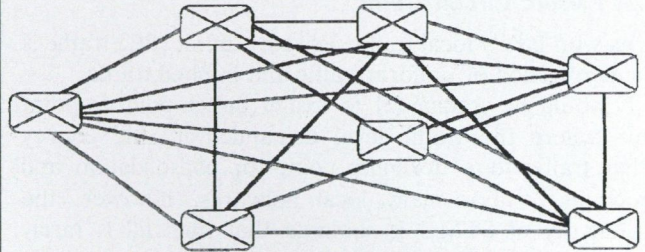

Fig. 7. The Core Network

Characteristics of the traffic are that it is typically of stable distribution, and that while multiple connectivity paths must be provided between any two nodes, it is not necessarily the case that all VC12's must be protected (although this should be an option).

#### 3.1.1. PSTN Routing

The trunk switch will reorganize 64 kbps time slots into 2 Mbps PCM30 streams targeted at particular destination trunk switches. These streams will be mapped into VC12's, which will need to be processed by a 4/1 DXC to assemble them into VC4's which will transit the core network. So we are in the domain of VC4 routing once we leave the 4/1 cross-connect on the core network side (see Fig. 8).

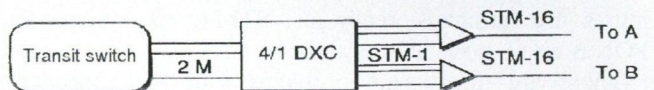

Fig. 8. PSTN Traffic

#### 3.2. PC traffic

The local DXC's in cities and regions send VC12's to other cities and regions. But they also send traffic at 34 Mbps and 140 Mbps (VC3/VC4) for services such as frame relay, SMDS and TV distribution (Fig. 9).

This requires a 4/3/1 DCX to groom this mixed payload traffic into VC4's for routing across the core network. As before, once we are on the core network side of the 4/3/1 DCX, we are in the domain of VC4 routing.



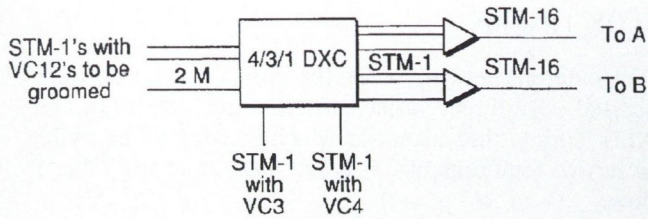

Fig. 9. PC Traffic

### 3.3. The architecture of the core network

In principle there are three basic architectures which could be used for the core network: mesh, ring or star. In analyzing these three architectural candidates, we need to consider efficiency, protection, flexibility, management, and cost.

#### 3.3.1. Mesh

A partial mesh connects the 4/1 DXC's at the local core network interface by direct links (Fig. 10 below). The links which are necessary to provide connectivity may not be justified by fill, so utilization may be too low. Where a VC4 transits a 4/1 DXC, that cross-connect will need 4/4 capability to avoid needless and expensive decomposition of the transiting payload into its lower-order constituents.

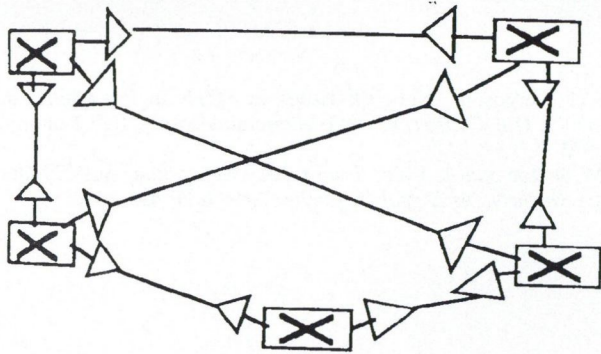

Fig. 10.

Protection is not inherent in the architecture, and for automatic protection switching (APS), 1+1 diversely-routed links will have to be deployed with impact on the cost.

Due to the preponderance of physically direct links, this is not a very flexible architecture. To add a node involves a number of extra fibre links and line systems being installed, which incurs high marginal costs for network changes.

#### 3.3.2. Rings

A ring connects the 4/1 DXC's via an STM-16 ring (Fig. 11). An alternative is to use the cross-connects as ring-nodes in their own right, as in [1].

The ring provides a linear shared transmission resource. As the number of nodes increases, the fill can approach the ring capacity to a planned degree, hence using equipment at high efficiency.

Since traffic may travel both ways around the ring, automatic protection switching can easily be managed for VC4 path protection at the level of the ring. Alternatively, section protection may be employed, via the Shared

Protection Ring mechanism.

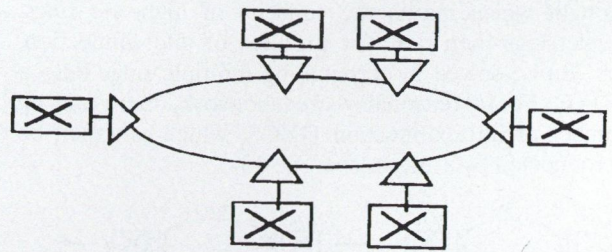

Fig. 11.

In general terms, an STM-16 ring is equivalent to a protected distributed cross-connect of 16 STM-1's capacity — i.e. a small cross-connect — although with potential for blocking, as the number of ports/nodes increases. Because of this cross-connect functionality, a properly-dimensioned STM-16 ring is a very flexible mechanism for distributing VC4's amongst its nodes.

While the ring is below capacity, extra ring nodes can be added relatively easily (sing the protection mechanisms for in-service insertion). Upon ring exhaust, new systems can be added, provided these can be cross-connected.

#### 3.3.3. Star

A star configuration homes the 4/1 DXC's onto transit 4/4 DXC's, which do the routing (Fig. 12).

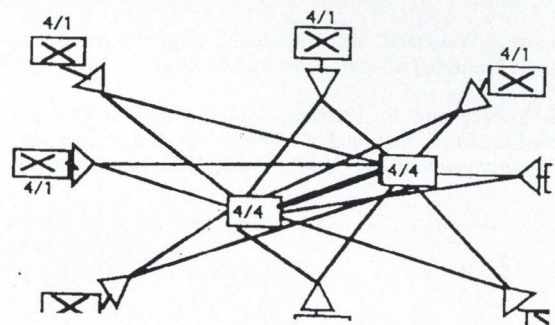

Fig. 12.

To connect any two 4/1 DXC's, it is necessary to transit a 4/4. This requires backhauling, which in general will not be so efficient as more local connectivity. On the other hand, this is potentially a very flexible architecture, if the line systems and DXC's are adequately provisioned. To bring a new office on line, simply connect it to the transit DXC's, and traffic can then be switched to other nodes as required. The result is a very manageable network, since all connectivity is handled via the central 4/4 DXC's, which can be controlled by the operations systems at these sites.

#### 3.3.4. A combination of rings + meshed central 4/4 DXC's is better

Comparing these three 'pure' architectures, it is clear that for uniform traffic distributions where traffic can be handled on an STM-16 ring, the ring solution is better. The ring provides a good combination of efficiency and flexibility, as well as constituting a higher-order unit of management.



For larger networks, communities of interest should be sought which match the capacity of high-rate rings. Multiple rings then raise the problem of interconnection, which can be solved by terminating multiple rings onto a 4/4 DXC. For a reasonably-sized network, there will be a number of interconnection DXC's, which can then be interconnected by a mesh (see Fig. 13).

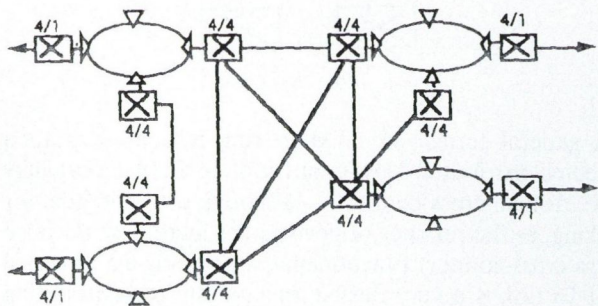

Fig. 13.

The 4/4 DXC's in the interior of the network can be used to reconfigure the network for secular load balancing, network maintenance and expansion, and for longer-term disaster recovery.

## REFERENCES

- [1] Bellcore: Wideband and Broadband Digital Cross-Connect Systems Generic Criteria. *Technical Advisory TA-NWT-000233*, 1992.
- [2] P. S. Cherng and R. Fletcher: SDH Rings for Distributed Cross-Connect Functionality. *Proc. 4th IEE Conference on Telecommunications*, pp. 109-114. The IEE, London, 1993.

## 4. CONCLUSIONS

For different network levels the possible solutions were discussed. The great variety of structures offered by the DXC's helps to find a solution which is fitting to the traffic and service requirements. It is summarized in the Table 1 below.

Table 1. Comparison

	Mesh	Ring	Star
Efficiency	Fill too low	Good at ring granularity	Too much backhauling
Protection	Extra	Good	Good
Flexibility	Bad	Good up to ring granularity	Good
Management	Spaghetti	Good	Good
Cost	Expensive	Good	Wasteful of 4/4 DXC's

## 5. ACKNOWLEDGEMENTS

Our thanks to Phil Davidson, Roy Mauger and Steve Foster in BNR, for contributing many of the ideas here, and for critiquing earlier versions.

- [3] S. P. Ferguson: Network Issues in SDH. In *Proceedings of the 4th IEE Conference on Telecommunications*, IEE London, 1993.
- [4] M. Sexton and A. Reid: *Transmission Networking: SONET and the Synchronous Digital Hierarchy*. Artech House, 1992.



# NETWORK STRATEGIC PLANNING SUPPORT SYSTEM FOR TELECOMMUNICATIONS INFRASTRUCTURE USING GEOGRAPHICAL INFORMATION

G. KIMURA, H. KATO, M. INOUE and T. UEDA

NETWORK PLANNING AND OPERATIONS RESEARCH GROUP  
NTT TELECOMMUNICATION NETWORKS LABORATORIES  
3-9-11, MIDORI-CHO, MUSASHINO-SHI, TOKYO 180, JAPAN

For the efficient construction of digital networks, a clear vision of future facilities is needed. This is called the facility grand design concept. In an effort to achieve this vision, this paper introduces a new network strategic planning support system for telecommunications facilities that uses geographical information. This system presents a great deal of information visually on maps and provides a method of planning telecommunications network infrastructures under the uncertainty of future demand and technology, and the diversification of customer services. It can support mid-term and long-term planning for the efficient construction of digital networks.

## 1. INTRODUCTION

Since the construction of improved telecommunications infrastructure in the 21st century will require a huge investment and long construction time, infrastructure planning is becoming an increasingly important activity. Heavy investment in the construction of future networks carries great risks because of uncertainties in service demands and the development of optical techniques required to implement these networks. Furthermore, labor costs are expected to rise sharply in comparison with facility costs in the future, so it is important to lower labor costs by reducing the amount of manpower required. This paper proposes a new strategic network planning support system for telecommunications facilities suitable for use under the uncertainty of future demand and technology, and the diversification of customer services. First, we classify telecommunications facilities according to their life cycle and cost structure. Then, we propose a new network-infrastructure planning system that uses geographical information. Geographical information about roads, bridges, railways, and area development plans is needed to efficiently plan telecommunications infrastructures. Some examples of planning with the proposed system are presented.

## 2. GRAND DESIGN CONCEPT

NTT has proposed the facility grand design concept [1]. It is explained in some detail below.

### 2.1. Problems in previous planning

NTT is currently digitizing telecommunications networks. Having a method of constructing facilities and maintaining high reliability is essential. To follow through with the grand design concept, it is critical that we under-

stand the changes in social and technical conditions affecting networks. Recently, there have been some important changes in these conditions:

- (1) greater diversity and shorter life-cycle in switching and transmission systems for various network services;
- (2) longer transmission distance and cable cost reductions with the use of optical fiber cables;
- (3) changes in traffic relations due to the extended range of human activity;
- (4) higher personnel expenses than material costs;
- (5) increasing regulation of underground facilities construction due to conflicts with subways and other underground facilities.

Due to these changes, a method of designing physical networks consisting of optical fiber cables is more important than one for logical networks.

### 2.2. Facility classification

Telecommunications facilities can be classified into three types according to their life-cycle and cost structure. This classification is shown in Table 1. It is important to establish a way to construct the network infrastructure using underground facilities and optical fiber cables that takes these classifications and environment changes into account. In Fig. 1 it can be seen how these facilities are built in the network planning method.

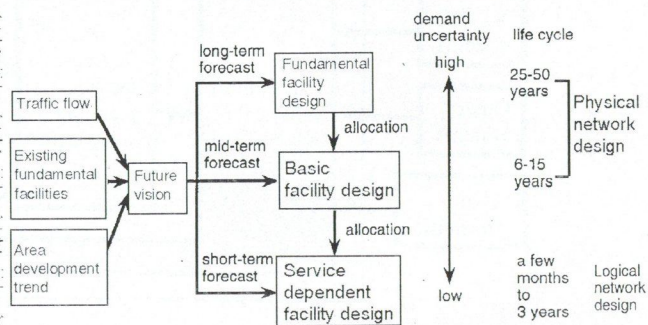

Fig. 1. Network planning method

### 2.3. Optical fiber cable networks

According to the grand design concept, optical fiber cable networks are layered for transmission routes, as shown in Fig. 1.

The cable networks in each layer form loops. Connections to a higher layered network are made through two



connection nodes to improve reliability. Traffic flowing from a source to a destination within an area is carried by only the facilities within that area. This area is determined by the amount of traffic between telephone offices, city development trends and zoning plans, and existing facility maximization. Each new local transit area is equivalent to three or four areas in traditional analog networks. Furthermore, new trunk node locations will be chosen such that there is a major building for the switching systems at the intersection of transmission routes, sufficient prospective office capacity some amount of undeveloped land nearby, and the required number of cables available in the building.

Table 1. Facility classification

Facility type	Life cycle	Cost	Category
Fundamental	25-50 years	Mainly fixed construction costs	Building, underground conduits
Basic	6-15 years	Fixed costs plus variable costs	Optical fibers, switches
Service-dependent	a few months — several years	Mainly variable costs	Logical circuits, paths

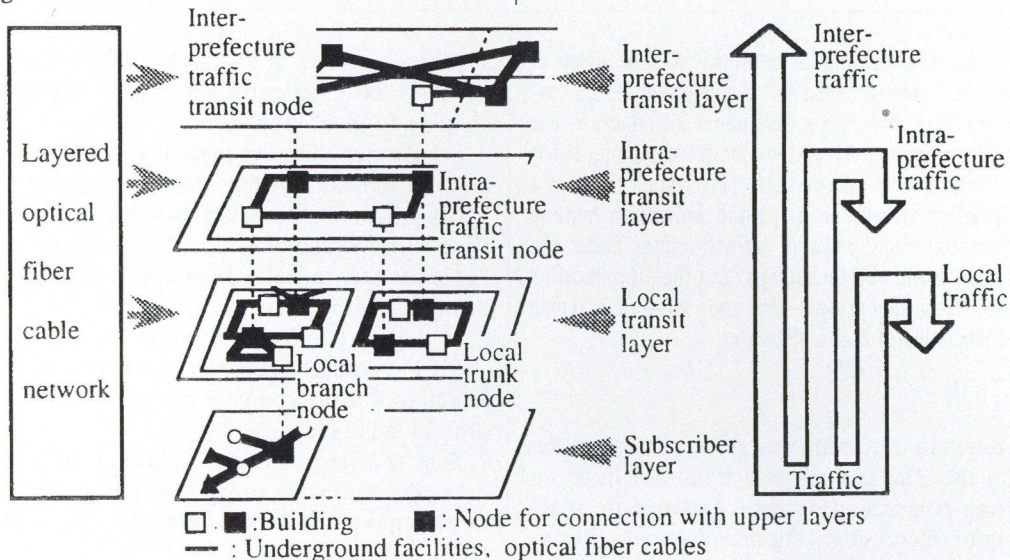

Fig. 2. Optical fiber cable networks

### 3. NETWORK PLANNING SYSTEM

A network-infrastructure planning system that uses geographical information has been developed. Geographical information including roads, bridges, railways, and area

development plans is important for efficient infrastructure planning. This system can display such information on maps to support the judgement of a manager or planner. The system has three subsystems, as shown in Fig. 3.

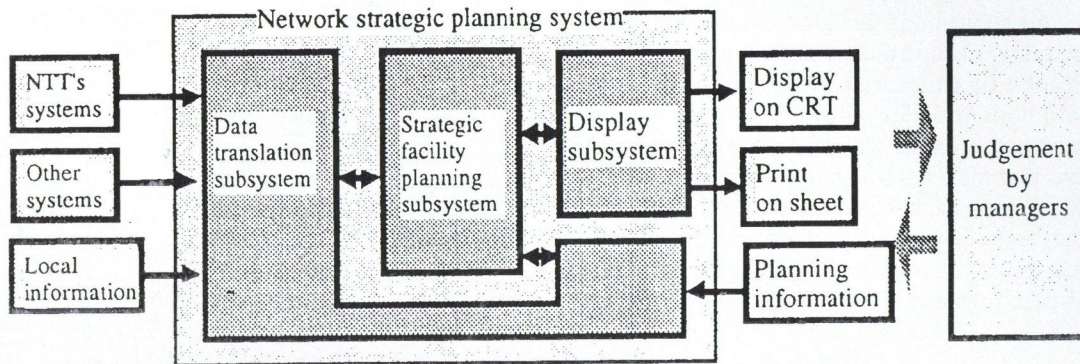

Fig. 3. Structure of network strategic planning support system

#### 3.1. Display subsystem

The Display subsystem displays useful information on maps. The maps show roads, railways, rivers, terrain, and area boundaries, which are important in planning fundamental and basic facilities. The map also shows social and economic statistics, customer statistics, traffic flow, current NTT facilities, and planned facilities.

#### 3.2. Facility Planning subsystem

The strategic Facility Planning subsystem has four main functions: marketing, physical-route selection, network evaluation, and facility planning.

##### 3.2.1. Function 1: Marketing

The Marketing function provides demand and traffic



analysis, forecasting, and correlation analysis between social statistics and customer trends concerning access and transit networks. This function indicates future customer trends. Fig. 4 shows the number of subscribers in the distribution areas.

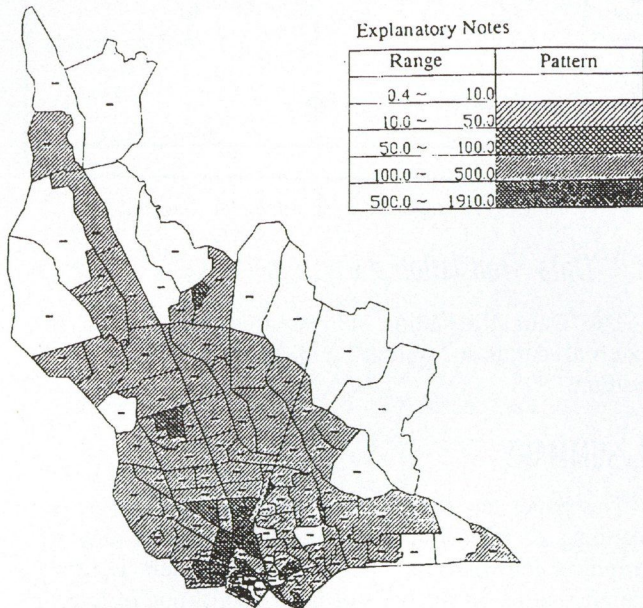

Fig. 4. Number of Subscribers in distribution areas

Using this information, we discuss the methods that can be used to forecast the demand for various services: telephone, ISDN, and other newer telecommunications services [2]. Forecasting the demand for these services is very important for the economical and effective construction of advanced telecommunications networks.

### 3.2.2. Function 2: Route Selection

Underground facility information is stored and managed on meshed maps like the one shown in Fig. 5. Each point in this figure indicates a building or manhole. They are numbered beginning with 1.

When there is an underground facility between point  $i$  and  $j$ , the cost to set up a new facility is determined by  $c_{ij}$ :

$$c_{ij} = \begin{cases} u \cdot d_{ij} & : v_{ij} - p > 0 \\ (w + u) \cdot d_{ij} & : v_{ij} - p \leq 0. \end{cases}$$

Where,  $u$  is the cost of cables and  $w$  is that of underground facilities.  $d_{ij}$  is the distance and  $v_{ij}$  is the vacancy between point  $i$  and  $j$ . Because the ground conditions are stored in the system, important information about ground conditions, especially how weak it is, can be easily accessed. When the ground condition is bad,

$$c_{ij} = \infty.$$

To regulate excavation, and determine the involved difficulty in crossing rivers and railroads, we apply:

$$c_{ij} = \begin{cases} u \cdot d_{ij} & : v_{ij} - p > 0 \\ \infty & : v_{ij} - p \leq 0. \end{cases}$$

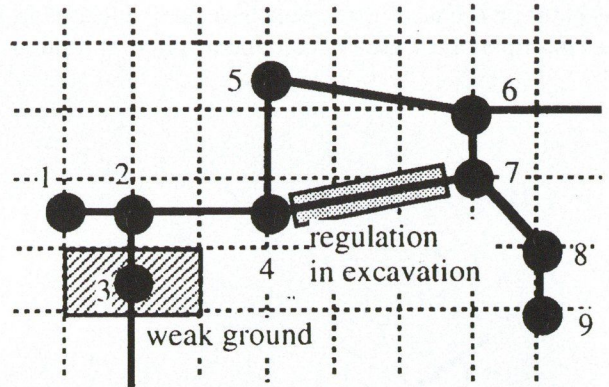

Fig. 5. Facility management using geographical information

The route minimizing the sum of  $c_{ij}$  is determined easily by Dijkstra's method [3].

The process of obtaining the optimal route is explained below.

- (1) Pick a start point  $o$  and end point  $t$  on a map. It is shown in Fig. 6.
- (2) Input the area in which to select the optimal route.
- (3) The system then selects it. An example of this is shown in Fig. 7.

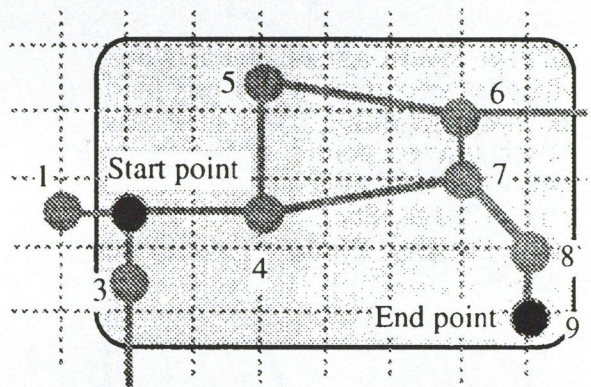

Fig. 6. Specifying a start and end point, and the area for route selection

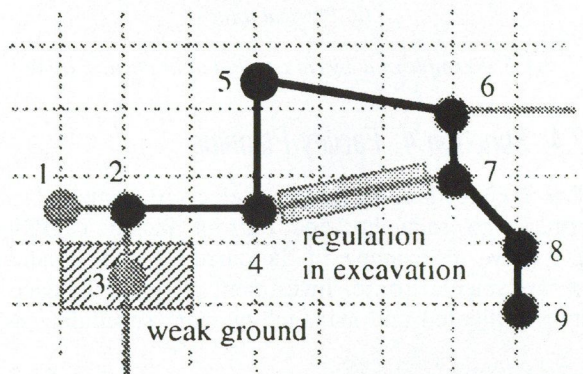

Fig. 7. Example of route selection

### 3.2.3. Function 3: Network Evaluation

The Network Evaluation function estimates the cost efficiency of telecommunications facilities, the network operation simplicity, and the reliability of telecommunications networks. This is done by relating the physical networks to logical ones. It can also simulate changes in logical circuits



and paths on the maps that would have great effects. Fig. 8 is an example of a logical circuit and its physical route.

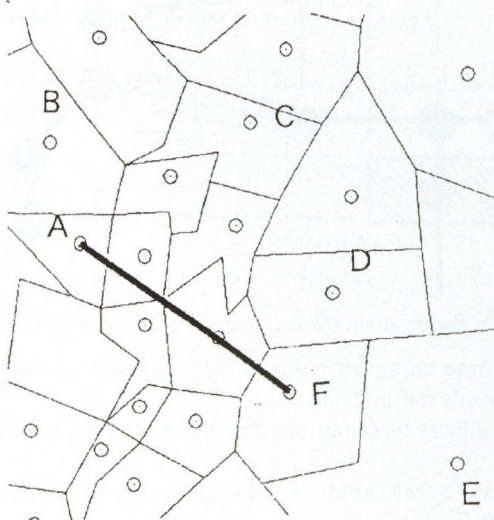

(a) Logical circuit

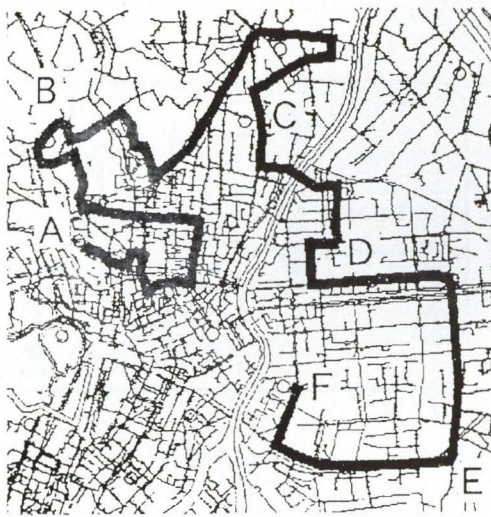

(b) Physical route

Fig. 8. Example of a logical circuit and its physical route

### 3.2.4. Function 4: Facility Planning

The Facility Planning function selects fundamental routes according to reliability and current facility conditions. Fig. 9 shows an example of the current facility conditions of a fundamental route. Investment planning for each facility route is evaluated and managed by work scheduling using

## REFERENCES

- [1] T. Sato: "Outline of Network Planning in NTT", *Proc. Asian ISDN Council*, 1992.
- [2] G. Kimura, Y. Hoshiai and M. Inoue: "Service Demand

PERT diagrams.

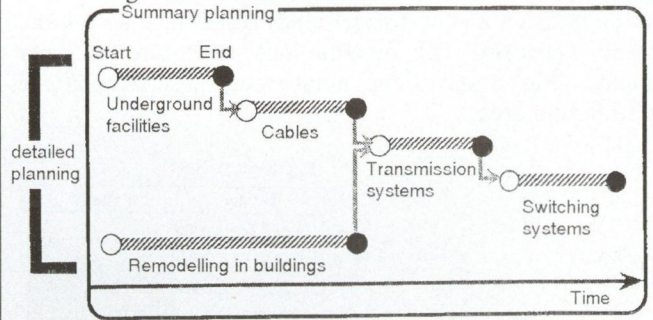

Fig. 9. Facility planning using PERT diagrams

### 3.3. Data Translation subsystem

The Data Translation subsystem translates data from external database systems and provides data to other systems.

## 4. SUMMARY

This paper has proposed a system for strategic network planning of telecommunications facilities that uses geographical information. The proposed system is used to plan networks on the basis of the classification of telecommunications facilities. This information system can be used by a manager or planner to analyze an investment plan by simulation on the display of an engineering workstation.

### 4.1. Implementation

The network planning system and the result of it can be seen on Fig. 10. It emphasizes the importance of the digital map. It can be used later on not only as a design tool but it is an excellent maintenance support too. The system was applied in several networks e.g. for the highly sophisticated problems of Tokyo.

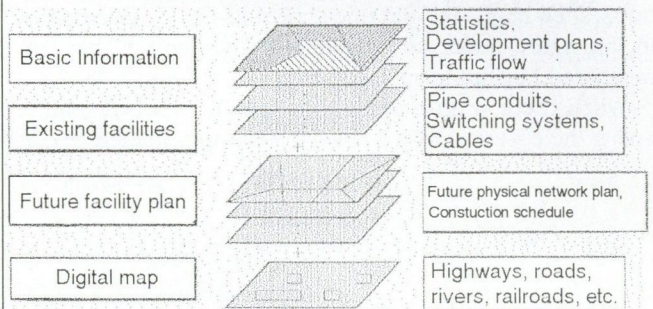

Fig. 10. Display subsystem

- Forecasting and Advanced Access Network Architecture", *ITC 14*, 1994.
- [3] R. E. Tarjan: "Data Structures and Network Algorithms", *The Society for Industrial and Applied Mathematics*, 1983.



## DEVELOPING AN AUDIO CODING DEMONSTRATION PACKAGE FOR EDUCATIONAL PURPOSES

B. KALOTAY, GY. MAROSI and P. TATAI

TECHNICAL UNIVERSITY OF BUDAPEST  
DEPARTMENT OF TELECOMMUNICATIONS AND TELEMATICS  
SZTOCZEK U. 2. H-1111 BUDAPEST, HUNGARY

Nowaday's state-of-the-art telecommunication applications make use of various sophisticated audio signal coding methods. Therefore during the studies of telecommunications it is of primary importance to get familiarized with these methods. However, the theoretical knowledge is more effective if it is supported by practical experiences. Audible presentation gives personal experience, which can help to understand the underlying theory of these algorithms. Our goal was to develop an efficient and easy-to-use demonstration package for educational purposes, which supports the presentation of the subject of the lectures, and on the other hand, can be used for experiments in the laboratory or at home, thus giving a tool for learning by playing. The Microsoft Windows graphical environment provides a user-friendly interface for this package. To ensure reproducibility the software works with prerecorded audio files in the standard RIFF Wave format, and the processed audio signals are stored in the same format [1]. This feature also provides the possibility of comparing the original signal to the encoded-decoded signal in case of various coding parameters. With the on-line help of the package one can quickly look up the theoretical background and the meaning of the adjustable parameters of the coding technique being demonstrated. In this paper an overview of the Low bit-rate Audio Signal Coding (LASC) demonstration package and the summary of the project are presented. The regularly updated version of the LASC demo program can be obtained free of charge via anonymous ftp from our FTP site ([bme-tel.ttt.bme.hu](ftp://bme-tel.ttt.bme.hu)) through the Internet.

### 1. INTRODUCTION TO THE DEMONSTRATION PACKAGE

#### 1.1. The environment

Research in the field of digital voice processing has started many years ago. When it appeared in education, a need arose for an easy-to-use environment to study the different coding techniques, their advantages, disadvantages and the artefacts caused by them. Some years ago requirements met possibilities because the increasing calculating power and storage capacity of computer systems made presentation of different digital voice processing techniques possible without the need of special dedicated hardware elements. Development of such an environment for digital image processing was started on a Unix (Sun) platform under OpenWindows and a part of this was ported to MS-Windows later [2]. In the same manner an environment was developed for digital voice processing on an IBM-PC platform under MS-Windows. Based on this environment a demonstration package was made up to enable experimenting with various voice coding algorithms without the need of bothering about their actual implementation [3].

The regularly updated version of this demonstration package can be anonymous ftp'd from [bme-tel.ttt.bme.hu](ftp://bme-tel.ttt.bme.hu).

#### 1.2. The package

As today, our Low bit-rate Audio Signal Coding demonstration package (LASC Demo) contains five modules, namely: Subsampling, Pulse Code Modulation (PCM), Differential Pulse Code Modulation (DPCM), Sub-band Coding, and Distortions. All parts present different coding techniques, with their particular properties and effects. There are several adjustable parameters for each method, and the result of various settings can be audibly listened, visually observed and compared. Audible presentation gives a personal experience, which can help to understand the underlying theory of these algorithms.

All graphical user interfaces of the existing modules are developed in the same manner. They are fully menu-driven, all one has to do is to select certain parameter combinations by clicking buttons and setting scroll bars on the screen, and to apply them to the selected input waveform. Original and coded waveforms are placed into a waveform player application's stack with legends showing the actual parameter settings. Besides these, numerical results (such as SNR, actual bit-rate, optimal coefficients, etc.) are displayed for each coded waveform. The player application plays the waveforms in an arbitrary order, or displays them in separate windows where parts of the waveforms can be magnified by given factors to study the finer details. The displayed waveforms can also be printed or inserted into documents. Windows can be moved around the screen and placed to the desired position by drag-and-drop operations, as well as they can be removed from the screen.

In computer simulations (as is the case with the demonstration package) stored waveforms are used instead of an analogue input to ensure reproducibility. These waveforms are stored in the standard RIFF WAVE format, which means a variable-length information header followed by the digitized audio data [1]. The demo works with audio files quantized to 16 bits or less. In the demonstration package all modules use mono (i.e., single-channel) waveforms. There are ten waveforms distributed together with the demonstration package; some of them are stand-alone words, some of them are whole sentences, and there are some special signals, e.g., a chirp signal [4], etc.

The modules described in this section are now available for evaluation.



## 2. THE IMPLEMENTED MODULES OF THE DEMONSTRATION PACKAGE

### 2.1. Common features of the Graphical User Interfaces (GUIs)

First let us discuss the parts that do not change throughout the whole demonstration package, using the Subsampling GUI as an example, shown in Fig. 1.

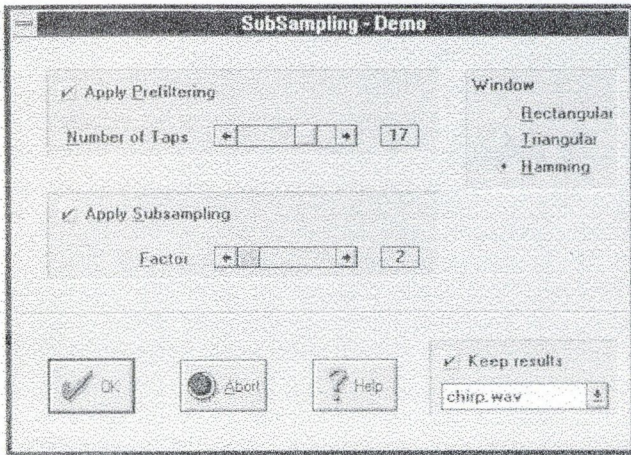

Fig. 1. Graphical User Interface of the Subsampling demo

At the top the standard MS-Windows dialog box caption and the system menu box can be found [5]. Below the caption there are the switches and parameter-settings that can be adjusted for the corresponding coding method. After setting them to the desired values, pressing the OK button will start the process. A new window appears on the screen; it contains the completion scale during the calculations, the numerical information and results. In the same row a Help button can be found to display context-sensitive on-line Help pages about the module being used at the moment.

During the procedure — among other coding results — the actual parameters, the optimal prediction coefficients, the mean-squared error, and the signal-to-quantization noise ratio are displayed in the calculation window. Since these objects have the same meaning in each demonstration module, they will not be mentioned hereafter.

In the following a short summary of the existing modules (namely Subsampling, Quantization (PCM), DPCM, Sub-band Coding, and Distortions) is presented.

### 2.2. Subsampling

In the particular implementation of the GUI of the Subsampling demo (Fig. 1.) the subsampling process can be switched on or off. If subsampling is applied to the input signal, then the factor of the sampling rate reduction can be set. Selectable factors are the powers of two, ranging from 2 to 32. Due to the sampling theorem, the input (original) waveform should be bandlimited before subsampling [6]. The number of the taps of the anti-aliasing FIR filter can be set from 5 to 21 for studying its effects. The windowing function used in the design of the anti-aliasing filter can be either Rectangular, Triangular, or

Hamming [7]. For experimental purposes the bandlimiting step can be skipped, one can study the artefacts of aliasing.

### 2.3. Quantization (PCM)

In the PCM [8] demo the number of bits per sample can be set, thus determining the number of possible values representing the sample and the actual bit-rate. The quantizer characteristic is also selectable from the set of:

Mid-tread, Mid-riser, — to demonstrate the difference between these two types of the uniform quantizers [9].

A-law,  $\mu$ -law, — to present the standard companding curves used in the world-wide telecommunication network [8].

Laplace and Gamma - to evaluate optimized quantizing characteristics [7] for signals with probability density functions defined as follows:

$$f_{Laplace}(x) = \frac{1}{\sqrt{2}\sigma_x} \cdot e^{-\frac{\sqrt{2}|x|}{\sigma_x}}$$

$$f_{Gamma}(x) = \sqrt{\frac{\sqrt{3}}{8\pi \cdot \sigma_x}} \cdot e^{-\frac{\sqrt{2}|x|}{2\sigma_x}}$$

The so called dithering method can be applied as well, which is common in image coding [2], [9], or this step can be switched off. The dithering signal is a broadband pseudo-random noise signal, which is available both at the coder and at the decoder sides. The level of the pseudo-random sequence is adjustable.

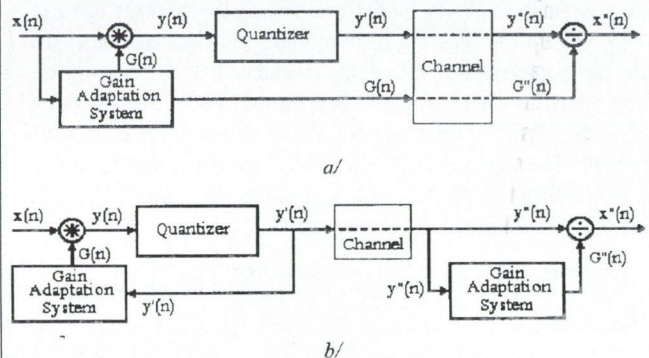

Fig. 2. The feedback (a) and the feed-forward (b) structures for gain adaptation of quantizers

The transmitting channel between the sender and the receiver sides can be modelled as an error-free or as an erroneous channel with a certain bit error probability. For simulating the latter a symmetric, memoryless random bit error generator with constant probability is applied. Although applications in practice often use error protection, here it is not used because the aim is to illustrate the effect of bit errors in the core coding method.

Adaptation in the quantization process can be applied with either feed-forward or feedback structure, and the alpha parameter i.e. the time constant of the gain adaptation can be set [7]. The above mentioned adaptation structures are depicted in Fig. 2.

### 2.4. DPCM

In the demo, experiments can be made with differential quantization [9] in case of various parameter settings. Two different types of prediction structures, namely the feed-



forward and the feedback structure, can be applied to see what influence they have on the output waveform.

By setting the switches of the DPCM demo GUI, prediction with order of 1, 2, or 3; the actual prediction model (feed-forward or feedback); the bit-rate, which means the number of bits per sample; and the characteristics of the prediction error signal quantizer can be selected.

The transmitting channel between the coder and the decoder sides can be simulated to be error-free or erroneous with selectable bit error probability as for PCM.

Adaptation in the quantization process can also be applied in the same way as it was mentioned in 2.3.

## 2.5. Sub-Band Coding

The sub-band coding module provides various parameter settings for the hands-on experiments. The number of sub-bands can be set between 2 and 128 to see what influence it has on the output waveform. The sub-band decomposition has been implemented by using a tree structured biresiprocal wave digital filter bank [10], [11].

By setting the switches the number of sub-bands and the average bit-rate, which is determined by the total number of bits for all channels, can be selected. Types of quantizers used to encode the signals of each sub-bands can be chosen as well.

The total number of bits for all channels is distributed among the channels according to their power. The power distribution of the sub-bands was determined experimentally during the period of the development for the following three types of input signals: test, music and speech. For the quantization process one of these power distribution models can be selected as well. Since it can be interesting to examine the signals of sub-bands individually, the output can be set to be either the reconstructed signal or the set of sub-band signals.

Moreover, the transmission channel can be modeled to be error-free or erroneous, and in the latter case the bit error probability can be set.

## 2.6. Distortions

This module provides various distortion effects. By setting the switches the input gain can be set; emphasis with various time constant and additive white or pink noise of arbitrary level can be applied. The block diagram of the module is depicted on Fig. 3.

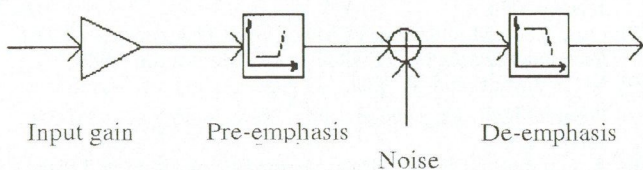

Fig. 3. Block diagram of the Distortions module

The input gain can be varied between -50 dB and +50 dB, which means an amplification with a constant between approximately 0.00316 and 316.

Pink noise is obtained by applying the following filter to a white noise:

$$H_{pink}(z) = a \cdot \frac{1 - z^{-1}}{c_1 + c_2 \cdot z^{-1}},$$

where  $a$  is obtained from the following integral to provide the given level of noise:

$$a = \frac{1}{\sqrt{\frac{1}{\pi} \cdot \int_0^{\pi} \left| \frac{1 - z^{-1}}{c_1 + c_2 \cdot z^{-1}} \right|_{z=e^{j\vartheta}} d\vartheta}}$$

and the constants are:

$$c_1 = \frac{1 + 2 \cdot f_{sr} \cdot \tau'_N}{2 \cdot f_{sr} \tau'_N}, \quad c_2 = \frac{1 - 2 \cdot f_{sr} \cdot \tau'_N}{2 \cdot f_{sr} \tau'_N},$$

$$\tau'_N = \frac{1}{2 \cdot f_{sr} \cdot \tan \frac{1}{2 \cdot f_{sr} \cdot \tau_N}}, \quad \text{and} \quad \tau_N = \frac{1}{2 \cdot \pi \cdot 0.99 \cdot \frac{f_{sr}}{2}}$$

where  $f_{sr}$  is the sampling frequency and  $\tau_N$  is the adjustable time constant of the noise shaping filter.

The applied pre- and de-emphasis filters are complementary,

$$H_{pre}(z) = \frac{(1 + 2 \cdot f_{sr} \cdot \tau'_0) + (1 - 2 \cdot f_{sr} \cdot \tau'_0) \cdot z^{-1}}{(1 + 2 \cdot f_{sr} \cdot \tau'_p) + (1 - 2 \cdot f_{sr} \cdot \tau'_p) \cdot z^{-1}},$$

and

$$H_{de}(z) = \frac{1}{H_{pre}(z)'}$$

respectively. The constants are:

$$\tau'_0 = \frac{1}{2 \cdot f_{sr} \cdot \tan \frac{1}{2 \cdot f_{sr} \cdot \tau_0}}, \quad \text{and} \quad \tau'_p = \frac{1}{2 \cdot f_{sr} \cdot \tan \frac{1}{2 \cdot f_{sr} \cdot \tau_p}}$$

Here  $\tau_0$ , which is proportional to the frequency for which  $H_{pre}(z)$  is zero, can be adjusted between 40 and 140  $\mu$ s (in radio systems the OIRT standard is  $\tau_0 = 50 \mu$ s and the CCIR standard is  $\tau_0 = 75 \mu$ s). The pole of the pre-emphasis filter is chosen to be constant:

$$f_p = \frac{1}{\tau_p} = 2 \cdot \pi \cdot 0.99 \cdot \frac{f_{sr}}{2}$$

Pre-emphasis can be applied with or without de-emphasis for educational purposes.

All-pass filters to demonstrate phase distortion are under development.

## 3. MISCELLANEOUS PROGRAMS

### 3.1. The Waveform Player Application

The encoded and decoded signals generated by the above detailed coding modules are transferred to the waveform player application. This application supports the audible presentation of the output signals.

On the graphical user interface of the application a list can be found, which can contain up to ten encoded-decoded waveform names and short legends of the parameters used in the coding process. The elements of the list are numbered from 0 to 9, and beside the serial number of a particular element a check-box can be found. By checking in some of these boxes in an arbitrary order one can form a group of waveforms for the presentation; this



order is displayed under the list. Pressing the Say button the elements of the group can be played via practically all commercial sound cards used in PCs.

### 3.2. The Waveform Viewer Application

The checked-in items of the list in the waveform player application can be visualized simply by pressing its Show button. This action invokes the waveform viewer application (WinWView), which is a powerful tool to study the encoded and decoded waveforms visually, see Fig. 4. The program shows both the whole signal and a magnified part of it. The magnified part of the signal can be selected by zooming either into the original signal or into the zoomed one. A menu point provides two different linestyles to study the details. The viewer application positions itself neatly so that each previous instance remains visible. This feature provides the opportunity of studying several waveforms on the display at the same time. FFT, DFT, and color spectrogram features [6] are under development and will be implemented in the near future.

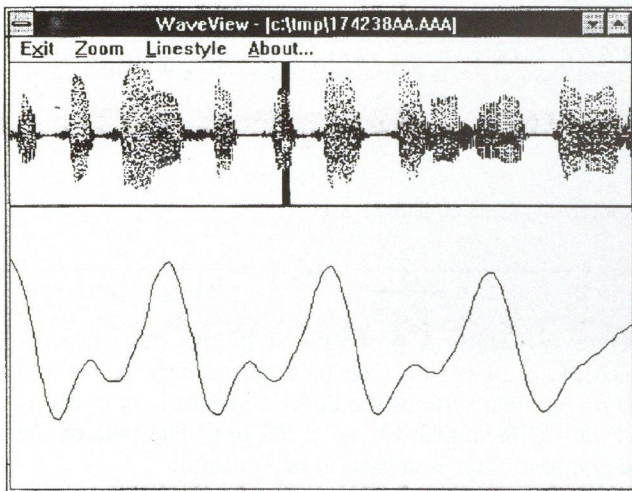

Fig. 4. The Waveform Viewer Application (WinWView)

## REFERENCES

- [1] Microsoft Windows Software Development Kit (SDK), Microsoft Corporation, Ireland, 1992.
- [2] Gy. Marosi: A Video Coding Demonstration Package, Delft University of Technology, 1993.
- [3] B. Kalotay and Gy. Marosi: Low Bit-Rate Audio Signal Coding Demonstration Package, TEMPUS Conference, Budapest, 1994.
- [4] Automatic Speech Recognition, OTKA Report, Department of Telecommunications and Telematics, Budapest, 1994.
- [5] Ch. Petzold: Programming Windows: The Microsoft guide to writing applications for Windows 3.1, Microsoft Press, 1992.
- [6] G. Gordos and Gy. Takács: Digitális beszédfeldolgozás, Műszaki Könyvkiadó, Budapest, 1983.

## 4. CONCLUSIONS

In the previous sections an audio signal coding demonstration package has been presented. The fact that it has been used for the hands-on experiments of several lectures proves its usefulness. The modular and flexible structure of the package enables to include further coding methods; many modules are planned and some of them are under development.

The Waveform Player and the Waveform Viewer applications provide the opportunity of audible and visual comparison of signals coded using different methods or parameters.

The Microsoft Windows environment supports the insertion of the results into documents in a very convenient way.

On-line help pages are accessible for every module of the demonstration package, giving quick references about the basics of a particular coding method or the usage of the graphical user interface. Moreover, the on-line help provides a short guide for beginners to obtain interesting results with the demonstration package.

At this phase of the project the following modules of the demo are planned or under development: a G.721 ADPCM coder; a module, that demonstrates the LPC techniques and their performance; CELP coders working with various bit-rates; a 16 kbps GSM coder; and a module that demonstrates the artefacts of vector quantization. These modules are intended to be released in the near future.

The regularly updated version of the LASC demo program can be obtained free of charge via anonymous ftp from our FTP site (*bme-tel.ttt.bme.hu*) through the Internet.

## 5. ACKNOWLEDGEMENTS

We acknowledge the basic idea of the demonstration package from the Information Theory Group of Delft University of Technology [2]. Many thanks are due to the students, in particular to Bálint Lükő, József Vass, and Zoltán Völgyesi for their contribution to the project.

- [7] L. R. Rabiner and R. W. Schafer: Digital Processing of Speech Signals, Prentice-Hall, Inc., Englewood Cliffs, New Jersey, 1978.
- [8] Pulse Code Modulation (PCM) of Voice Frequencies, *CCITT Recommendation, G.711*, Blue Book, Melbourne, 1988.
- [9] N. S. Jayant and P. Noll: Digital Coding of Waveforms, Prentice-Hall, Englewood Cliffs, New Jersey, pp. 261-266, 1984.
- [10] A. Gersho and R. M. Gray: Vector Quantization and Signal Compression, Kluwer Academic Publishers, Boston, 1993.
- [11] R. E. Crochiere: Sub-band Coding, *Bell System Tech. J.*, pp. 1633-1654, September 1981.





# JOURNAL ON COMMUNICATIONS 1995

In 1995 we are continuing the practice of publishing alternately English and Hungarian issues. English issues will be devoted to topics in which activities and events in Hungary may be of international interest. Hungarian issues will be surveying important topics of telecommunications related to our domestic development.

The topics of the planned issues are the followings:

## English issues

- PHOTONICS
- BROADCASTING
- NOISE
- ATM NETWORKS
- MOBILE COMMUNICATIONS (double issue)

## Hungarian issues:

- SECURE COMMUNICATIONS
- FREQUENCY MANAGEMENT
- COMPUTER NETWORKS
- INTELLIGENT NETWORKS
- TELECOMMUNICATIONS IN GERMANY (double issue)

1 year subscription rates:

**6 English issues 72 USD**

**12 English and Hungarian issues 108 USD Single issues 20 USD**

Subscription orders should be sent to the publisher:

**Typotex Ltd.**

**Budapest, Retek u. 33-35. H-1024. Phone/Fax: (36-1)115-1759.**

## Information for authors

JOURNAL ON COMMUNICATIONS is published monthly, alternately in English and Hungarian. In each issue a significant topic is covered by selected comprehensive papers.

Other contributions may be included in the following sections:

- INDIVIDUAL PAPERS for contributions outside the focus of the issue,
- PRODUCTS-SERVICES for papers on manufactured devices, equipments and software products,
- BUSINESS-RESEARCH-EDUCATION for contributions dealing with economic relations, research and development trends and engineering education,
- NEWS-EVENTS for reports on events related to electronics and communications,
- VIEWS-OPINIONS for comments expressed by readers of the journal.

Manuscripts should be submitted in two copies to the Editor in chief (see inside front cover). Papers should have a length of up to 30 double-spaced typewritten pages (counting each figure as one page). Each paper must include a 100–200 word abstract at the head of the manuscript. Papers should be accompanied by brief biographies and clear, glossy photographs of the authors. Contributions for the PRODUCTS-SERVICES and BUSINESS-RESEARCH-EDUCATION sections should be limited to 16 double-spaced typewritten pages.

Original illustrations should be submitted along the manuscript. All line drawings should be prepared on a white background in black ink. Lettering on drawings should be large enough to be readily legible when the drawing is reduced to one- or two-column width. On figures capital lettering should be used. Photographs should be used sparingly. All photographs must be glossy prints. Figure captions should be typed on a separate sheet.



# SIEMENS

## A new vision of freedom and mobility

On the threshold of the 21st century, we see the electronic, entertainment, information and service sectors of our economy merge into the digital Main Street of the Global Village. On this street, we meet and communicate with people, are entertained and informed, consume, play, and work. This

evolution of multimedia telecommunications will entrust all of our life styles to our most constant companion - change. As the No. 1 systems integrator, Siemens has all that is needed to affect this change. 150 years of experience in developing networks, global presence,

local strength, reliability and dependability, right from the start.

Siemens Telefongyár Kft  
Tel.: (36-1) 252-0222  
Fax: (36-1) 252-2749

