



**MZ NDU AVIATION TECHNICAL INSTITUTE**

# **BULLETINS IN AERONAUTICAL SCIENCES**

**PROCEEDINGS  
OF THE  
1<sup>ST</sup> INTERNATIONAL SYMPOSIUM ON  
„FUTURE AVIATION TECHNOLOGIES”  
FAT 2002**

**XIV. VOL. 1.**

**2002.**



**PERIODICAL PUBLICATION OF  
MIKLÓS ZRÍNYI NATIONAL DEFENSE  
UNIVERSITY**

**Bulletins in Aeronautical Sciences**  
**XIV. Vol. 1.**  
**2002.**

**A ZRÍNYI MIKLÓS NEMZETVÉDELMI EGYETEM  
TUDOMÁNYOS LAPJA**

**Szerkesztette:**

Dr. Szabolcsi Róbert  
Békési Bertold

**A szerkesztőség címe:**

5008, Szolnok, Kilián út 1.  
Telefon: 56-343-422 (48-75 mell.)

**Szerkesztőbizottság:**

Dr. Péter Tamás, dr. Pokorádi László, Varga Béla, dr. Szántai Tamás  
Bottyán Zsolt, dr. Pintér István, dr. Óvári Gyula, Kovács József, Békési Bertold  
dr. Rohács József, dr. Gedeon József, dr. Szabó László, dr. Szabolcsi Róbert,  
Vörös Miklós.

**Lektorai Bizottság:**

Dr. Péter Tamás, dr. Pokorádi László, dr. Szántai Tamás, dr. Pintér István,  
dr. Óvári Gyula, dr. Rohács József, dr. Gedeon József, dr. Szekeres István  
dr. Szabolcsi Róbert, dr. Horváth János, dr. Gausz Tamás, dr. Sánta Imre  
dr. Pásztor Endre, dr. Kurutz Károly, dr. Nagy Tibor, dr. Ludányi Lajos  
dr. Kuba Attila, dr. Jakab László.

Felelős kiadó: Dr. Szabó Miklós, a Zrínyi Miklós Nemzetvédelmi Egyetem rektora

Felelős szerkesztő: dr. Hadnagy Imre József

Tervezőszerkesztő: Békési Bertold

Készült a Zrínyi Miklós Nemzetvédelmi Egyetem Repülőműszaki Intézet nyomdájában, 200 példányban

Felelős vezető: Szepesi János

**ISSN 1417-0604**

## TABLE OF CONTENTS

<b>Program of the 1<sup>st</sup> International Symposium on Future Aviation Technologies</b>	<b>7</b>
<b>GODZIMIRSKI, Jan—ZALEWSKI, Piotr</b> Aviation Education on Military University of Technology, Warsaw	<b>17</b>
<b>SUNDQVIST, Bengt-Göran—PERSSON, Andreas—PELLEBERGS, Johan</b> Automatic Aircraft Collision Avoidance System for Air Combat Maneuvering	<b>23</b>
<b>Klára Siposné KECSKEMÉTHY—KORMOS, László</b> Remarks and Ideas about Future Aviation Technologies Symposium and Military Aircraft Personnel Training	<b>27</b>
<b>RADUCANU, Dan</b> Integrated Image Intelligence System (I3S)	<b>33</b>
<b>MRÁZ, István</b> Leadership Qualities on the Future Battlefield	<b>39</b>
<b>SZABOLCSI, Róbert—SZEGEDI, Péter</b> Design of the Chebyshev BR Filter for the Elastic Aircraft Longitudinal Stability Augmentation System	<b>43</b>
<b>Ms. MOLDOVAN, Elena—JULA, Nicolae—LUPAS, Anca</b> Pressure Microtransducers as Dynamic Linear Systems	<b>53</b>
<b>DUNAI, Pál</b> Practical and Psychological Aspects of the Training Process for the Guided by their Abilities Hungarian Military Forces in the 21 <sup>st</sup> Century	<b>59</b>
<b>PADÁNYI, József</b> Engineer Support to SFOR Air Operations	<b>65</b>
<b>STANCIU, Virgil—BOSCOIANU, Mircea</b> Contributions to the Study of an Axial Compressor Stage by the Means of the Generalized Reaction Degree Concept	<b>73</b>
<b>DANCZIK, Ján—HÝBL, Miroslav</b> Automatic Landing System for UAV	<b>79</b>
<b>LUŽICA, Štefan</b> Distortion Solution of the ILS Localizer Course Line by PC Support	<b>87</b>

<b>SIKLÓSI, Zoltán</b> The NATO Standard Safety Investigation Procedures which should be Integrated into Home Regulations	<b>95</b>
<b>GRECMAN, Pavel</b> Utilization of Self-protect Systems on Recent Helicopters Used by Czech Air Force	<b>101</b>
<b>VARGA, Béla</b> Noise Reduction Methods of Modern Single Rotor Helicopters	<b>107</b>
<b>KULCSÁR, Balázs—KORODY, Endre</b> Pull-Up from a Dive	<b>115</b>
<b>JAKAB, László</b> Experiences of Command Sergeant Major (CSM) Course in the Air Force	<b>121</b>
<b>ANDRLE, Milos</b> Using of the Data Output of the Modernized Precision Approach Radar for Aircraft Navigation	<b>131</b>
<b>VOSECKÝ, Slavomír</b> Integrated Fix Information	<b>139</b>
<b>TKÁČ, Jozef—ŠPIRKO, Štefan—BOKA, Ladislav</b> Radar Target Detection with Reduced Radar Cross Section	<b>147</b>
<b>POKORÁDI, László</b> Fuzzy Logic-Based Maintenance Decision	<b>153</b>
<b>OLEJNIK, Aleksander—KACHEL, Stanislaw—LESZCZYŃSKI, Piotr</b> Recreation and Evaluation of the Aging Aircraft Structure for the need of Life-time Extension	<b>159</b>
<b>HUSI, Géza</b> Why I like the $(ax^2 + b)/x$ function?	<b>167</b>
<b>TÓTH, Sándor</b> Values, Harmony, Social and Army	<b>173</b>
<b>RÁSA, László</b> Models of Changing Organisational Cultures Adequate to the Reorganisation of the Hungarian Defence	<b>179</b>
<b>PINTÉR, István</b> Levels of Leadership	<b>185</b>

<b>BÁNYAI, Kornél</b>	
Military Background and Leadership Skills in the Business Life	<b>191</b>
<b>PETÁK, György—BÉKÉSI, Bertold</b>	
Gripen for Hungary. Why the Gripen is the Best Solution	<b>203</b>
<b>ZALEWSKI, Piotr</b>	
Selected Aspects of the Modern Fighters Evaluation	<b>209</b>
<b>BOSCOIANU, Mircea—STANCIU, Virgil</b>	
An Analysis of the Axial Flow Compressor Stability Using the Bifurcation Theory	<b>217</b>
<b>ROTARU, Constantin</b>	
Issues about Aircraft Turbojet Engines Control Laws	<b>223</b>
<b>MAKULA, Petr</b>	
Data Link Conception for Joint Tactical Unmanned Aerial Vehicles Based on STDMA Protocol	<b>229</b>
<b>HAMMARBERG, Bengt—BERGLUND, Hans</b>	
The SAAB NetDefense Concept	<b>235</b>
<b>LUDVÍK, František—MARTIN, Šimaček</b>	
Unmanned Air Vehicles – Critical Target	<b>251</b>
<b>MARINESCU, Marin—MATEI, Lucian</b>	
Fuzzy Control of the Antilock Braking System of the Plane's Landing Gear	<b>257</b>
<b>BOJDA, Petr</b>	
Algorithm Computing Electromagnetic Wave Scattering from Rough Surfaces	<b>265</b>
<b>Resume</b>	<b>273</b>



**MIKLÓS ZRÍNYI NATIONAL DEFENSE UNIVERSITY  
BOLYAI JÁNOS MILITARY TECHNICAL FACULTY  
AVIATION TECHNICAL INSTITUTE**

# FAT 2002

**1<sup>ST</sup> INTERNATIONAL SYMPOSIUM ON  
„FUTURE AVIATION TECHNOLOGIES”**



**FINAL PROGRAM OF THE SYMPOSIUM**

**12-13-14 APRIL, 2002  
Budapest–Szolnok, Hungary**



## **PATRONS OF THE CONFERENCE**

*DR. FARKAS TIVADAR*

Deputy State Secretary for Human Policy

*PROF. DR. SZABÓ MIKLÓS*

Academician, Rector

*PROF. DR. SZABÓ JÓZSEF,*

Hungarian Association of Military Sciences, president

*PROF. DR. SOLYMOSI JÓZSEF*

PhD School of Military and Technical Sciences, leader

*PROF. SZABÓ JÁNOS*

Director

*COL. CZIMMER ISTVÁN LÁSZLÓ*

MoD, Education and Science Department, Head of Department

*MAJ. GEN. BALOGH IMRE,*

HDF Air Force Command, Commander

## **SCIENTIFIC COMMITTEE**

Prof. Dr. Col. Klára Siposné Kecskeméthy, MoD, Education and Science  
Department, Chief of Devison

Prof. Dr. Turcsányi, Károly, MZNDU, Deputy Dean

Prof. Dr. Col. Szilágyi, Tivadar, MZNDU, Vice-rector

Dr. Lt. Col. Jakab, László, MZNDU, Head of Department

Prof. Dr. Col. Óvári, Gyula, MZNDU, Director

Dr. Lt. Col. Szabó, László, MZNDU, Deputy Head of Department

Prof. Dr. Col. Berek, Lajos, MZNDU, Head Director

Prof. Dr. Col. Rádli, Tibor, MZNDU, Deputy Head Director

Dr. Lt. Col. Sipos, Jenő, MZNDU, Deputy Head Director

Dr. Galovicz, János, Hungarian Association of Military Sciences, Air Force  
Committee, Chair

Prof. Dr. Pokorádi, László, University of Debrecen

Prof. Dr. Rohács, József, Budapest University of Technology and Economics

Prof. Dr. Kurutz, Károly, Budapest University of Technology and Economics

Mrs. Várkonyi Dr. Kóczy, Annamária, Budapest University of Technology and  
Economics

Dr. habil. Lt. Col. Szabolesi, Róbert, MZNDU, Deputy Director

## **ORGANIZING COMMITTEE**

**Chair:** Dr. habil. Lt. Col. Szabolcsi Róbert

**Members of the Committee:** Maj. Békési Bertold, Capt. Szegedi Péter,  
Bartal Szilvia, Capt. Ildikó Martonosiné, Jeszenyi, Lt. Col. Poroszlai Ákos,  
Capt. Szilágyi Zoltán, Semságné Kádár Márta

## **ORGANIZED BY**

Hungarian Association of Military Sciences, Air Force Committee  
Miklós Zrínyi NDU, Bolyai János Military Technical Faculty  
Miklós Zrínyi NDU, Bolyai János Military Technical Faculty, Aviation  
Technical Institute  
Miklós Zrínyi NDU, Bolyai János Military Technical Faculty, Aviation  
Technical Institute, Department of Aircraft Airframe and Engines  
Miklós Zrínyi NDU, Bolyai János Military Technical Faculty, Aviation  
Technical Institute, Department of Aircraft Onboard Systems  
Hungarian Academy of Sciences, Aviation Technical Group

## **CONFERENCE SPONSORS**

“ALAPÍTVÁNY A LÉGVÉDELEMÉRT”  
„AEROTECHNIKA M & T BUDAPEST RT.”  
„GRADUAL BT”  
„MRSOFT OKTATÁSI ÉS KERESKEDELMI KFT.”  
„RAIFFEISEN BANK RT. SZOLNOKI FIÓK”  
„MAGYAR REPÜLÉSTÖRTÉNETI MÚZEUM ALAPÍTVÁNY”  
„HM ELEKTRONIKAI LOGISZTIKAI ÉS VAGYONKEZELŐ RT.”

## **10<sup>00</sup>—13<sup>45</sup> PLENARY SESSION**

**Chairman:** SZABOLCSI, Róbert

**Co-Chairman:** VOJKOVSKÝ, Frantisek

- 10<sup>00</sup> ÓVÁRI, Gyula:** Greetings to the Conference Participants  
**10<sup>10</sup> FARKAS, Tivadar:** Actual Questions of Management of Human  
Resources Related to Hungarian Defence Forces Re-Organization  
**10<sup>35</sup> VOJKOVSKÝ, Frantisek:** Selection of Pilots for Czech Air Force  
**11<sup>00</sup> RÁTH, Tamás:** CNN Technology  
**11<sup>25</sup> GODZIMIRSKI, Jan—ZALEWSKI, Piotr:** Aviation Education on  
Military University of Technology, Warsaw

**11<sup>50</sup>—12<sup>05</sup> Coffee Break**

- 12<sup>05</sup> **SUNDQVIST, Bengt-Göran—PERSSON, Andreas—PELLEBERGS, Johan:**  
Automatic Aircraft Collision Avoidance System for Air Combat Maneuvering
- 12<sup>30</sup> **Klára Siposné, KECSKEMÉTHY—KORMOS, László:** Remarks and  
Ideas about Future Aviation Technologies Symposium and Military Aircraft  
Personnel Training
- 12<sup>55</sup> **RADUCANU, Dan:** Integrated Image Intelligence System (I3S)
- 13<sup>20</sup> **MRÁZ, István:** Leadership Qualities on the Future Battlefield

13<sup>45</sup>—14<sup>30</sup> Lunch

14<sup>30</sup>—15<sup>30</sup> Visit to the Air Force Museum

15<sup>30</sup>—16<sup>30</sup> SESSION LECTURES I.

**Operation Support and Decision Making**

**Chairman: VOJKOVSKÝ, Frantisek**

**Co-Chairman: SZABOLCSI, Róbert**

- 15<sup>30</sup> **CSUTORÁS, Gábor:** Az ABV védelmi támogatás helye, szerepe főbb  
területei a Légierő művelettámogatási rendszerében
- 15<sup>50</sup> **KURINA, Tibor:** Parancsnoki döntési folyamat modellje
- 16<sup>10</sup> **SZÁSZI, Gábor:** Magyarország katonai repülőtereinek kapcsolódó  
közlekedési infrastruktúra jelenlegi helyzetének vizsgálata az új  
Szövetséges Stratégiai Konceptió tükrében

**Military Education I.**

**Chairman: MRÁZ, István**

**Co-Chairman: SZABÓ, László**

- 15<sup>30</sup> **BÉKÉSI, László—SZABÓ, László:** A multimédia és a virtuális valóság  
alkalmazásának tapasztalatai a MI-8 helikopter tanításában
- 15<sup>50</sup> **FEHÉR, András:** Műholdas navigáció a katonai tereptan oktatásának  
eszközrendszerében
- 16<sup>10</sup> **POROSZLAI, Ákos:** Nyomtatott távoktatási tananyagokkal szemben  
támasztott követelmények

**Multidisciplinary Sciences I.**

**Chairman: SIPOS, Jenő**

**Co-Chairman: SZEGEDI, Péter**

- 15<sup>30</sup> **SZABOLCSI, Róbert—SZEGEDI, Péter:** Design of the Chebyshev BR  
Filter for the Elastic Aircraft Longitudinal Stability Augmentation System
- 15<sup>50</sup> **Ms. MOLDOVAN, Elena—JULA, Nicolae—LUPAS, Anca:** Pressure  
Microtransducers as Dynamic Linear Systems
- 16<sup>10</sup> **SIPOS, Jenő:** A lövészkor fellépő igénybevételek hatása a tüzérségi és  
harckocsi réz hüvelyek meghibásodására

### **Military Sciences**

**Chairman: BEREK, Lajos**

**Co-Chairman: Klára Siposné, KECSKEMÉTHY**

- 15<sup>30</sup> **FÉLEGYHÁZI-TÖRÖK, Imre:** Az egészségügyi kiképzés sajátos feladatai és hatásuk a katonai műveletek sikerére a légierő csapatainál
- 15<sup>50</sup> **DUNAI, Pál:** Practical and Psychological Aspects of the Training Process for the Guided by their Abilities Hungarian Military Forces in the 21<sup>st</sup> Century
- 16<sup>10</sup> **Mrs. MARTONOSI, JESZENYI, Ildikó:** A polgári és katonai kapcsolattartás elemei, jelentősége a NATO AFS STO alapján

### **PhD Student Session I.**

**Chairman: PINTÉR, István**

**Co-Chairman: PALIK, Mátyás**

- 15<sup>30</sup> **KAVAS, László:** Harcászati repülőgépek objektív értékelési lehetősége
- 15<sup>50</sup> **KOVÁCS, László—VÁNYA, László:** Elektronikai hadviselés a XXI. század légijerében
- 16<sup>10</sup> **PALIK, Mátyás:** A pilóta nélküli repülő eszközök hasznos terhelése

### **Operation Support**

**Chairman: GALOVICZ, János**

**Co-Chairman: BÉKÉSI, Bertold**

- 15<sup>30</sup> **VASVÁRI, Tibor:** A logisztika és a művelettámogatás főbb területei a légierőben
- 15<sup>45</sup> **KIS J., Ervin:** Az izraeli hadsereg kialakítása, repülőcsapatának létrejötte és harcaik a helyi háborúk során
- 16<sup>00</sup> **PADÁNYI, József:** Engineer Support to SFOR Air Operations
- 16<sup>15</sup> **SZEKERES, József:** A túlélés, mint a légierő művelettámogatás része

### **Aircraft Hydraulic & Power Systems**

**Chairman: ROHÁCS, József**

**Co-Chairman: PÁSZTOR, Endre**

- 15<sup>30</sup> **TŘETINA, Karel:** Dynamic Properties of Hydraulic Servocontrol System of Aircraft
- 15<sup>50</sup> **PÁSZTOR, Endre:** Turbinalapátok optimális hűtő levegő tömegáramának meghatározása
- 16<sup>10</sup> **STANCIU, Virgil—BOSCOIANU, Mircea:** Contributions to the Study of an Axial Compressor Stage by the Means of the Generalized Reaction Degree Concept

### **Automatic Landing Systems & Air Traffic Control**

**Chairman: PETÁK, György**

**Co-Chairman: LUDÁNYI, Lajos**

- 15<sup>30</sup> **DANCIK, Ján—HÝBL, Miroslav:** Automatic Landing System for UAV

- 15<sup>50</sup> **LUŽICA, Štefan:** Distortion Solution of the ILS Localizer Course Line by PC Support  
16<sup>10</sup> **SOMOSI, Vilmos:** Új alapelvek és eljárások a kecskeméti katonai közelkörzeti irányításban

#### **Flight Safety**

**Chairman: BENYÓ, György**  
**Co-Chairman: RUTTAI, László**

- 15<sup>30</sup> **SIKLÓSI, Zoltán:** The NATO Standard Safety Investigation Procedures, which should be Integrated into Home Regulations  
15<sup>50</sup> **DUDÁS, Zoltán:** A repülésbiztonság új értelmezése  
16<sup>10</sup> **RUTTAI, László—KRAJNC, Zoltán—DUDÁS, Zoltán:** A légtér feletti ellenőrzés képességének szintjei

#### **Reconnaissance & Communication Systems**

**Chairman: RÁDLI, Tibor**  
**Co-Chairman: SALLAI, József**

- 15<sup>30</sup> **SALLAI, József:** A rádióelektronikai felderítés potenciális adatforrásai jellemzőinek változása a vezetési- és fegyverirányítási rendszerekben  
15<sup>50</sup> **MARTON, Csaba:** Rádióelektronikai felderítés a békefenntartó műveletekben  
16<sup>10</sup> **SZÚCS, Péter:** Műholdas személyi kommunikációs rendszerek állóképessége a rádiófrekvenciás-, nagyfrekvenciás- és elektromágneses impulzus fegyverek ellen

#### **Helicopters**

**Chairman: POKORÁDI, László**  
**Co-Chairman: Miss AILER, Piroska**

- 15<sup>30</sup> **ROHÁCS, József:** Personal Air Transportation System – PATS Project  
15<sup>50</sup> **GRECMAN, Pavel:** Utilization of Self-protect Systems on Recent Helicopters Used by Czech Air Force  
16<sup>10</sup> **VARGA, Béla:** Noise Reduction Methods of Modern Single Rotor Helicopters

**16<sup>30</sup>—16<sup>50</sup> Coffee Break**

**16<sup>50</sup>—17<sup>50</sup> SESSION LECTURES II.**

#### **Multidisciplinary Sciences II.**

**Chairman: GALOVICZ, János**  
**Co-Chairman: BÉKÉSI, Bertold**

- 16<sup>50</sup> **KULCSÁR, Balázs—KORODY, Endre:** Pull-Up from a Dive  
17<sup>10</sup> **KOCSIS, Imre:** Forgó rendszer megbízhatósági elemzése  
17<sup>30</sup> **RÁTHY, Istvánné—BORDA, Jenő—HORVÁTH, Róbert—ZSUGA, Miklós:** Erősített műanyagok előállítása és vizsgálata

### **Military Education II.**

**Chairman: BÉKÉSI, László**

**Co-Chairman: JAKAB, László**

- 16<sup>50</sup> **BENYÓ, György:** A Légierő képzésének és továbbképzésének eddigi tapasztalatai és továbbfejlődés lehetőségei  
17<sup>10</sup> **JAKAB, László:** Experiences of Command Sergeant Major (CSM) Course in the Air Force  
17<sup>30</sup> **SIPOS, Jenő:** A ZMNE lehetséges helye a megalakuló Nemzetőrség kiképzésében

### **Aircraft Radar & Information Systems**

**Chairman: Mrs. VÁRKONYI, KÓCZY, Annamária**

**Co-Chairman: LUDÁNYI, Lajos**

- 16<sup>50</sup> **ANDRLE, Milos:** Using of the Data Output of the Modernized Precision Approach Radar for Aircraft Navigation  
17<sup>10</sup> **VOSECKÝ, Slavomír:** Integrated Fix Information  
17<sup>30</sup> **TKÁČ, Jozef—ŠPIRKO, Štefan—BOKA, Ladislav:** Radar Target Detection with Reduced Radar Cross Section

### **Maintenance of Technical Systems**

**Chairman: POKORÁDI, László**

**Co-Chairman: POROSZLAI, Ákos**

- 16<sup>50</sup> **POKORÁDI, László:** Fuzzy Logic-Based Maintenance Decision  
17<sup>10</sup> **OLEJNIK, Aleksander—KACHEL, Stanislaw—LESZCZYŃSKI, Piotr:** Recreation and Evaluation of the Aging Aircraft Structure for the need of Life-time Extension  
17<sup>30</sup> **HUSI, Géza:** Why I like the  $(ax^2 + b)/x$  function?

### **Military Leadership**

**Chairman: MRÁZ, István**

**Co-Chairman: PINTÉR, István**

- 16<sup>50</sup> **TÓTH, Sándor:** Values, Harmony, Social and Army  
17<sup>05</sup> **RÁSA, László:** Models of Changing Organisational Cultures Adequate to the Reorganisation of the Hungarian Defence  
17<sup>20</sup> **PINTÉR, István:** Levels of Leadership  
17<sup>35</sup> **BÁNYAI, Kornél:** Military Background and Leadership Skills in the Business Life

### **Fighter Evaluation**

**Chairman: SZABÓ, László**

**Co-Chairman: VARGA, Béla**

- 16<sup>50</sup> **PETÁK, György—BÉKÉSI, Bertold:** Gripen for Hungary. Why the Gripen is the Best Solution.

- 17<sup>10</sup> **ÓVÁRI, Gyula:** Csapásmérő repülőeszközök összehasonlító gazdaságossági-hatékonysági jellemzői kimunkálásának lehetőségei  
17<sup>30</sup> **ZALEWSKI, Piotr:** Selected Aspects of the Modern Fighters Evaluation

#### **Aircraft Engines**

**Chairman: ROHÁCS, József**  
**Co-Chairman: KAVAS, László**

- 16<sup>50</sup> **BOSCOIANU, Mircea—STANCIU, Virgil:** An Analysis of the Axial Flow Compressor Stability Using the Bifurcation Theory  
17<sup>10</sup> **Miss AILER, Piroška:** Kisteljesítményű gázturbina nemlineáris irányítása  
17<sup>30</sup> **ROTARU, Constantin:** Issues about Aircraft Turbojet Engines Control Laws

#### **Unmanned Aerial Vehicles**

**Chairman: SZABOLCSI, Róbert**  
**Co-Chairman: LUDVÍK, František**

- 16<sup>50</sup> **MAKULA, Petr:** Data Link Conception for Joint Tactical Unmanned Aerial Vehicles Based on STDMA Protocol  
17<sup>10</sup> **HAMMARBERG, Bengt—BERGLUND, Hans:** The SAAB NetDefense Concept  
17<sup>30</sup> **LUDVÍK, František—MARTIN, Šimaček:** Unmanned Air Vehicles – Critical Target

#### **Computer Aided Simulation and Design**

**Chairman: KURUTZ, Károly**  
**Co-Chairman: MARINESCU, Marin**

- 16<sup>50</sup> **MARINESCU, Marin—MATEI, Lucian:** Fuzzy Control of the Antilock Braking System of the Plane's Landing Gear  
17<sup>10</sup> **A. R. Varkonyi-Koczy — P. Baranyi — P. Michelberger:** HOSVD and LMI Based Methodology in Controlling Chaotic and Nonlinear Systems  
17<sup>30</sup> **BOJDA, Petr:** Algorithm Computing Electromagnetic Wave Scattering from Rough Surfaces

#### **Information Systems**

**Chairman: Klára Siposné, KECSKEMÉTHY**  
**Co-Chairman: TÓTH, Tivadar**

- 16<sup>50</sup> **FERENCZY, Gábor:** A protokollváltás szükségessége az Interneten  
17<sup>10</sup> **TÓTH, Tivadar:** Az Internet és a hadsereg PR  
17<sup>30</sup> **KRAJNC, Zoltán—BERKOVICS, Gábor:** A légielő szerepe az információs műveletekben

**PhD Student Session II.**  
**Chairman: RÁDLI, Tibor**  
**Co-Chairman: FEHÉR, András**

- 16<sup>50</sup> PAPP, Tamás—BUNKÓCZI, Sándor:** Korszerű rendszerek a légvédelem vezetésében  
**17<sup>10</sup> KALMÁR, István:** Korszerű légvédelmi rakétafegyverek zavarásának lehetőségei  
**17<sup>30</sup> SZŰCS, Endre—NOVÁK, Gábor:** A helikopterek alkalmazásának lehetőségei helységgharcban

**17<sup>50</sup>—18<sup>00</sup> Coffee Break**  
**18<sup>05</sup> CLOSING PLENARY SESSION**  
**Chairman: Klára Siposné, KECSKEMÉTHY**  
**Co-chairman: BEREK, Lajos**

- 18<sup>05</sup> ROHÁCS, József:** Nonlinear Problems in Critical Flight  
**18<sup>20</sup> SZABÓ, József:** A Magyar repülés kilencven évének képes története  
**18<sup>35</sup> ÓVÁRI, Gyula — Conference Closing Ceremony**





## **AVIATION EDUCATION ON MILITARY UNIVERSITY OF TECHNOLOGY, WARSAW**

### **INTRODUCTION**

The Military University of Technology (MUT) is the largest military polytechnic in Poland. The University has been shaped by the creative efforts of its excellent university teachers and research workers. In the University, the first lasers in Poland were designed in 1960; and then, pioneer work was conducted in respect of its military and civilian applications.

Nowadays, modern technologies are also being developed, especially those, which influence directly the methods of military equipment design and production and also those that contribute meaningfully to the advancement of science. The MUT currently conducting teaching and training in over 30 areas of technology at different levels: at the BSc level, MSc, postgraduate, and PhD level. The University is authorized to confer DSc degrees in 7 disciplines, and PhD in 9. Parallel to this, we conduct our own research work, which involves about 40% of the University's intellectual potential. In the light of participation in NATO and future accession to the European Community, MUT adapts its structure and functioning to the rapidly changing economy and educational challenges. Therefore, it is in process of transformation into modern, civilian-military university of technology.

### **FACULTY OF ARMAMENT AND AVIATION TECHNOLOGY**

The Faculty of Armament and Aviation Technology was established as a result of modernisation of Polish Armed Forces, mainly as a consequence of introducing of a military rocket technology in the late fifties. The faculty started its scientific and didactic activities in 1961 under the name of Faculty of Rocket Armament. Up to 1994 the name was changed twice. In 1990 the Institute of Aviation Technology was incorporated into the structure of the faculty. The institute was transferred from the Faculty of Mechanics. In 1994 the Faculty of Electromechanics was converted into a Faculty of Armament and Aviation Technology with a new structure. Now the faculty comprises:

- Institute of Aviation Technology;
- Institute of Rocket Technology;
- Institute of Armament Technology.

## AVIATION EDUCATION ON THE IAT

The Faculty of Armament and Aviation Technology (FAAT) of the MUT especially its Institute of Aviation Technology (IAT) is responsible for training of the ground (servicing) personnel for aviation of all military services i.e. Air Force, Navy and Army Aviation. The graduates of the MUT are in charge of maintenance and service all the fixed and rotary aircraft in operation of the Polish Armed Forces (PAF).

Due to fact that a modern aircraft, missile and rocket are very complex structures, since 1998 faculty has launched a new study domain called mechatronics. Simultaneously a new flexible model of study was introduced by all the university faculties (see Fig.1). The latter, as a result of adjustment of the MUT to civil standards.

**SCHEMATIC DIAGRAM OF EDUCATION PROCESS IN MECHATRONICS**

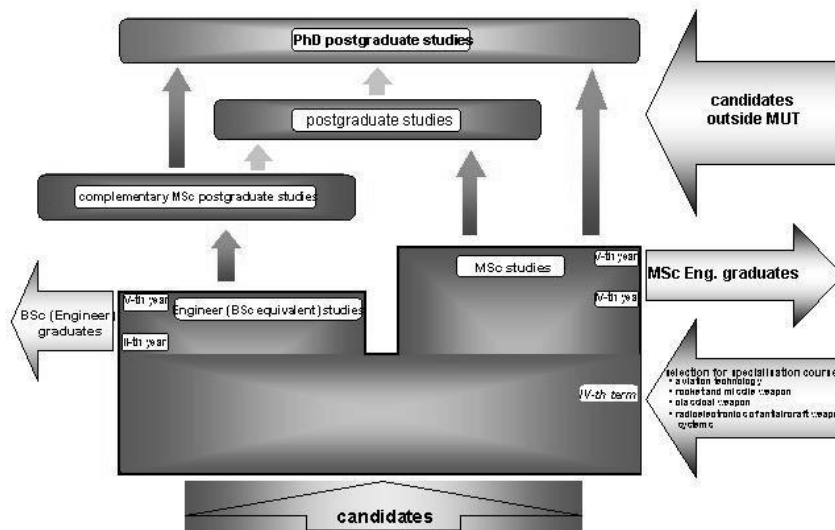

Fig.1. Flexible, three level model of study in the Military University of Technology

In consequence, new courses, including their curriculum were accepted by the Department of Defence and the Ministry of Education as well as international standards and requirements were met, such as: FEANI and ECTS. Nowadays, the Institute offers a three level flexible system of study in the field of aviation engineering: 4-year undergraduate program leading to a BSc degree, 5-year graduate program leading to the degree of a MSc as well as postgraduate program leading to PhD degree.

The essential feature of the present model of the university education is fact, that the first and second year of both undergraduate and graduate programs (provided by the faculty) are common independently from further specialisation and profiles (conducted subsequently by three institutes of the faculty). After completion of the second year of mechatronics, students who want to obtain aviation degree begin specialisation in aviation engineering and simultaneously a profile of the specialisation is selected. Recently following courses (called profiles) on aviation engineering are available at the Institute of Aviation Technology.

For cadets (military students) profiles:

- Airframe and Propulsion System;
- Aviation Armament;
- Avionics;

optionally for the PAF requirements the two following courses can be launched:

- Aircraft Emergency Escaping System;
- Navigation and Onboard Weapon Control System.

In the light of changes in country and due to fact that the MUT education system has got a full acceptance of Ministry of Education, university, including our faculty has been opened for civil students and some courses are available for them. Recently institute has launched part time and correspondence courses for civilian:

- Aviation Engineering (Airframe and Propulsion System, Avionics);
- Designing Manufacturing and Maintenance of the Mechatronics Systems.

However, the present names of profiles reflect the formers specialisation on mechanics and mechanical engineering lines (former lines of the faculty), their curriculum were deeply changed and fitted to a new requirement of modern aviation technology. We came up to a conclusion, that the modern aviation technology requires a new type engineer, who could be provided with substantial knowledge in the field of: mechanics, electronics, and informatics. Therefore the macro line mechatronics seems to be the satisfactory solution for our students, further maintenance managers or aviation designers. As a result of this assumption new subjects appeared in the mechatronics curricula, such as: marketing and organisation, systems theory, quality management, engineering graphics, CAD/CAM systems, mechatronics, microelectronics, diagnostics etc.

In that way CAD/CAM software and modern plotters replaced a conventional calculator and a drafting board. New courses, within mechatronics line, required not only modification of their curriculum but also modernisation of the laboratories and didactic stands. Almost all the classrooms were modernized, and new workshops were opened. One of the remarkable didactic laboratories is the aviation squadron (flight unit), military installation (an integrated part of institute), equipped with all aircraft in service of the PAF and logistic equipment, such as: hangar, apron, and ground auxiliary system. Aircraft and proper logistic base allow for on job training of students. Moreover, during the summer break our students spend a month at professional training in selected aviation companies, military aircraft works, military aviation units etc. Poland is a member of NATO treaty, satisfactory English language skill is one of the university objectives, so students complete 480 hours second level (according to STANAG 6001) English course.

## RESEARCH ON THE IAT

The academic staff carries out both fundamental and applied researches in mechanics, electronics, utilization and maintenance. The university personnel undertake research projects commissioned by both the Polish Armed Forces and military industry. The didactic and research base of the Institute is composed of 8 laboratories:

- Aerodynamics Laboratory;
- Aircraft Structure Laboratory;
- Thermodynamics Laboratory;
- Propulsion System Laboratory;
- Avionics Laboratory;
- Automatics Laboratory;
- Aviation Armament Laboratory;
- Aircraft Maintenance Laboratory

and mentioned above aviation squadron (flight unit) for on job training.

The laboratories are equipped with unique research stands and instruments, which enables performing measurements and experiments of several types in both laboratory and real conditions. Among many research and didactic installations worth specifying are:

- a subsonic wind tunnel of a 1.1 m in diameter measuring chamber with capabilities of reducing environment temperature up to minus 10 centigrade;
- a supersonic (3.5 Ma limited) wind tunnel of a 0.3 m in diameter measuring chamber;

- models of aircraft in service of the Polish Air Force for tunnel investigations:
  - a 1:20 scale model of the MiG-29;
  - a 1:25 scale model of the Su-22;
  - a 1:30 half model of the MiG-29;
  - a 1:1,25 model of a wing of the Su-22;
  - two models of a ejection seats in scale 1:2 and 1:3 respectively.
- three strength-testing machines;
- laboratory stands for the investigation of the thermal conductivity of insulating materials and the thermal diffusivity of solids, an interferometric dilatometer for a wide temperature range high thermal resolution investigations of the linear thermal expansivity of solids, a differential scanning calorimeter Pyris 1 (Perkin Elmer);
- a computer aided system of a guided missiles maintenance;
- a simulator of an on-board aircraft diagnostic system;
- 2-D and 3-D computer aided design systems (CAD) and a Unigraphics system for constructions modelling.

Nowadays the IAT employs 10 university professors (including 5 full professors), 18 doctors (with PhD degree) and 10 assistants. The Institute cooperates with civilian research centers. The Institute of Aviation Technology carries out researches in the following main domains:

- subsonic and transonic wind tunnel investigations of the aircraft elements;
- flying object moving investigations and the flight computer simulation for different type of flight disturbances;
- numerical calculations of a strength of aviation constructions in static and dynamic range;
- free vibration and flutter investigation for different aviation constructions;
- computer simulation investigations of flight control systems and on-board diagnostic systems;
- thermal-flow computations of aircraft engines and turbine power plants diagnostics;
- thermophysical properties investigations;
- studies on aircraft maintenance;
- studies on air-rocket systems and their optimum operation and maintenance;
- probability models of fatigue cracking expansion with implementation to the aircraft construction elements;
- identification of dynamics of mechatronics objects;
- evaluation of safety conditions for emergency ejection seats;
- gluing technology applied to the aircraft constructions;
- aircraft hydraulic systems and elements investigations;

- aircraft effectiveness evaluation of armament systems;
- design of a computer aided system of guided missile maintenance;
- on-board diagnostic system simulator design.

The Institute scientific and didactic staff is familiar with the latest achievement in the aviation technology. We take part in the world wide international aviation affairs (Farnborough International, Le Bourget Paris and ILA Berlin) and we actively participate in many respectable international congresses and seminars, such as: ICAS Congress, European Rotorcraft Forum and NATO-SCI/RTO. We participate in organisation of a few domestic and international conferences such as: „Avionics”, „Mechanics in Aviation” and „Science Aspect of Armament Technology”.



Fig. 2. The subsonic wind tunnel with capabilities of environment temperature reduction up to minus 10 centigrade.

#### REFERENCES

- [1] Military University of Technology, Warsaw <http://www.wat.waw.pl/>,
- [2] Faculty of Armament and Aviation Technology of the MUT <http://www.wul.wat.waw.pl/>

## **AUTOMATIC AIRCRAFT COLLISION AVOIDANCE SYSTEM FOR AIR COMBAT MANEUVERING**

Auto-ACAS is a joint US-Swedish program aiming at developing and flight testing an Automatic Aircraft Collision Avoidance System. This paper will present the Auto-ACAS system including a more detailed description of the algorithm.

The overall Auto-ACAS objectives are:

- Detect potential collisions.
- Activate and execute an avoidance maneuver at the latest possible instant.
- Nuisance free operation.
- Failure Safe Operation.

### **SYSTEM REQUIREMENTS**

The system consists of a data link for communication between the aircraft, the algorithm described below and the electric flight control system (EFCS), which is used for executing the avoidance maneuver. If the aircraft is already equipped with a data link no additional hardware is needed in which case the Auto-ACAS system can be implemented by software changes only.

### **CLAIM SPACE METHOD**

This Auto-ACAS algorithm does not try to identify collisions based on predicted probable trajectories of the aircraft. Instead it claims space along a predicted escape trajectory (time tagged positions were the aircraft will be after an avoidance is executed) which the aircraft will use in the case an avoidance maneuver is necessary. The major benefit of using an escape trajectory is that it can be predicted much more accurate than the probable trajectory which the aircraft will follow if no avoidance is executed. This is because the escape trajectory is executed in a predetermined way by the Auto-ACAS algorithm using the EFCS, whereas the probable trajectory is affected by the change in pilot commands. The size of the claimed space is computed using knowledge of



the wingspan, navigation uncertainty and accuracy of the predicted trajectory compared to the one the EFCS will make the aircraft follow if the escape command is given.

Each aircraft sends its predicted escape maneuver and the size of the claimed space along this track to the other aircraft, using the data link. All aircraft will use the escape maneuvers from the different aircraft to detect a future lack of escape, see Fig. 1. If the distance between the escape trajectories is greater than the safety distance, the track is stored as the one to use in case of avoidance. Else the avoidance is executed using the EFCS to make the aircraft follow the stored trajectory.

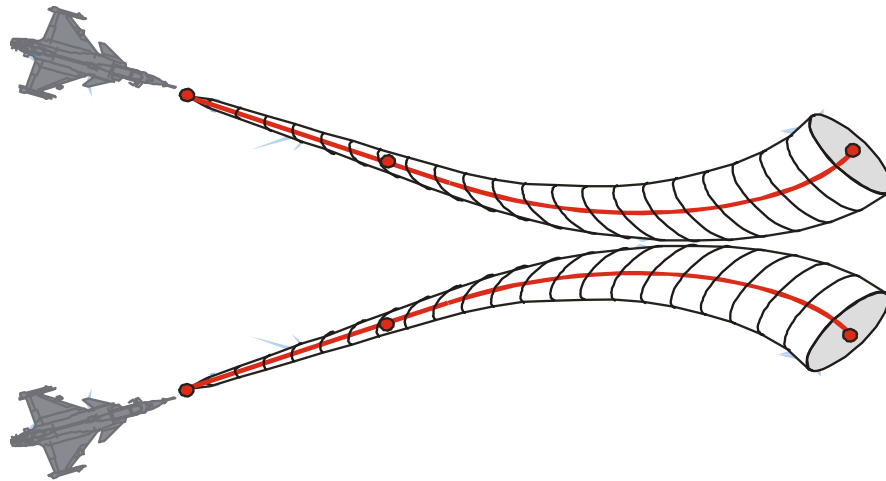

Fig. 1. Collision detection using predicted escape maneuvers

The escape maneuver directions are chosen to maximize the minimum distance between all aircraft. In this way the avoidance will be executed at the last possible instant and the system will thus guarantee a very low nuisance level.

## HANDLING OF TIME DELAYS

Due to the time delays (varies between 0.1 and 0.5 seconds) between the algorithms computed in the different aircraft the transmitted escape trajectory initially contains a 0.3 seconds predicted flight path after which the escape trajectory is added. As this prediction is done in the own aircraft current accelerations and angular velocities as well as velocities can be used in the prediction. To be able to compensate for the rest of the asynchronous delay the data contains the time when it was produced. The received data from the other

aircraft is dead reckoned to current time using transmitted velocity vector only. This means that no dead reckoning is needed if the actual time delay is 0.3 seconds between two Auto-ACAS algorithms. The data used for the own aircraft (own claimed space) in each iteration is chosen as the one having the closest timestamp to the other aircraft data used in that specific iteration. Thus time corresponding data is used in all aircraft which forces all algorithms to use the same data and thus executing the escape maneuvers at the same time.

## FAILURES AFFECTING THE ALGORITHM

Data dropouts, due to errors identified through parity check of the link data, “shadowing” or misalignment of the antennas etc., causes the established communication between two algorithms to disappear. To allow dropouts, even close to an activation, and still supply protection against collision the change of escape direction is limited as a function of actual distance and estimated time to activation. This limitation of change is balanced by the requirement that the escape maneuver shall be optimal and thus having the ability to change fast. At data dropouts the claimed space for the aircraft which the communication is lost for is also expanded in the own aircraft to handle unknown maneuvering and change of escape direction of the other aircraft.

Navigation degradation, due to loss/degradation of GPS, air data sensors, inertial navigation system or terrain navigation etc. is inherently handled by the algorithm. As the size of the claimed space is computed using the current navigation uncertainty a degradation of navigation performance only expands the claimed space according to the new uncertainty.

Failures in other sensor data, used in the computation of the predicted escape trajectory is handled dependent of how eminent the activation is. Close to an activation (collision) the latest computed own predicted escape trajectory is dead reckoned and the size of the claimed space is increased correspondingly for 4 seconds. After this time of normal collision detection the system goes to fail state. When no activation is eminent the system goes to fail state. Fail state also stops the sending of own messages over the link.

## SIMULATION RESULTS

The algorithm is currently implemented in c-code and integrated in non-linear 6 DOF equations software flight simulators. Two different environments are used ARES, Saab’s simulation environment both used in the company’s simulators and desktop workstations and D-SIX, a PC-based desktop simulator (product of Bihrl Applied Research. Inc).

The current implementation of the algorithm gives reliable, predictable results both in low and high dynamic scenarios. No nuisance is observed when aircraft are maneuvering outside the safety zones currently used in the Swedish Airforce and activations are performed in cases where collisions would be unavoidable. Further simulation results will be presented on the conference.

## CONCLUDING REMARKS

The approach to detect collisions by comparing predicted escape trajectories, previously applied in the implemented Ground Collision Avoidance System (GCAS), works well in avoiding other maneuvering aircraft. The optimization in the Claim Space method gives coordinated escape maneuvers at coordinated times.

The Auto-ACAS algorithm is generic in the sense that it can accommodate different aerial vehicles such as fighters, transports, tankers, UAV's etc. with a minimum of aircraft specific adaptation. Any aircraft that can predict its avoidance trajectory 5-10 seconds ahead and communicate that information via a data link can be protected with Auto-ACAS.

The algorithm will be integrated on two F16 during 2002 – 2003 and a flight demo phase in June – July 2003 will crown the current development of the algorithm.

Siposné Kecskeméthy Klára —Kormos László

## **REMARKS AND IDEAS ABOUT FUTURE AVIATION TECHNOLOGIES SYMPOSIUM AND MILITARY AIRCRAFT PERSONNEL TRAINING**

**MR. CHAIRMAN,  
LADIES AND GENTLEMEN,**

On behalf of the head of the Education and Science Department of Hungarian MoD I would like to welcome all participants of the Future Aviation Technologies Symposium, among those the representatives of foreign countries who are taking part first time in this workshop.

### **INTRODUCTION**

It's a good and progressive tradition at the Aviation Technical Institute (belonging to the Bolyai János Military Technical Faculty) in Szolnok, to organize Future Aviation Technologies Symposium yearly, on the occasion of the 12<sup>th</sup> of April, the Day of Astronauts.

The institution of the Future Aviation Technologies Symposium was established in 1991 by the section of Air Defense Department of the Hungarian Association of Military Sciences in Szolnok, and since then it has been held every year.

It's remarkable, that the Symposium has traditionally both military and civilian characters. Consequently we have a great opportunity to learn the result of both military and civilian research, to cooperate and to exchange experiences, - it is important for a small country's small Air Force and small defense university. It can be regarded progressive, supportable and sustainable. We need to underline that the Symposium provides a forum for young PhD students and other students who are interested in this field. The hard copy issued on the Symposium's material provides additional source to utilize the collected experience.

When we say the military and civilian character of the Symposium is to be sustained, we assume the further cooperation between the Szolnok Base (the education of the Air Force's personnel) and the Future Aviation Symposium in

the future. Interruption of this process would be harmful for the military specialist education, accordingly not advantageous for the Air Force, as well. I am very glad to highlight the international character of today's session because the presence of the foreign colleagues levels up the standard of this event and increases the quantity of experiences to be utilized.

## REMARKS ON EDUCATION OF THE MILITARY PERSONNEL

The education and training of military aircraft personnel seems to be the basis of the above-described relationship. The role of the educational facilities with the infrastructure – study rooms, laboratories and hangars – is important, however, training can be carried out either onto the Zrínyi Miklós Defense University's base or onto the Air Force's facilities, depending on the need of the Air Force. By the way, the education of military aircraft personnel is impossible to provide without an appropriate base for training.

When we are talking about the military aircraft personnel, or generally, about the training of officers and NCO's, we must not forget about some factors influencing the whole concept of training; such as, reform of the armed forces, reform of the military higher education, the current structure of the Hungarian Air Force, the officer/NCO ratio, the combat and technical conditions of the armament of the mentioned branch of Hungarian Defense Forces, the NATO membership requirements and so on.

During the last decade the topic of air Force's personnel training was focused several times. Due to it, this topic was discussed at the meeting of the Air Force's Staff, of the General Staff and of the MoD College, as well.

The related Air Force staff-officials have stated, it was a great mistake to integrate into the National Defense University the Air Force College in Szolnok. The reform of the armed forces, the concept and the direction, — represented by the higher echelon of the MoD — proved to be right in the last 10 years. Accordingly the new military educational system, based on one unified training base, has been able to provide an overall human resource for the Hungarian Armed Forces after the year of 2000. Nowadays this concept might be modified toward to develop new a way of military education within or outside the Zrínyi Miklós National Defense University.

When we are talking about the factors, influencing the concept of military education the relationship between the reform of the armed forces and the reform of the military educational system is expedient to underline.

There was an overall concept of strategic overview of the entire national defense system of the Hungarian Republic, issued in 1999 in form of a resolution of the Hungarian Government (No. 2322/1999.) Despite the later amendments the essence of the resolution has remained unchanged, that is as a result of the new structure of the defense forces, the organizations should work more economically, the implementation should cause significant reduction of the personnel, it continuously provides successful execution of actual tasks, it should modernize the secondary and higher military educational system and provide specialists with military skills and knowledge, training for civilian qualifications to outsource to the civilian educational system.

I think, the described resolution of the Government is clear-cut and we need to take it into consideration while sketching our concept for the future.

The Hungarian Government had discussed the situation of the Air Force before the issue of the previously described resolution. On its session held on the 7<sup>th</sup> of January, 1999 the Government acknowledged the project of the armed forces to provide the operability of the Air Force.

According to paragraph c/9 of this project the Education and Science Department of Hungarian MoD in cooperation with the General Staff and the Air Force's Headquarters had to work out a new concept for training of the aircraft personnel and other related specialists. The topic of the report — which had been ordered to forward until the 30<sup>th</sup> of April, 1999 — was “The concept for the education of air crews and the ground-based air traffic personnel in the years after 2000.” By some reasons the report remained “on the shelf” but main points of the report are still in power because they are related to the reform of armed forces and to the reform of the military educational system.

The topic of the report has been on a previous programme of the Future Aviation Symposium. Without getting engaged in repetitions, I would like to refer to some of the — today still relevant — points of the report mentioned above.

The most important thing is that after the year of 2000 the need for reinforcements for both the aircrew and ground-based personnel is going to decrease radically. Thus, it is necessary to consider the alternatives of possible solutions concerning the higher education of the different personnel categories. The other significant point is that one of the possible alternatives is the recruitment and employment of young civilians with civilian higher educational diplomas at the air-troops of the HDF's Air Force. The report mentions that after the year of 2000 need might arise for 5-7 persons per year for aircrew, air controller and aviation technician officers. Due to these small numbers enrolment seems to be reasonable every 2-3 years. In connection with the “civilian higher educational diploma + military post-graduate training” variant there is a view according to which this alternative is not usual in Hungary – at

least not at the same time and not with many participants involved. This alternative has not been realised yet. In NATO-member countries, it is an accredited model but the social acknowledgement of the national defence forces and officers is different there (obviously this acknowledgement also varies from one country to another). The essential condition for this type of recruitment is that the moral and financial acknowledgement of the career of an officer should be appealing that is in other words marketable for graduates of civilian colleges and universities.

Here I would like to refer back to the relation of the reform of the armed forces and the military higher education. On its 19 May, 2001 session, the board of the MoD taking the requirements and the effects of the reform of the armed forces into consideration discussed the proposition about “The Execution of the Integration of the Military Higher Educational Institutes and the Modernisation of the Military Higher Education”. The Defence Minister accepted the information, the plan and the schedule of the reform of the military higher education and took measures for a relating MoD order to be issued.

I would like to focus attention on two important factors of the concept.

- One of them is that as a consequence of the rate of the number of officers and non-commissioned officers (NCOs) determined by the reform of the armed forces the need for number of students in college basic training of officers is increasing. This need for the number of students is decreasing in the case of university basic training. The system of post-graduate and retraining courses that are the consequences of the special military needs of the MOD appears as a new element. This system does not require correspondence with the Higher Educational Law.
- The other element of the concept is that there is a need to examine more thoroughly than before the possibilities of the source of officer reinforcements. The possibilities for relieving the strains on the military higher education in order to free financial resources should be examined. Once freed, these financial resources could make the military higher education more economical, more rational and thus the costs of the officer training could be reduced. The recruitment and the subsequent military training of graduates of civilian higher educational institutes providing necessary training in lower officer ranks need to be institutionalised. (Now I advert to the findings of the 1999 report that pointed forward then and are still relevant today.) The freed financial resources should be used for providing stimulating possibilities that would make the transfer from the civilian sphere more advantageous.

The Szolnok campus of the Zrínyi Miklós National Defence University (NDU) fulfils its duties in aircraft personnel training well though not in full scale. We

should add that the Aeronautical Department and the Aviation Technical Institute in Szolnok are entitled to carry out aircraft personnel training under the authority of ZM NDU. At the Szolnok base, there is college basic training in the fields of mechanical and electrical engineering and military leadership. Although they are authorised, in the fields of military leadership, helicopter pilot and military aircraft pilot training has not been carried out for years.

I think; based on the previously discussed matters, it is obvious that all the aspects of training of military aeronautical specialists should be reconsidered. A significant step was taken forward, we can witness a pioneering initiative in military aircraft pilot training.

As a consequence of the termination of aircraft pilot training abroad, later in Hungary as well, several years are missing in the course of aircraft personnel training. This phenomenon has a negative impact on the age-rates of the aircraft personnel. At the same time in the forthcoming years the new type of aircraft will come into service the operation of which requires well-trained aviation personnel. The facts mentioned above established the need for the training of military aircraft personnel to be started. Economic analysis show that the conditions for aviation personnel training are not given in Hungary, thus training abroad comes into consideration. Based on the analyses and inspections we can state that it is suitable to take part in the aircraft personnel training provided by the Mutual NATO Aviation Personnel Training Programme in Canada.

The HDF, the HDF Air Force Headquarters (HQ) management plans to solve the problem of reinforcement of military aircraft pilots from the military and the civilian sphere (young people with civilian diplomas). The young aircraft pilot candidates recruited for flying personnel training from the civilian sphere will acquire the military and professional skills necessary for the fulfilment of their first officer assignment in the first phase of the training (the same as it has been with the course-type training of persons with civilian diplomas enrolled as military professional personnel).

What concerns the aeronautical engineering and air controller officer training, I would not like to engage in speculations. In connection with this it is sufficient to refer to the present situation. One of the main tasks mentioned in the task-part of the MoD order about the reform of the military education is the following:

“With regard to the needs of the HDF Air Force HQ, the study of the possibilities and variants of the execution of the officer and NCO professional training for the Air Force. Elaboration of adjoining proposals.”

The deadline for the execution of the present task will expire in the following days. The specialists of the MoD General Staff, HDF Air Force HQ, MoD ESD, MoD Planning and Co-ordination Department and the ZM NDU will take part in



its development. I think, by the execution of the above-mentioned task the next steps of the training of the military aircraft personnel will be clarified.

Arriving at the end of my presentation, finally, I'd like to emphasise, until Air Force exists as the branch of Hungarian Defence Forces, military aircraft personnel training will be necessary for a long period.

The recruitment of military aircraft personnel should be based on those professionals who graduated either at Miklós Zrínyi National Defence University, or come from civilian sphere, that is civilian higher educational institutes.

I think, the conclusion should be the following: Szolnok, with its developed infrastructure, must remain the main educational and training base for military aircraft personnel. Taking into consideration the above mentioned facts and following our progressive traditions, the Future Aviation Symposium can be organised here, in Szolnok next year again.

Finally, I wish successful work for the participants during the symposium. Thank you for attention.

## **INTEGRATED IMAGE INTELLIGENCE SYSTEM (I3S)**

The I3S concept (Integrated Image Intelligence System) represents an important step for autonomy in the IMINT (IMage INTelligence) field (obtaining information by aerospace imagery photointerpretation and analyses). An independent country should have the control of its own IMINT information source to manage and monitor the national and boundary territory.

This paper aims to present the I3S operational missions, the structure of a military intelligence center (MIC) and the I3S facilities for training and services.

### **INTRODUCTION**

The IMINT (IMage INTelligence) field means to obtain information using the photointerpretation and analysis of aerospace and terrestrial imagery.

The Integrated Image Intelligence System, named I3S according to the NATO standard, represents a major step to get autonomy and sovereignty in image information and intelligence. It is also a dedicated solution for military and civilian applications and represents an affordable solution for further evolutions. To be more efficient, the architecture of this concept it's build around three main subsystems (figure 1):

- aerospace vectors and ground reception stations for digital images processing and archiving;
- processing and analysis systems developed inside the exploitation centers;
- proficient image analysts for image photointerpretation.

### **I3S OPERATIONAL MISSIONS**

A feasible I3S system it's designed to carry out the following missions:

- political sovereignty: a sovereign state must control its own source of image information to master and monitor the situation inside and around its frontiers;
- military superiority: I3S provides high quality image intelligence for military decision making and mission planning through cartography, activity identification, tactical analysis, Digital Terrain Model, etc.;
- civilian missions: I3S provides an extensive source of data for any decision making process in Earth environment monitoring.

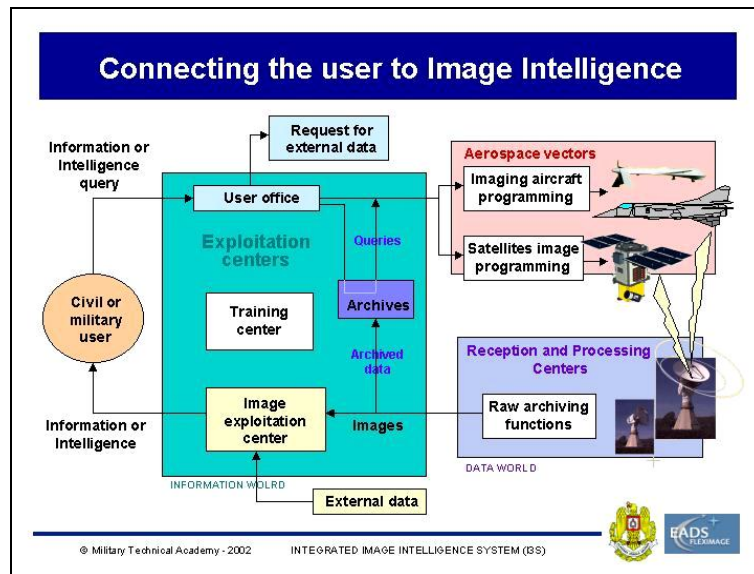

Figure 1: The I3S configuration

The table 1 presents a typical scenario solved by I3S methodology and finalized by an intelligence report:

Typical scenario for I3S military application Table 1.

<b>Authority</b> →	Defense Ministry / Rapid Action Force
<b>Purpose</b> →	Helicopter mission preparation on fresh data
<b>Needs</b> →	Limited area: 10×10 km <sup>2</sup> Mission rehearsal
<b>Delay</b> →	24 hours

To accomplish these needs we have to fulfill the following steps:

- mobile station deployment;
- satellite mission programming (sensor selection, reservation request, meteorological forecast,...);
- reception of technical data;
- image processing (geometric/radiometric, scenes geocoding, 3D data generation for flight simulation);
- image analysis (localization of known elements, change detection, search for new installations, activity detection);
- data transfer to the Mission Preparation Facility;
- action.

## OPERATIONAL PERFORMANCES

From operational point of view, figure 2 presents the data stream processed in I3S architecture (Raducanu, 2001):

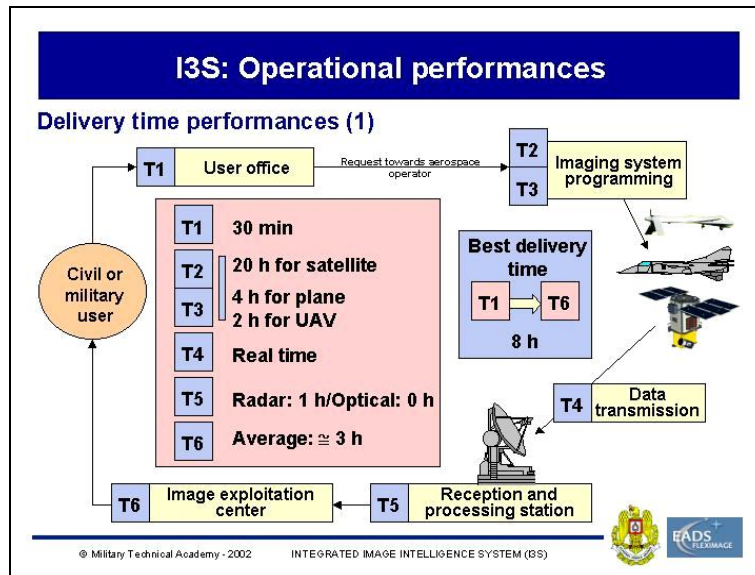

Figure 2: The data stream dynamics in I3S facility

Assuming that I3S is programmed to receive imagery from SPOT, RADARSAT, ERS, IKONOS and EROS satellite missions, the total capacity may reach 250 images/day. Two reception limitations have to be taken into account: the satellite availability (programming conflict in the area) and meteorological conditions (the total view time in the area of interest should be studied).

## THE MILITARY INTELLIGENCE CENTER

The I3S concept becomes a reliable activity only integrated in a Military Intelligence Center (MIC) structure. MIC represents the solution for national defense and security applications.

Thus, in peacetime MIC will monitor the border zone situation and perform surveillance of potential crisis spots. In crisis anticipation time MIC will accomplish close surveillance of areas of interest and gather technical

information. Finally, in crisis time MIC will perform mission planning, search and rescue activities and battle damage assessment (Blondelle, 2001).

Connected to a reception station, MIC offers a wide variety of technical functions, enabled by a dedicated software/hardware configuration (figure 3):

- extraction of IMINT from source data through image analysis process;
- cartographic products elaboration (2D, 3D);
- building of intelligence reports;
- training;
- storage and retrieval of intelligence data in high performance geographical databases.

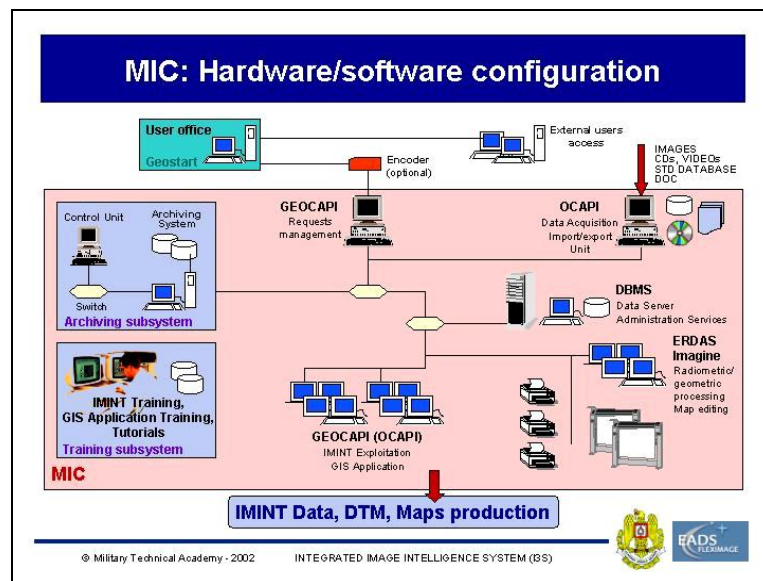

Figure 3: The typical MIC software/hardware configuration

## CONCLUSIONS

The satellite is the only reconnaissance tool, which has the capability to supply, in a discrete way, detailed images of a certain area from the Earth surface. At the beginning of the space era, the satellite was considered an inadmissible spying instrument, but very quickly was demonstrated its legality in information acquisition activity for peace and global security promotion.

The I3S concept offers new opportunities in this field, together with the classical information sources. Besides the very high panchromatic and multispectral resolution, which close the satellite imagery to the aerial one, we add all thematic

processing resources supplied by I3S. These inner advantages are completed by the system operation mode, which enable a rapid access to a certain zone and information updating by multitemporal analyses performed by photointerpretation experts.

#### **REFERENCES**

- [1] BLONDELLE, A.: Contribution of Satellite Imagery to Decision-Making Aid, Aerospace imagery analysis for military operators course (NATO IRI COMPLIANT), Bucharest, 2001.
- [2] RADUCANU, D.: Military and Cartographic Evaluation of Ikonos Imagery, Aerospace imagery analysis for military operators course (NATO IRI COMPLIANT), Bucharest, 2001.



Mráz István

## LEADERSHIP QUALITIES ON THE BATTLEFIELDS OF THE FUTURE

In my opinion the topic of the present symposium is very up to date in terms of the current technical development. Education should be based on the knowledge of the future. But we all live in a very special organisation the military. Our mission is combat, and the international experiences showed us some important aspects of the battlefields. There is more than one side to the coin. On the battlefield of course one is technical quality, level on high technology, but the other is human factor.

In the last century we learnt that we are far from the first line of fight now it became history. The battlefield of the future is predicted to be of enormous destruction. Resulting in great confusion and high level of fear among all those involved. In Yugoslavia we could see conventional weapons becoming far more lethal. It is especially valid to Afghanistan. The threat of NBC warfare can not be ignored even in Central Europe. And we don't have enough time to discuss the new military capacity of the electronic warfare.

Even attempting to communicate may result destruction from weapons systems that lock onto radio signals. Because of night fighting capabilities, soldiers may be called upon to fight continuously with little or no rest. They must to work day to night and night to day. An understanding of these key characteristics is critical for current and future planning.

Do not forget We must fight. Our work is not simply technical stuff. People who fight in the future wars may experience so much strain that they might break up before they come into contact with the enemy. If we analyse our future problems we must do it from the human perspective.

Now we will review in brief the effects of extreme status of arousal on human performance and then suggest ways in which the disruptive effects at arousal can be managed. I'd like to show you some stress factors of the future:

Future battles will be longer with slower replacement and greater potential for the combatants to feel that this could go on and on.

Objective danger will be higher because the extended size of the battlefields and airfields.

It will be impossible to run away from battle because it will not be clear in which direction safety lies nor will the person be able to avoid extended exposure while trying to locate that area.



The quantity of airborne metal will be greater, as will its destructiveness. Equipment will be more difficult to operate, less reliable, harder to repair, and there will be fewer replacement items because each item will cost more and therefore fewer will be purchased.

Units in future wars will be smaller, dispersed over wider areas, and connected by communication devices that are vulnerable to jamming. This will make it difficult for soldiers to get social support and an accurate view of what is happening.

It is necessary to wear uncomfortable masks, body armour, and clothes to reduce exposure to gas and radiation.

The most of the combatants will be enclosed in mobile vehicles for long periods with minimal visual access to what is going on outside.

Fighting will be continuous, which means that people will be exposed to danger for all duration and therefore must constantly be vigilant.

Since expensive, complex equipment will be continuously used, there will be a higher probability that it will break down, as a result exposing people to enemy fire with reduced protection.

Since ammunition will inflict more severe body damage, injuries will be less survivable even if people are evacuated.

These data incorporate the key processes I would like to highlight. I think it has been proven in human sciences why danger has such a pronounced effect on human efforts to operate weapons ( e.g., people could be more distracted, forget some steps, notice fewer potential problems, freeze, revert to old habits that are dysfunctional, become more cautious or more careless, overreact to misleading signals, etc.).

It is important to realise that the threats to performance implicit in states of extreme stress will affect maintenance personnel as well as combatants. Maintenance personnel are likely to operate under pressure because repairs are complex, more difficult to do; therefore, more things can go wrong. (For example, the maintenance manual for the F—14 fighter is over 300 000 pages). Furthermore, since there are fewer high-priced weapons in the inventory, all of them must be kept in constant service to sustain necessary force. To this situation add the reality that maintenance personnel have lower test scores, fewer processing skills, less complete on-the-job training, and fewer analytic skills than previously, and you are given a situation where baffled and agitated maintenance people have to repair the few pieces of hardware that the military could afford to buy.

If we ask the question: “Do formulators of technical guides, teachers and professors understand just how few resources they may have available in the field?” assessment of their writing and delivering is not reassuring. To “fight and win against a new attacker,” forces will need to exhibit greater skill, more

agility, and have a greater ability to co-ordinate different arms. The very things that planners are counting on — greater skill, more agility, greater co-ordination — are the very processes most likely to unravel under conditions of extreme arousal. This suggests that one of the fundamental assumptions that we have made about our future leaders' fighting ability may in fact be anchored more in wishful thinking than in fact.

Remember! In the new armies -unlike in the past- the officers are mangers, leaders, commanders in the same time, not simply technical executives.

## THE FUTURE LEADER MUST POSSESS

- *A frame of reference* that produces understanding of the dynamics of the rule system, how to modify or adjust the system to meet situational challenge, and how to operate within the system to produce previously untried solutions to situational challenge. This must be accompanied by a mind-set capable of constantly re-examining the logic of current alternatives and their current formulations according to the real situation.
- *More initiative and foresight*, especially at more junior levels, than at present. Leaders must be more sophisticated and, in all likelihood, less sensitive to the implications of rank differentials. (At present, all military persons are highly sensitive to their own rank and the rank of others around them.) This sensitivity may need to decrease in order to permit effective assumption of command at key times on the chaotic battlefield now visualized. Interestingly most of the subjective impressions show that even now the Army culture is moving toward decreased sensitivity to rank differentials. If that impression is correct, it is probably because of the increased technical competence now required at all levels and the increasing reliance on information to meet technical challenge. This represents a shift from concern about who is right to concern about what is right, which is strongly adaptive when viewed from the perspective of future requirements.
- *Higher technical competence at all levels*. Required technical skills are different from level to level, but technology is impacting to increase the demand for the expansion of such skills at all levels. (An interesting subordinate question is whether the trend toward increasing technical competence will conflict with the development of levels of unit cohesion needed in future combat.)
- *The capacity to generate higher levels of unit cohesion*, both lateral bonding and vertical bonding. Higher levels of cohesion will be needed

because of the higher levels of stress anticipated, but this cohesion will need to be developed in the peacetime Army. There will be no time to build it after hostilities begin.

- *The capacity to operate autonomously.* In addition to having the required thinking skills, leaders must also build respect and inculcate values in their units during peacetime which will serve as a basis for the maintenance of purpose and will by their units in combat, where it is probable that they will be separated from their senior leadership.
- *Greater flexibility and adaptability.* Because the future battlefield will almost certainly bring surprises (as previous ones have), leaders must have the capacity to recognise when a phenomenon is outside the existing taxonomy of phenomena and develop adaptations quickly. Units must also have the capacity to operate in expedient ways to meet the challenge of unanticipated events. Flexibility must be a unit norm, as well as an individual characteristic.
- *The capacity and opportunity to experiment* with unfamiliar situations in training, learn from mistakes, and overlearn the process of “thinking through” so as to ensure that the initial shock of combat stress will not cause “cognitive freezing.”
- *The capacity to create* a climate for more junior leaders that permits rational risk taking. This will need to be a climate in which training and development of subordinate leaders is viewed as a top priority, and coaching is viewed as both a method of choice and a required leader skill.
- *An awareness of power and politics*, which has historically been the prerogative of only the highest-level leaders.

It is clear that commanders are facing more complex challenges than ever before. They are forced to make decisions when no alternative seems to bring solution to the situation. Commanders rely on their subordinates at the greatest extent. Though making a hard decision is an outcome of teamwork, it is only the commander who bears the consequences in a very complex situation both by political and military means. Commanders must therefore prepare themselves to perform at a maximum in a very cautious way throughout the conflict and show enormous technical, professional and social skills.

#### REFERENCES

- [1] AR. 600-100. Army leadership.
- [2] FM. 22- 100. Military Leadership.
- [3] FM. 22- 103 Leadership and Command at Senior Levels.
- [4] Hunt and Blair: Leadership on the future battlefield. Pergamon- Brassey's, 1985.

## **DESIGN OF THE CHEBYSHEV BR FILTER FOR THE ELASTIC AIRCRAFT LONGITUDINAL STABILITY AUGMENTATION SYSTEM**

### **ABSTRACT**

In classical automatic flight control system's theory aircraft is considered as the rigid-body one. The controller automatically stabilizing the aircraft spatial motion is designed for the nominal plant. In real flight aircraft behaves elastically. Any external force or moment results in the aircraft elastic motion. The most common mathematical representation of the fuselage bending motion is the transfer function method. If to consider the aircraft elevator angular deflection for the input and the pitch rate as the output the model of the elastic motion can be considered as additive uncertainty. The purpose of the authors is to design a filter for hypothetical aircraft pitch rate gyroscope. For the solution of this problem a new MATLAB<sup>®</sup> M-file was created by the authors.

### **INTRODUCTION**

Due to their main features space and air vehicles are elastic ones. Airplanes are maneuvering in the three dimensional space and they must be considered as elastic vehicles. Aeroelasticity is in the focus of attention since many decades. Knowledge of the aircraft elastic motion is important for designers from the point of view of the sensor location upon the aircraft. If elastic motion results in the error of rate sensing it is necessary to filter electric signals of the sensors. Many aircraft flight control system is equipped with filters designed for filtering unwanted signals from the first and second elastic overtone [5]. One of the possible methods is the classical representation based upon the transfer function method. The most modern method for the elastic motion modeling is the state space representation, which allows to consider the aircraft as the multi input - multi output (MIMO) system. In this paper transfer function method is used for representation of the high frequency dynamics of the elastic aircraft.

## MATHEMATICAL MODEL OF THE ELASTIC AIRCRAFT

During the mathematical modeling of the elastic aircraft the fuselage and the wings elastic motion can be analyzed. The aircraft fuselage is considered as a simple rod. The fuselage bending motion equation is given in [2, 3, 6] to be:

$$\frac{d^2 q_i(t)}{dt^2} + 2\xi_i \omega_i \frac{dq_i}{dt} + \omega_i^2 q_i(t) = K_1 \delta_E(t) \quad (1)$$

where  $K_1$  is constant gain,  $\omega_i$  is the natural frequency of the undamped oscillation of the  $i$ th elastic mode,  $\xi_i$  is the damping ratio of the undamped oscillation of the  $i$ th elastic mode,  $q_i$  is the generalized coordinate of the  $i$ th elastic mode. Taking Laplace transform of eq. (1) respecting zero initial conditions we have:

$$(s^2 + 2\xi_i \omega_i s + \omega_i^2) q_i(s) = K_1 \delta_E(s) \quad (2)$$

It is easily can be seen that pitch rate generated by fuselage elastic motion can be determined as follows:

$$\omega_{z_E}(s) = \sum_{i=1}^{\infty} \frac{s K_i}{s^2 + 2\xi_i \omega_i s + \omega_i^2} \delta_E(s) \quad (3)$$

where  $K_i$  is the gain of the  $i$ th elastic degree of freedom. In [4, 5, 6] parameters of the 1<sup>st</sup> and the 2<sup>nd</sup> overtones of the hypothetical fighter fuselage bending motion are given as follows:

$$K_1 = 10 s^{-2}, \omega_1 = 10 s^{-1}, \xi_1 = 0,05; K_2 = 5 s^{-2}, \omega_2 = 20 s^{-1}, \xi_2 = 0,02 \quad (4)$$

Later it will be supposed that the longitudinal motion control system is affecting only the short period motion. The simplified mathematical model of the longitudinal motion of the aircraft is given by the following equation [1, 6, 7]:

$$\omega_{z_R}(s) = - \frac{A(1+sT_\theta)\omega_\alpha^2}{s^2 + 2s\xi_\alpha\omega_\alpha + \omega_\alpha^2} \delta_E(s) \quad (5)$$

In eq. (5) for the flight conditions H=1000 m and M=0.4 let us consider the following parameters of the aircraft [5, 6]:

$$A = 1,5 s^{-1}; T_{\theta} = 2 s; \omega_{\alpha} = 5 s^{-1}; \xi_{\alpha} = 0,5 \quad (6)$$

The output signal of the pitch rate gyro can be determined as sum of the rigid and elastic aircraft output signals defined by eqs (3) and (5):

$$\omega_z(s) = \omega_{Z_E}(s) + \omega_{Z_R}(s) \quad (7)$$

The aeroelastic aircraft model built by eqs. (3), (5) and (7) is represented in Figure 1.

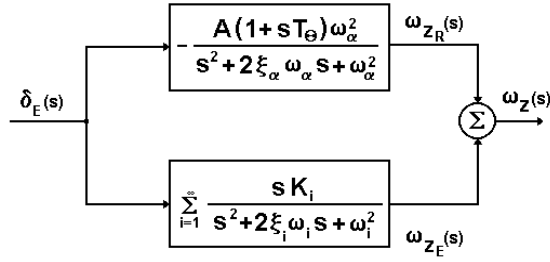

Fig. 1. The Aircraft Rigid Model and Elastic Model

Sign ‘-’ in rigid aircraft transfer function is for direction measuring between elevator deflection and the pitch rate. Elevator deflection is supposed to be positive if leads to negative pitch rate. If to neglect this sign in pitch rate damper the feedback must be positive.

## TIME DOMAIN ANALYSIS OF THE UNCONTROLLED AIRCRAFT

Let us consider the aircraft model defined by eq (5) and (6). Eigenvalues and dynamic performances of the aircraft are as follows:

$$\lambda_{1,2} = -2,5 \pm 4,33i, \xi = 0,5, \omega = 5 rad / s \quad (8)$$

The uncontrolled rigid and the uncontrolled elastic aircraft was analyzed in the time domain. Result of the computer simulation can be seen in Figure 2. From Figure 2 it can be seen that the uncontrolled aircraft transient response has large overshoot and response time. If the plant model is perturbed with elastic motion overstones given by eq. (4) the step response of the uncontrolled aircraft is highly oscillatory one. Pitch rate oscillates around step response of the rigid aircraft.

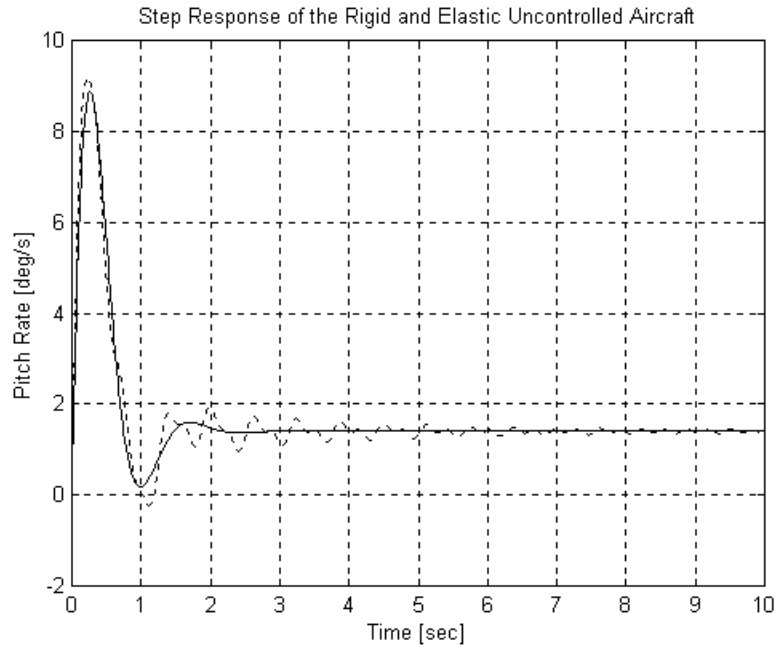

Fig. 2. Pitch Rate Step Responses  
 solid: uncontrolled rigid aircraft      dash: uncontrolled elastic aircraft

## FREQUENCY DOMAIN ANALYSIS OF THE UNCONTROLLED AIRCRAFT

Bode diagram of the additive uncertainty represented by the high frequency dynamics of the aircraft elastic motion can be seen in Figure 3. Uncertainty gain has resonance peak at  $10 \text{ s}^{-1}$  and at  $20 \text{ s}^{-1}$ . These peaks are developed by the D-lag in the numerator of eq. (3). Both in low and high frequency domain uncertainty gain is small.

The additive uncertainty affects the frequency domain behavior of the open loop stability augmentation system. Results of the computer simulation can be seen in Figure 4. During computer simulation unity gains for the controller and the pitch rate gyro were supposed.

From Figure 4 can be seen the effect from elastic motion dynamics, which can be considered for additive uncertainty. At the resonance frequencies of  $10 \text{ s}^{-1}$  and  $20 \text{ s}^{-1}$  the gain and the phase angle have peaks in their values. The open loop gain and the phase angle are increased only at the resonance frequency and in its nearest domain.

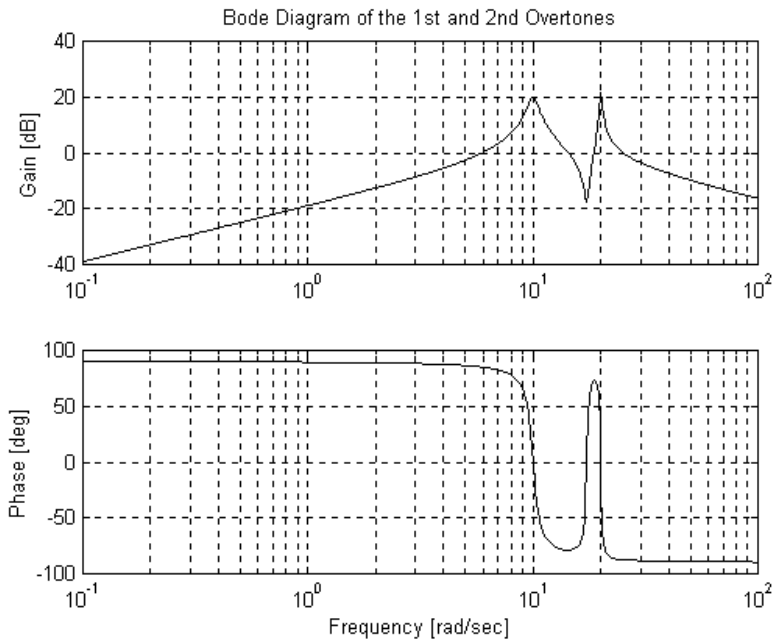

Fig. 3. Elastic Overtones Modeled as Additive Uncertainty

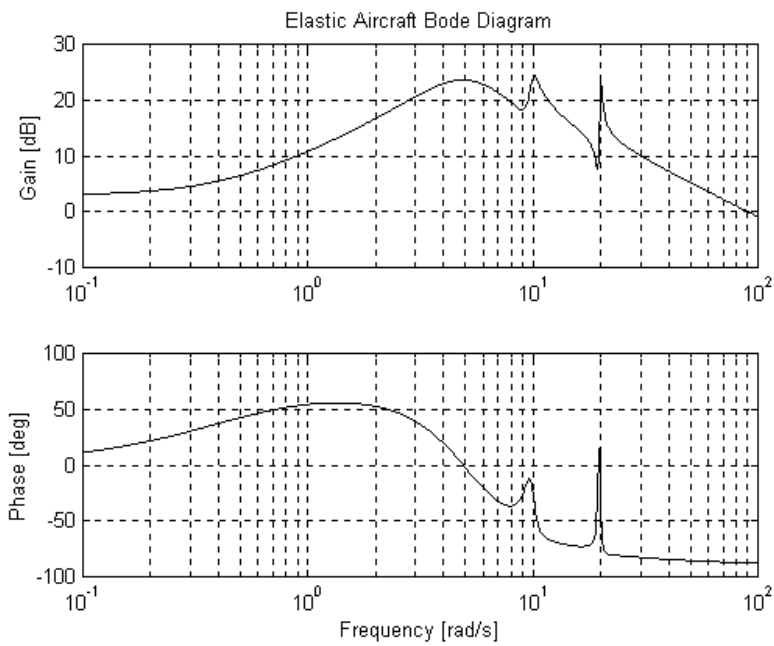

Fig. 4. Bode Diagram of the Open Loop Perturbed System



## BR FILTER DESIGN FOR PITCH RATE SENSOR

From Chapter “Mathematical Model of the Elastic Aircraft” it is evident that dynamics of the elastic motion of the aircraft fuselage is defined with the proportional-differential second order term (see eq. 3). For filtering of the output signals from pitch rate sensors there are some types of filter transfer functions given in [6] as follows:

$$Y_{F_1}(s) = \frac{(1 + sT_1)(1 + sT_2)}{(1 + sT_3)(1 + sT_4)} \quad (9)$$

$$Y_{F_2}(s) = \frac{s^2 + 2\xi_i\omega_i s + \omega_i^2}{s^2 + 2\xi_T\omega_i s + \omega_i^2} \quad (10)$$

Band rejection transfer function  $Y_{F_1}$  is for decreasing gain overshoots generated by elastic overtones. Filter design means finding appropriate time constants  $T_1, T_2, T_3$  and  $T_4$  for determining band rejection transfer function. The other possible transfer function is given by eq. (10). In this equation  $\xi_T$  is used as tuning parameter. From eq. (10) it is easily can be determined that for  $\xi_i \ll \xi_T$  takes place the following equation:

$$\left| Y_{F_2}(j\omega) \right|_{\omega=\omega_i} \ll 1; \left| Y_{F_2}(j\omega) \right|_{\omega \neq \omega_i} \approx 1 \quad (11)$$

Tuning parameter  $\xi_T$  must be found heuristically for determination of the filter transfer function. At the first stage filters were derived for resonance frequencies of  $10 \text{ s}^{-1}$  and  $20 \text{ s}^{-1}$ . Filters preliminary designed was tested and it was derived that transfer function given by eq. (10) provides not enough bandwidth for rejecting elastic motion gain overshoots. For increase of bandwidth of the band rejection filters for each overtone resonance frequency there was applied series connection of two filters adjusted for  $8,3 \text{ s}^{-1}$  and  $10,6 \text{ s}^{-1}$ . Transfer functions derived for these frequencies are:

$$Y_{11}(s)_{\omega=8,3} = \frac{s^2 + 2,65s + 68,89}{s^2 + 2,1s + 112,36}, Y_{12}(s)_{\omega=10,6} = \frac{s^2 + s + 112,36}{s^2 + 2,2s + 112,36} \quad (12)$$

The second overtone is rejected by series connection of filters adjusted for  $19,6 \text{ s}^{-1}$  and  $20,1 \text{ s}^{-1}$ . These transfer functions are:

$$Y_{21}(s)_{\omega=19,6} = \frac{s^2 + 2,6s + 384,16}{s^2 + 0,95s + 384,16}, Y_{22}(s)_{\omega=20,1} = \frac{s^2 + 2,6s + 384,16}{s^2 + 0,95s + 384,16} \quad (13)$$

Using eqs. (12) and (13) band rejection filters were tested in frequency domain. Results of the computer simulation can be seen in Figure 5.

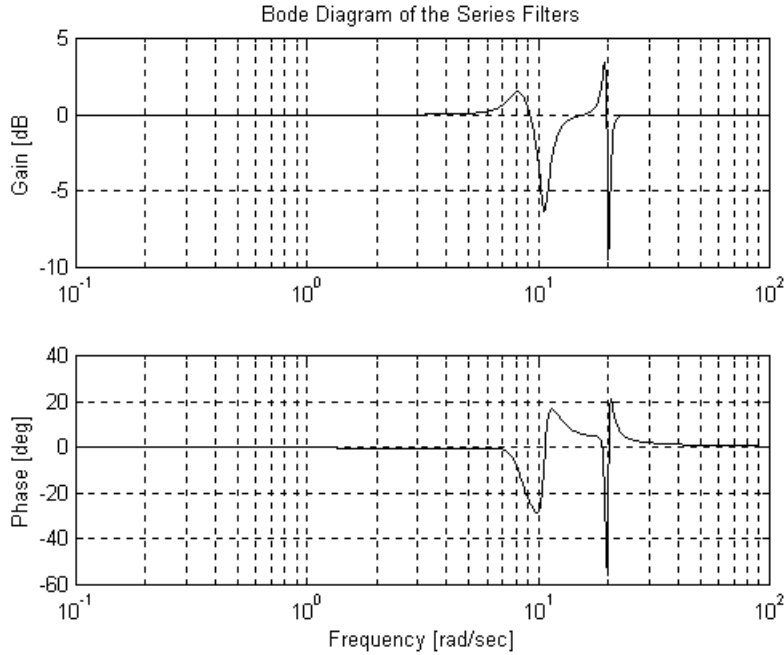

Fig. 5. Frequency Domain Behavior of the BR Filters

## TIME DOMAIN ANALYSIS OF THE AIRCRAFT LONGITUDINAL STABILITY AUGMENTATION SYSTEM

Dynamic performances of the controlled aircraft e.g. the damping ratio must be between 0,6 and 0,8 [7]. For providing desirable dynamic performances the pole placement method can be used. Pole placement is realized with state feedback by the pitch rate. The pitch rate damper is built using sensor, controller and hydraulic actuator. In conventional stability augmentation systems the pitch rate sensor is the electro-mechanical device. Sensor dynamics can be represented as the proportional second order lag. Assuming high natural frequency of the rate gyro it can be modeled as a simple proportional lag with unity gain  $K_s$ . The compensator is supposed to be proportional lag  $K_c$ . During analysis of the pitch rate it is supposed that hydraulic

actuator has fast response to input signals without any time delay. The block diagram of the longitudinal stability augmentation system when the first and the second overtone of the aircraft elastic motion are taken into account can be seen in Figure 6.

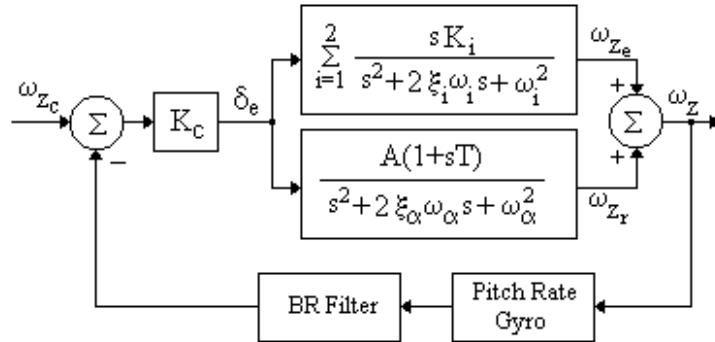

Fig. 6. Longitudinal Motion Stability Augmentation System

The longitudinal stability augmentation with the unity gain controller was analyzed in the time domain. Results of the computer simulation can be seen in Figure 7. From this figure it is easily can be stated that the rigid and the elastic aircraft behavior are very close to each other. For having appropriate time domain dynamic performances closed loop system must be adjusted varying controller gain  $K_c$ .

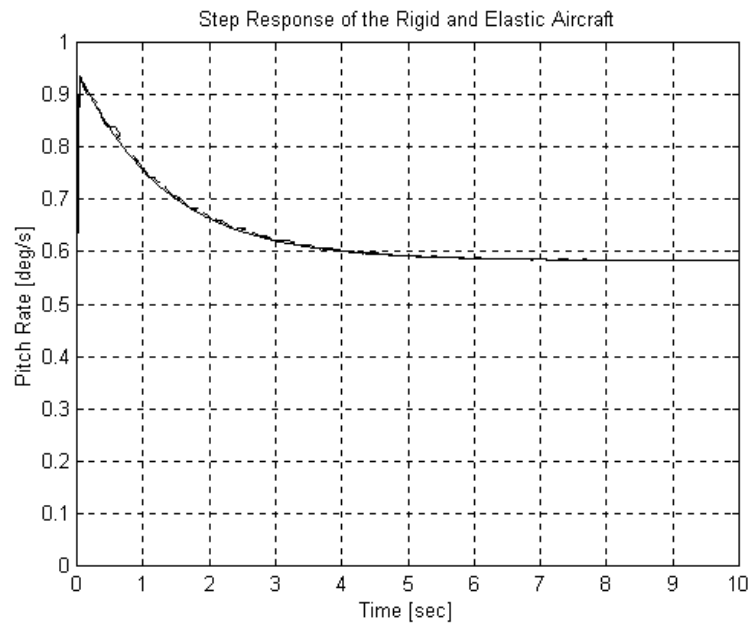

Fig. 7. Transient Behavior of the Aircraft

‘—’: rigid aircraft; ‘- -’: elastic aircraft; ‘...’: elastic aircraft with filter

## FREQUENCY DOMAIN ANALYSIS OF THE AIRCRAFT LONGITUDINAL STABILITY AUGMENTATION SYSTEM

In Chapter “Frequency Domain Analysis of the Uncontrolled Aircraft” Bode diagram of the elastic aircraft was shown. Applying filter given by eqs. (12) and (13) the open loop control system was analyzed in the frequency domain. Results of the computer simulation can be seen in Figure 8.

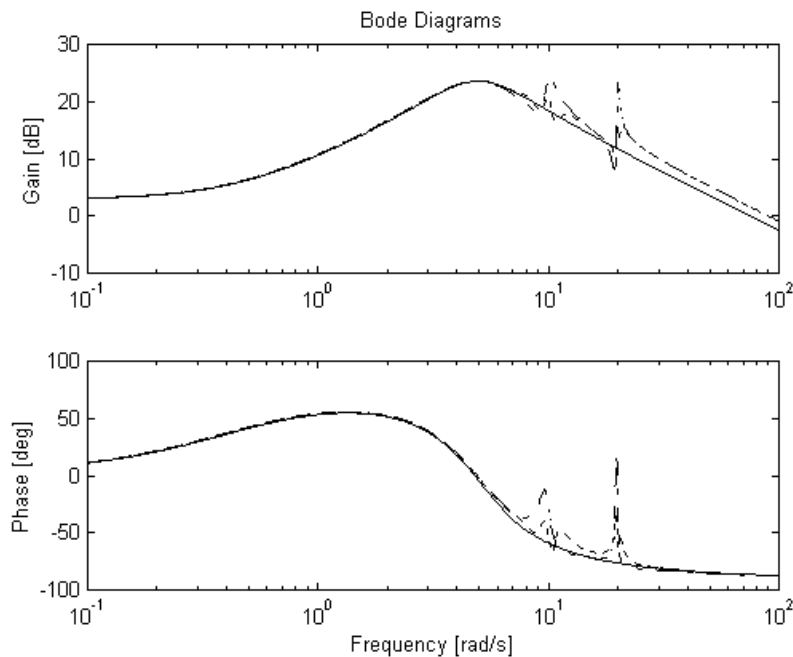

Fig. 8. Open Loop System Bode Diagrams

‘—’: rigid aircraft; ‘- -’: elastic aircraft; ‘...’: elastic aircraft with filter

From Figure 8 it is easily can be seen that filters adjusted for resonance frequencies of the first and second overtones of the aircraft decrease overshoots of the open loop gain. In frequency range beyond that of the second overtone there is some increase of the open loop gain. Overshoots in phase angle also decreased and there are deviations in it only at resonance frequencies.

## CONCLUSIONS

The paper deals with problems of mathematical modeling of aeroelastic aircraft and with problems of signal filtering of rate gyro output signal. The BR filters for elastic aircraft were designed for the hypothetical aircraft longitudinal stability augmentation system. Filters provide for the closed loop and for the open loop control system 'good' dynamic performances. For solution of the problem a new MATLAB<sup>®</sup> M-file was created by the authors.

### REFERENCES

- [1] Szabolcsi, R. Design of the Pitch Attitude Control System for the Aeroelastic Fighter Aircraft, *Bulletins for Applied Mathematics*, BAMB-1240/96, LXXX., pp. (29-40), Göd, Hungary, 10-13 October, 1996.
- [2] Bishplinghoff, R. L. - Ashley, H. *Principles of Aeroelasticity*, John Wiley & Sons, Inc., New York, London, 1962.
- [3] Krasovsky, A. A. et al. *Aircraft Automatic Flight Control Systems*, Joukowsky Military Academy, Moscow, 1986 (in Russian).
- [4] Szabolcsi, R. – Szegedi, P. Robustness Analysis of Control Systems, *Proceedings of the Pannonian Applied Mathematical Meetings PAMM, PC-136 Conference*, 24-27 January 2002 (in Print).
- [5] Szabolcsi, R. – Szegedi, P. Robustness Analysis of the Flight Stability Augmentation Systems, *Proceedings of the Pannonian Applied Mathematical Meetings PAMM, PC-136 Conference*, 24-27 January 2002 (in Print).
- [6] Aslanyan, E. A. *Automatic Flight Control Systems*, Air Force Institute, Kiev, 1984 (in Russian).
- [7] McLean, D. *Automatic Flight Control Systems*, Prentice-Hall, Inc., 1990.

## ACKNOWLEDGEMENTS

This research work has been supported by Széchenyi István Professorship of Ministry of Education under grant N<sup>o</sup> 175/2001, which is gratefully acknowledged by the authors.

## PRESSURE MICROTRADUCTORS AS DYNAMIC LINEAR SYSTEMS

### GENERAL INFORMATION

The sylphon is a revolution surface with thin walls, transversally curled on the lateral surface.



Fig. 1. Components with a sylphon, used in the construction of precision apparatus

The sylphon is literally a flexible element, but because of the partial little deformation, it is considered as an elastical element.

If it works under a focused target or as consequence of an interval pressure, the characteristic of a sylphon becomes linear (geometrically a line) between certain limits.

The inferior limits "A" borders above the opening of the gophers, and the above limit "B" borders below the area where the changing of the shape of the gophers begins.

Between “A” and “B” the distortion of the sylphon is in figure 2.

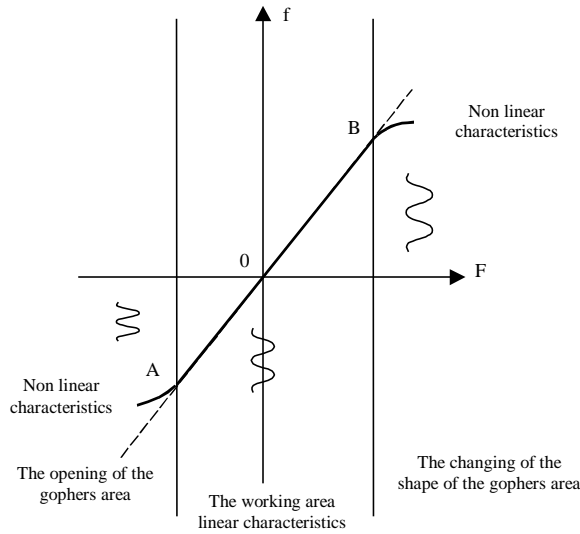

Fig. 2. The linear characteristics of the sylphon in the co-ordinate system  $F$  of, the abscissa  $OF$ -the variation of the force, the ordinate  $Of$ -the variation of the movement (of the sag)

When the component with a sylphon is used a traductor, the main issue is the determination of the mechanical rigidity or the construction of the metrological characteristics in static and dynamic regime. The stresses in the section of the sylphon must be within certain limits, not only for the sake of resistance, but especially because of the elastical hystheresis, literally because of the coming back to “zero” in the discharging status of the traductor.

## THE SYLPHON AS A DYNAMIC AND LINEAR SYSTEM

The sylphon may be considered as a dynamic system, which functionally controls the circuit of the fluid.

Intuitively, a dynamic system is conceived as a structure in which “a signal” can be introduced at a certain point and from which results-to the interior-“a signal” at another point, as in figure 3.

The concept of a system “ $\Sigma$ ” includes a set “ $T$ ” of associated torque of time.

In each torque  $t \in T \subset \Sigma$ , the system  $\Sigma$  receives an entrance signal  $u(t)$  and generated an exit sign  $y(t)$ .

We suppose that the values of the variable  $u(t)$  belong to a set of experimentally determined values  $U \subset u(t)$ .

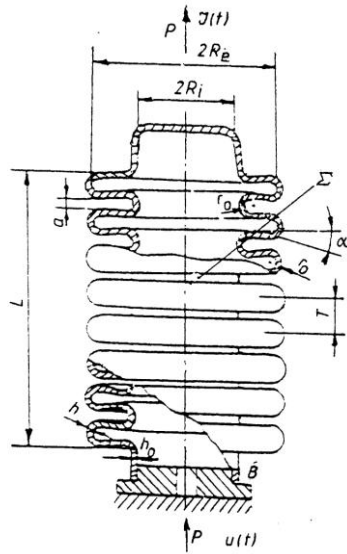

Fig. 3. The syphon as a dynamic system

The function  $\omega: [t_1, t_2] \rightarrow U$ ,  $\omega \in \Omega$  satisfies certain restrictions, the set  $\Omega$  is chosen because of mathematical and physical matters.

Every value of the exit signal  $y(t)$  is considered to belong to a determined set  $Y \subset y(t)$  and, generally, there are certain conditions that should be imposed, restrictions for exit functions  $\gamma: [t_2, t_3] \rightarrow y$ .

$y(t)$  doesn't depend only to  $u(t)$ , but also to the past status of the system  $\Sigma$ .

By the status of the  $\Sigma$  system a certain internal capacity of  $\omega: [t_1, t_2] \rightarrow U$ ,  $\omega \in \Omega$  (that is functional in the case of the traductor) is understood, at a certain point, that determines  $y(t)$  at the point and influences its future evolution. For instance: a minitraductor for the reduction or closure of the "too full" whole, a minitraductor to adjust the pressure of the air etc. In order to make the system a dynamic one it is necessary and enough that by knowing the status  $x(t_1)$  and the entrance function  $\omega: [t_1, t_2] \rightarrow U$ , then the status  $x(t_2) = \varphi(t_2, t_1, x(t_1), \omega)$  can be determined. From the experimentally point of view, the graphical characteristics "AOB" is linear.

From the mathematical point of view, it can be demonstrated that a dynamic  $\Sigma$  system is linear if:

- $X, U, \Omega, Y$  are vectorial spaces (over a given arbitrary body  $K$ ) where:  
 $X$  – a status set;  $U$  – the set of entrance values;  $\Omega = \{\omega/\omega: T \rightarrow U\}$  – a range of the entrance functions;  $Y$  – the set of the exit values;  $\Gamma = \{\gamma/\gamma: T \rightarrow Y\}$  – a range of the exit functions;  $T$  – the time set.



- $\varphi$  function:  $T \times T \times X \times \Omega \rightarrow X$  is a transition function whose value is the  $x(t) = \varphi(t, \tau, \dots, x, \omega)$  status, the status of the system at the  $t$  torque which depends on the initial  $x(\delta)$  status and the entrance variable  $\omega$ . The function  $\varphi(t, \delta, x, \omega): X \times \Omega \rightarrow X$  is  $K$  linear for any  $t \in T$ .
- The function  $\eta: T \times X \rightarrow y$  is the function, which determines the exit variable  $y(t) = \eta(t_1, x(t))$ . The function  $\eta: (t, \cdot) : X \rightarrow y$  is  $K$  linear for any  $t \in T$ .

After obtaining the solutions of the dynamic system and after choosing the physically coherent solution, it is necessary the approaching and, if possible, the solving of some objectives/goals as:

1. maximizing of the linear answering area, of the sylphon (the working area) under the action of an interval pressure (on concentrated force).
2. studying of the chosen stability solution, which consists of decisions upon the way in which disturbances from the entrance conditions of the sylphon reflects in the disturbances of the exit solution.
3. studying the extend in which the dynamic system considered is controllable and, therefore, adjustable.

For this experimental searching of the optimal entrance is pursued, which determines a certain status of the system or ensures a certain behavior of the exit, named in the work “the standard status” in order to compare with the working status.

## EXPERIMENTAL REZULTS

In order to accomplish the exposed conditions, theoretical studies have been made with practical finalizing like these:

1. The most indicated material was considered the bronze-beryllium alloy (Bz Be 2) which shows a steady linear characteristics up to  $p = 1,5 \text{ daN/mm}^2$  and  $t=150^\circ\text{C}$ ; little loss on the hystheresis (0,2-0,5%). At high pressures and cyclic stress bronze-beryllium and ads of titanium are used.
2. The sylphons used as very sensible elements can be combined with elicoidal arcs like in figure 4.

The advantage of those solutions lies in the reduction of the elastic hystheresis effect and the sensible growth of the working zone of linear characteristics.

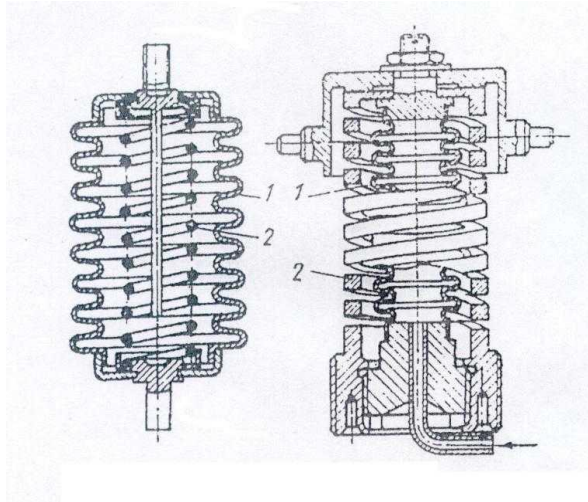

Fig.4. Sylphons combined with elicoidal arcs in the interior and exterior  
 1 – corrugated tube; 2 – exterior and interior elicoidal arcs

## CONCLUSIONS

- From the theoretical study and from the experimental results obtained results that the most indicated syphon from the point of view of the performances of the metrological characteristics for the goal is the one achieved from the alloy bronze-beryllium (Bz Be 2);
- The growth of the sensitivity of the traductor achieved based on this elastic element, and also of the working area can be obtained by introducing the component syphon-arc;
- The solution proposed has as an effect also reduction of the hystheresis of the traductor.

## REFERENCES

- [1] BATINETU Maria, LAMBADARIE Dan: System dynamic, Bucharest, 1993.
- [2] MOLDOVAN Elena: Achieving syphon tubes by plastic deformation. The 32<sup>nd</sup> International Scientific Symposium of the Defense Research Agency, Bucharest, 2001.
- [3] MOLDOVAN Elena, BOSCOIANU Mircea: The actual status of the achievement and use of the syphon tubes used for automatic systems of the aviation -The 32<sup>nd</sup> International Scientific Symposium of the Defense Research Agency, Bucharest, April 12-13, 2001.
- [4] \* \* \*: GOST 493-54. The materials used for corrugated tubes, Russian Federation.
- [5] \* \* \*: Internet – Aviation, corrugated tubes.



## **PRACTICAL AND PSYCHOLOGICAL ASPECTS OF THE TRAINING PROCESS FOR THE GUIDED BY THEIR ABILITIES HUNGARIAN MILITARY FORCES IN THE 21<sup>ST</sup> CENTURY**

The challenges of the 21<sup>st</sup> Century can be able to answer only that Hungarian military force which was renewed in his training levels and intellectuality and will be able to integrate into the Euro-Atlantic defence system accordance with the NATO's requirements. This process remarkably increases the importance of the training in the subordinate unit and this fact will support advantaged requirements with the subunit commander staff independent of their branch of military service. The success of the training's process will highly depend on the pedagogical and psychological skill's level of the subunit commander staff. The individual skill level and pressure of the exemplification have highly preferred role in the motivation system. This article should try to systematise the body of knowledge in this area and tries to take a few conclusions for the Hungarian force, in the first place some exact conclusions and helps for their practical using in the Hungarian Air Force's training system.

Nowdays, one cardinal element of changing the army is the qualitative change of the human resources. Every soldier independently of their ranks have to meet the professional requirements. The examination of being fit or unfit is coming into the limelight by the judgement of professional activity. The specialised literary sources on future wars deal with the influence of stress on the effective force. They try to explore the possibilities of adjusting to the situation as efficiently as possible. One important condition of the adjustment is the advanced state of the motorial abilities of the soldiers and their efficiency as a consequence. This topic is of high priority in the respect of preparing for fighting efficiently and after all tackling the war situation effectively.

Reorganisation of the military training by the new principles supports high requirements with the small unit commanders's pedagogical preparedness and assigns a part to them. Wanted aim of the military force reform should be a basically renewed Hungarian Army, based on the new training methods by the end of the reform. Only the high *fit to fight* level can be reached, because this level is the index of the combat success or unsuccess.

Service members exposed to danger experiences physical and emotional reactions that are not present under more tranquil circumstances. Some reactions sharpen abilities to survive and win; other reactions may produce disruptive behaviours and threaten individual and unit safety. These adverse behaviours are collectively called combat stress reaction. The operative word is behaviours. People in combat experience a range of emotions, but their behaviour influences immediate safety and mission success. Combat and combat-related missions can also impose combinations of heavy physical work; sleep loss; dehydration; poor nutrition; severe noise; vibration and blast; exposure to heat, cold or wetness, poor hygiene facilities and perhaps exposure to infectious diseases, toxic fumes or substances. These, in combination with other influences — such as concerns about problems back home — affect the ability to cope with the perception of danger, and diminish the skills needed to accomplish the mission. Environmental stressors often play an important part in causing the adverse or disruptive combat stress reaction behaviours. The leader must work to keep each member's perception of danger balanced by the sense that the unit has the means to prevail over it. The leader must keep himself and his unit working at the level of stress that sustains performance and confidence in themselves and their leader, adverse stress reactions are most likely to occur. It is important for the small-unit leader to recognise these adverse behaviours at the onset in order to intervene promptly for the safety and benefit of individual Service members and the unit. These behaviours may take many forms and can range from subtle to dramatic. Any Service member who shows persistent, progressive behaviour that deviates from his baseline behaviour may be demonstrating the early warning signs and symptoms of a combat stress reaction. Trying to memorise every possible sign and symptom is less useful to prompt diagnosis than keep simple rule in mind.: Know your troops, and be alert for any sudden, persistent or progressive change in their behaviour that threatens the functioning and safety of your unit.

## **OBSERVING AND RECOGNIZING COMMON REACTIONS TO COMBAT STRESS**

Ranges of fatigue, fear, anxiety and depression affect most service member in combat and in some military operations other than war. Mild stress reaction may be signalled by changes in behaviour and only be discernible by the person himself or by close comrades. The unit leader and medical personnel depend on information from the Service member or his comrades for early recognition of combat stress reactions to provide prompt and appropriate help. Table 1 lists some mild stress reactions.

Lists some mild stress reactions

Table 1.

PHYSICAL	EMOTIONAL
Trembling	Anxiety, indecisiveness
Jumpiness	Irritability, complaining
Cold sweats, dry mouth	Forgetfulness, inability to concentrate
Insomnia	Nightmares
Pounding heart	Easily startled by noise, movement and light
Dizziness	Tears crying
Nausea, vomiting	Anger, loss of confidence in self and unit
Fatigue	
“thousand-yard” stare	
Difficulty thinking, speaking and communicating	

Severe stress reactions may prevent the individual from performing his duties or create a concern for personal safety or the safety of others. A variety of more serious reactions or warning signs are listed in table 2. These do not necessarily mean that the person must be relieved from duty, but warrant immediate evaluation and help by the small-unit leader.

Variety of more serious reactions or warning signs

Table 2.

PHYSICAL	EMOTIONAL
Constantly moves around	Talks rapidly and/or inappropriately
Flinches or ducks at sudden sound and movement	Argumentative, acts recklessly
Shakes and trembles	Indifferent to danger
Cannot use part of body for no apparent physical reason	Memory loss
Inability to see, hear or feel	Stutters severely, mumbles or cannot speak at all
Is physically exhausted; cries	Insomnia; severe nightmares
Freezes under fire or totally immobile	Sees or hears things that do not exist
States vacantly, staggers or sways when standing	Has rapid emotional shifts
Panics, runs under fire	Socially withdrawn
	Apathetic
	Hysterical outbursts
	Frantic or strange behaviour

## STRESS-REDUCTION TECHNIQUES FOR LEADERS

To reduce stress, the leader should:

- Lead by inspiration, not fear or intimidation;
- Initiate and support stress management programs;
- Provide information to focus stress positively;
- Ensure each service member has mastered at least two stress coping (relaxation) techniques, a slow one for deep relaxation and a quick one for on the job.

Assure every effort is made to provide for the troops welfare  
Instil confidence in each service member and his equipment, unit and leadership.  
Be decisive and assertive; demonstrate competence and fair leadership.  
Provide sleep and/or rest, especially during continuous operations, whenever possible.  
Ensure sleep for decision making personnel.  
Set realistic goals for progressive development of the individual and team.  
Systematically test the achievement of these goals.  
Recognise that battle duration and intensity increase stress.  
Be aware of environmental stressors such as light level, temperature and precipitation.  
Recognise that individuals and units react differently to the same stress.  
Learn to signs of stress in yourself and others.  
Recognise that fear is a normal part of combat stress.  
Rest minor stress casualties briefly, keeping them with their unit.  
Be aware of background stress sources prior to combat.  
Provide an upward, downward and lateral information flow to minimise stress due to lack of communication.  
Practise stress control through cross-training, task allocation, tasks matching and task sharing.  
Look for stress signs and a decreased ability to tolerate stress.  
Practice and master stress-coping techniques.  
Face combat stress; it is unhealthy to deny the stresses of combat.

## PHYSICAL FITNESS

Good physical conditioning delays fatigue, builds confidence, and shortens recovery times from illness and injury. It also prepares individuals to better cope with the physiological demands of stress. Service members in top physical condition can better control their internal physiological functions, which will improve their overall performance. Physical fitness — including aerobic fitness, muscular strength and endurance — must be developed in all Service members to strengthen their ability to rebound from exhaustion. Aerobic fitness increases work capacity and the ability to withstand stress. While feelings of depression and moodiness accompany tiredness, aerobically fit Service members are affected less than those unfit. The ability to quickly recover from physically strenuous workloads is maintained by smart physical training, performed consistently and routinely. However, there is no evidence that good physical conditioning significantly reduces normal sleep requirements nor compensates for the deleterious impact of sleep deprivation on cognitive functioning.

## EFFECTIVE LEADERSHIP

The effective leader in combat is competent and reliable. He knows his job without question and he can be counted on to do it regardless of the situation or circumstances. Effective small-unit leadership reduces the impact of stress in several ways. Leaders understand the sources of combat stress and reactions to them. In addition, leaders manage stress problems to keep them from spreading throughout the organisation by implementing the following actions:

- Continue mission performance; focus on immediate mission.
- Expect service members to perform assigned duties.
- Remain calm, directive and in control at all times.
- Let service members know their reactions are normal and there is nothing seriously wrong with them.
- Keep service members productive (when not resting) through recreational activities, equipment maintenance and training to preserve perishable skills.
- Ensure service members maintain good personal hygiene.
- Ensure service members eat, drink and sleep as soon as possible.
- Let the service members express their thoughts. Do not ignore or make light of expressions of grief or worry. Give practical advice and put emotions into perspective.



## PHYSICAL CONDITIONING

A strong relationship exists between physical stamina and ability to resist combat stress. Good physical conditioning has physical and psychological benefits. Rigorous physical conditioning helps protect against the stress of continuous operations. A regular program of physical fitness to increase aerobic endurance, muscular strength and flexibility is essential to combat readiness. As physical conditioning improves, service members feel better about themselves, have greater confidence in each other and their stress is reduced.

Unit training includes regular physical conditioning. This increases the members' tolerance to all types of stressors. The program is geared to the unit's combat mission and exercises are tailored to the environment where the unit operates. The pace commensurate with the unit's need. Light infantry units need more demanding, longer road marches than maintenance units. Activities also include team athletics, which capitalise on cohesion-building aspects as well as physical benefits. The benefits of such a program include developing endurance through aerobic exercises, enhancing strength through weight training and deprivation/physical stress training.

## ENGINEER SUPPORT TO SFOR AIR OPERATIONS

### MISSION HISTORY

Implementation Force (IFOR) had a one-year mandate to oversee implementation of the military aspects of the peace agreement - separating the armed forces of Bosnia's two newly created entities, the Federation of Bosnia and Herzegovina and Republika Srpska; bringing about and maintaining an end to hostilities; transferring territory between the two entities according to the peace agreement; and moving the parties' forces and heavy weapons into approved storage sites. These goals were achieved by June 1996. As Stabilization Force (SFOR) succeeded IFOR at the end of 1996, the mission's aims became more ambitious. In addition to deterring a resumption of hostilities and promoting a climate in which the peace process could continue to move forward, they included providing an increased level of selective support, within SFOR's means and capabilities, to civilian organisations.

One of the most important part of the General Framework Agreement for Peace (GFAP) deals with freedom of movement in Bosnia and Herzegovina (BiH)<sup>1</sup>. In compliance with it, air and surface movements in BiH shall be governed by the following provisions:

The IFOR shall have complete and unimpeded freedom of movement by ground, air, and water throughout BiH. The IFOR Commander shall have sole authority to establish rules and procedures governing command and control of airspace over BiH to enable civilian air traffic and non-combat air activities by the military or civilian authorities in BiH, or if necessary to terminate civilian air traffic and non-combat air activities.

The Parties understand and agree there shall be no military air traffic, or non-military aircraft performing military missions, including reconnaissance or logistics, without the express permission of the IFOR Commander. The only military aircraft that may be authorized to fly in BiH are those being flown in support of the IFOR, except with the express permission of the IFOR. Any flight activities by military fixed-wing or helicopter aircraft within BiH without the express permission of the IFOR Commander are subject to military action by the IFOR, including the use of necessary force to ensure compliance.

---

<sup>1</sup> General Framework Agreement for Peace Annex 1-A Military Aspects of the Peace Settlement.

All air early warning, air defence, or fire control radars shall be shut down within 72 hours after this Annex enters into force, and shall remain inactive unless authorized by the IFOR Commander. Any use of air traffic, air early warning, air defence or fire control radars not authorized by the IFOR Commander shall constitute a breach of this Annex and the violating Party shall be subject to military action by the IFOR, including the use of necessary force to ensure compliance.

The Parties understand and agree that the IFOR Commander will implement the transfer to civilian control of air space over BiH to the appropriate institutions of BiH in a gradual fashion consistent with the objective of the IFOR to ensure smooth and safe operation of an air traffic system upon IFOR departure.

## MILITARY OPERATIONS

Support implementation of the GFAP and responding to the United Nations Security Council (UNSC), the North Atlantic Council (NAC) has authorised a NATO-led operation to deter a resumption of hostilities and continue to stabilise the peace in BiH. The NAC provides overall political direction and control. NATO's objectives are to:

- Contribute to the secure environment necessary for the consolidation of the peace;
- Continue to consolidate SFOR achievements and promote a climate in which the peace process can proceed;
- Promote a transition of emphasis from military to civil implementation;
- Ensure that the size, role and profile of the NATO-led military contribution is gradually reduced, on the basis of reviews of tasks, environment and risks as part of a Transition Strategy linked to the achievement of an end state;
- The desired NATO end state is a secure environment adequate for the continued consolidation of the peace without the further need for NATO-led military forces in BiH.

## KEY MILITARY TASKS

- Maintain a deterrent military presence in the country.
- Act to prevent major breaches of the cessation of hostilities or the removal of heavy weapons or air defence weapons from cantonment.
- Continue to operate Joint Military Commissions (JMC) at appropriate levels.
- Contribute, within means and capabilities, to a secure environment in which the international civil organisations and the parties to the GFAP can carry out their responsibilities under the agreement.

- Ensure force protection and own Freedom of Movement (FOM).
- Ensure continued compliance with the cease-fire and Zone Of Separation (ZOS) and other military aspects of the GFAP.
- Monitor, and if required, enforce compliance with the military aspects of the GFAP.
- Enforce rules and procedures governing the use of airspace over BiH in coordination with the BiH Department of Civil Aviation (DCA) with the understanding that the DCA has no power of veto over SFOR air operations.
- Control the airspace over BiH.

## KEY SUPPORTING TASKS WITHIN MEANS AND CAPABILITIES

- Provide, on a case-by-case basis, support to the High Representative (HR) in his role of implementing the civil aspects of the GFAP, as well as to the other principal civil organisations.
- Support the Supervisor in implementation of Brcko arbitration decisions presently in effect.
- Support the Office of the High Representative (OHR) and Organisation for Security and Co-operation in Europe (OSCE) in the conduct of elections and installation of elected officials.
- Support and promote phased and orderly returns of Displaced Persons and Refugees (DPRE) by contributing to a safe and secure environment in co-operation with the OHR, United Nations High Commissioner for Refugees (UNHCR) and other international organisations but not forcibly return them or undertake to guard individual locations.
- Support OHR and OSCE in media reform efforts, and support International Criminal Tribunal for the former Yugoslavia (ICTY) and efforts against Persons Indicted for War Crimes (PIFWCs).
- Provide, on a case-by-case basis, selective support to the OSCE, if requested, in implementing Annex 1B of the GFAP in BiH.
- Contribute to the continued improvement of FOM throughout BiH and Support the Standing Committee on Military Matters (SCMM).

## AIR OPERATIONS

Air operations in support of the GFAP provided by the Joint Force Air Component Commander for the following tasks:

- Airspace Management/Control and Surveillance in the Theatre Area of Operations (TAOO) to include enforcement of rules and procedures governing the use of BiH airspace.
- Air Policing to include the identification, interception, intervention and engagement of unidentified aircraft. Intervention and engagement will be specifically authorised in accordance with the Rules of Engagement (ROE) in force.
- Search and Rescue (SAR), as required, to support the SFOR and Combat SAR (CSAR) if required.
- Reconnaissance and surveillance to monitor compliance with the GFAP and for the security of the SFOR.
- Offensive Air Support (OAS), as required, in accordance with the ROE in force, to provide a robust capability to support and protect the SFOR in the event of a direct attack.
- Suppression of Enemy Air Defence (SEAD), as required, in accordance with the ROE in force, to counter Air Defence (AD) threats to the SFOR air operations.
- Air Transport/Medical Evacuation (MEDEVAC) as required, in support of the SFOR.

## ENGINEER SUPPORT

SFOR Engineers shall maintain and improve Theatre Controlled Routes (TCR), Main Supply Routes (MSR), Airports of Debarkation (APODs), Seaports of Debarkation (SPODs) and Railheads in order to ensure SFOR's FOM, and to provide the appropriate level of force mobility and sustainability as well as safety on those routes. Engineers on each level of command shall provide support to ensure FOM as defined necessary by their level of command.

## PRINCIPLES OF ENGINEER SUPPORT

The Troop Contributing Nations (TCN) of SFOR provide adequate Engineer support at each level of command, including brigade, division and theater. Engineer units provided by TCN to support a particular command, retain as their primary role the provision of military engineering support to that command. The following general principles apply.

## COORDINATION OF ENGINEER EFFORT

Engineer effort is coordinated at Theatre level and prioritized at all command levels. This may lead to engineer forces being tasked outside their own formation boundaries, by appropriate commanders.

## THEATRE LEVEL ENGINEER OPERATIONS

Theatre level engineer operations may take place anywhere within SFOR's Area of Responsibility (AOR); subject to coordination with CJ4 to ensure de-conflicting of movements and the commands responsible for that AOR. In particular the engineering projects eligible for funding by the NATO Security Investment Program (NSIP) are managed at Theatre level. The main theatre level projects are:

- Repair and maintenance of the TCRs and the MSRs.
- Snow and Ice Clearance (SNIC) on the TCRs and MSRs.
- Development of essential facilities at APOD and SPOD, to assist SFOR FOM into and out of theatre.

Ensure SFOR's possibility to use the national rail network on the main routes / in the main directions within BiH.

## ENGINEER ORGANIZATION

### a) Command Relationships of CJ ENG

The position of CJ ENG within the overall HQ SFOR staff structure is shown in figure 1 below:

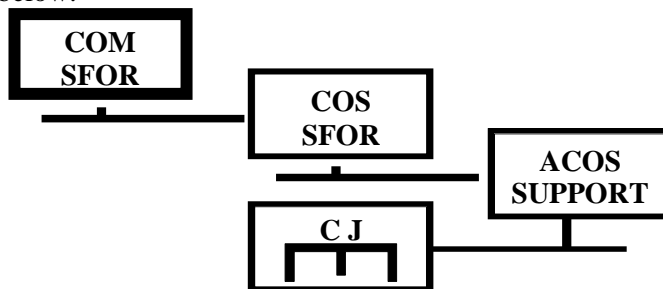

Fig. 1. Command Relationships of CJ ENG within HQ SFOR<sup>2</sup>

<sup>2</sup> CJ ENG— Combined Joint Engineers;  
HQ — Headquarters;

## b) Engineer Chain of Command

The Theatre Engineer Organization is shown in figure 2 below. Tasking of these units is done by CJ3 on recommendation of the Chief ENG. Theatre Engineers are also tasked by Task Orders of CJ ENG.

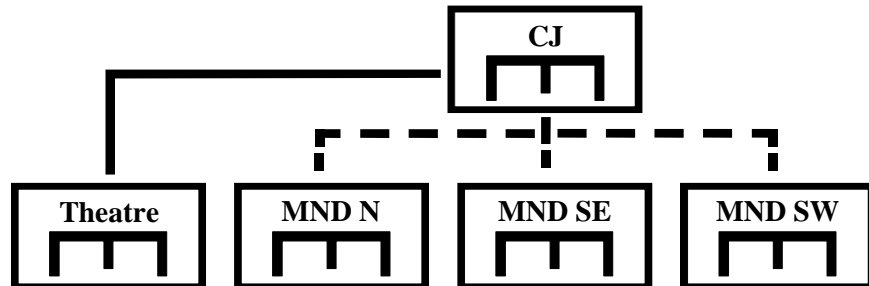

Fig. 2. SFOR Engineer Chain of Command<sup>3</sup>

## RESPONSIBILITIES

### Engineer Information and Intelligence

CJ ENG HQ SFOR is responsible for the dissemination of Theatre level engineer intelligence and information. Engineers on all levels are responsible for the collection and collation of engineer information and intelligence within their AOR. Engineers at all command levels are responsible for reporting and disseminating engineering information that has operational implications. There are specific requirements for which special reporting arrangements apply:

### Route Information

The Freedom of Movement Engineering Team (FOMET) is responsible for keeping MSR, TCR, APOD and SPOD operational, in order to ensure SFOR's FOM.

### Logistics, Engineer Material and Budgets

The following principles apply:

- a) Maintenance and Re-supply TCNs are responsible for conducting both maintenance and re-supply for their nationally owned equipment and engineer materiel.

---

COMSFOR — Commander of SFOR;  
COS — Chief of Staff;  
ACOS — Assistant Chief of Staff.

<sup>3</sup> Multinational Division

b) Local Procurement Local supply, purchase and delivery of materiel for the conduct of Theatre engineer tasks is managed by CJ ENG Logistics through the SFOR Theatre Area Contracting Office (TACO) organization.

Budgets Budgetary authority for undertaking engineer tasks is provided by NATO through SHAPE and SFOR CJ8 to the Chief Engineer SFOR. All funding requests will be coordinated through the SFOR Financial Controller and reviewed at the Financial Management Review Board (FMRB).

## SFOR ENGINEERING PROJECTS

Standard Operating Procedures (SOP) 7101 describes procedures which CJ ENG must execute for the life cycle of Engineer projects in theatre. This SOP provides detailed explanations and examples for project submission, allocation of funds, procedures for initiating work, payments, and closure of projects.

SFOR Engineer projects are generally funded by one of the following:

- NATO Infrastructure Committee (IC);
- NATO Military Budget Committee (MBC);
- National Funds;
- International Organizations;

SFOR Engineers are responsible for identifying Engineer requirements, priorities, scope of work and cost estimates for common funded projects and sub – projects within the SFOR AOR. This also includes deciding whether the work will be done by military engineers or contractors and who will manage the projects and sub – projects.

## MORE IMPORTANT PROJECTS

Project 52 — is the relocation and construction of facilities to house the Det Air, HQSFOR heliport and COMSFOR fleet at the Sarajevo Airport.

Project 54 — is the construction of an improved heliport for the COMSFOR Op Reserve at Eagle Base near Tuzla.

Task 485 — heliport recce at Eagle Base.

Task 508 — helipads construction at Eagle Base.

### REFERENCES

- [1] SFOR Engineering Projects SOP 7001 = Sarajevo Oct 2000.
- [2] CJ Engineers mission Brief = COL Dr. Padányi CHENG HQ SFOR Sarajevo 11/19/99.
- [3] General Framework Agreement for Peace in Bosnia and Herzegovina.





## CONTRIBUTIONS TO THE STUDY OF AN AXIAL COMPRESSOR STAGE BY THE MEANS OF THE GENERALIZED REACTION DEGREE CONCEPT

Keywords: generalized reaction degree, fluid flow into a stage, axial compressor, reaction force, reaction degree.

### BASIC THEORETICAL ASPECTS

For the case of a generalized nozzle, where simultaneously occur variations of mass and geometry, changes of the thermal and thermodynamical parameters, the thrust is given by the following equation:

$$T = \alpha \cdot \frac{\bar{M}^2 \cdot \bar{T}^*}{\bar{P}^*} + \beta \cdot \bar{P}^* \cdot \bar{S} + \gamma \bar{M} \cdot \sqrt{\bar{T}^*} - \delta \cdot \bar{S} + \varepsilon \quad (1)$$

where:

$$\alpha = C_1 \cdot \frac{\bar{R}}{\bar{a}} \cdot h_1 \cdot \sqrt{\bar{T}^*} \cdot q(\lambda_1) \cdot \dot{M}_1; \quad \beta = C_2 \cdot \bar{a} \cdot \bar{R} \cdot h_1 \cdot \sqrt{\bar{T}^*} \cdot \frac{1}{q(\lambda_1)} \cdot \dot{M}_1;$$

$$\gamma = C_3 \cdot \bar{R} \cdot h_1 \cdot \sqrt{\bar{T}^*} \cdot \dot{M}_1; \quad \delta = d = \frac{P_a}{P_1^*} \cdot \sqrt{\bar{T}^*} \cdot \frac{1}{q(\lambda_1)} \cdot \dot{M}_1;$$

$$\varepsilon = \delta - z(\lambda_1) \cdot h_1 \cdot \sqrt{\bar{T}^*} \cdot \dot{M}_1.$$

The reaction degree  $\rho_c$  of an axial compressor stage is defined as the parameter which appreciates the percentage from the effective work of the fluid static compression developed in the entire stage  $\Delta p_T$ , that is to be accomplished into the rotating blade rows  $\Delta p_R$ .

Considering a certain geometry of the fluid flow path inside the stage of an axial compressor, as it is shown in fig. 1, the reaction degree  $\rho_c$  could be expressed in different ways, according to the characteristics of the flow:

a) the case of the incompressible fluid flow

$$\rho_{c_c} = \frac{p_2 - p_1}{p_3 - p_2} = \frac{\Delta p_R}{\Delta p_T} \quad (2)$$

b) the case of the compressible fluid flow

$$\rho_{c_i} = \frac{i_2 - i_1}{i_3 - i_2} = \frac{\Delta i_R}{\Delta i_T} \quad (3)$$

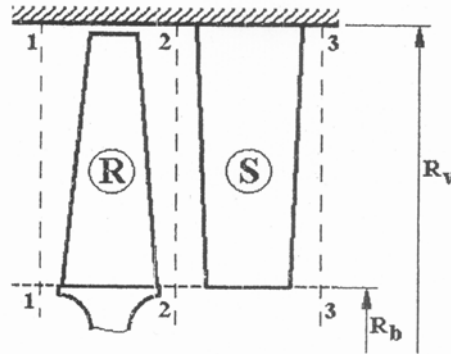

Fig. 1.

According to the principle of the thermodynamics, for the adiabatic evolutions, the variation of the enthalpy is:

$$\Delta i = \int \frac{dp}{\rho} \quad (4)$$

It comes up that the variation of the enthalpy  $\Delta i$  represents an image of the variation of the static pressure, i.e. of the fluid compression eventually; this is valid for either both the rotating part  $\Delta i_R$  and the entire stage  $\Delta i_T$ .

As it follows from (1), the pressure variation increases the fluid force which acts upon the row blades of the stage. This is the reason to define the parameter  $\rho_c$  as the reaction degree.

It is convenient to express the correlation of the reaction degree with the reaction forces developed by the blade row  $T_{R_R}$  and by the entire stage  $T_{R_T}$ . Under these circumstances, the reaction degree  $R_c$  should be redefined analytically in a more general way, such as

$$R_c = \frac{T_{R_R}}{T_{R_T}} \quad (5)$$

## THE THRUST OF THE AXIAL FLOW COMPRESSOR STAGE

Generally speaking, the axial flow compressor stage consists of a mobile row which is capable to transform part of the mechanical work in energy by air breaking in blade to blade chanel and a fixed row in wich continues air compression. We will treat one at a time the thrust in both of these rows and finally we will establish the thrust of the whole stage. Now, we consider the equation of the thrust in an absolute reference system:

$$T = M_2 V_2 \cos \alpha_2' - M_1 V_1 \cos \alpha_1' - p_1 S_1 \cos \varphi_1 + p_2 S_2 \cos \varphi_2 + p_H (S_1 \cos \varphi_1 - S_2 \cos \varphi_2) \quad (6)$$

### The thrust developed by the stator

In fig. 2 it is represented a cylindrical section in a fixed compressor row.

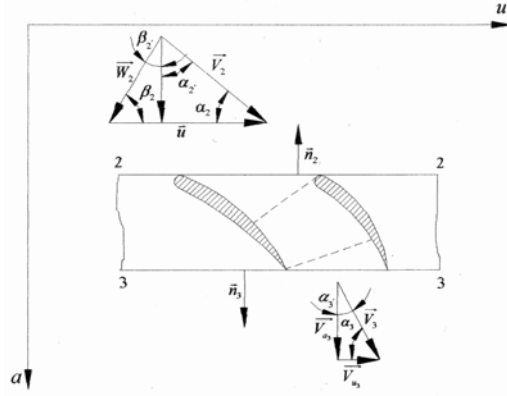

Using (6), it results the relation for the trust of the stator:

$$T_s = M_3 V_3 \cos \alpha_3' - M_2 V_2 \cos \alpha_2' - p_2 S_2 \cos \varphi_2 + p_3 S_3 \cos \varphi_3 + p_H (S_2 \cos \varphi_2 - S_3 \cos \varphi_3) \quad (7)$$

where the reaction  $T_{SR}$  and pressure  $T_{SP}$  components are:

$$T_{SR} = M_3 V_3 \cos \alpha_3' - M_2 V_2 \cos \alpha_2' \quad (8)$$

and

$$T_{SP} = p_3 S_3 \cos \varphi_3 - p_2 S_2 \cos \varphi_2 + p_H (S_2 \cos \varphi_2 - S_3 \cos \varphi_3)$$

or

$$T_{SP} = S_3(p_3 - p_H) \cos \varphi_3 - S_2(p_2 - p_H) \cos \varphi_2 \quad (9)$$

In fig.2 the deviations angles of  $n_2$  and  $n_3$  referred to axial  $r-a$  plane are nuls:

$$\varphi_2 = \varphi_3 = 0$$

The thrust components of the stator are:

$$T_{SR} = M_3 V_3 \cos \alpha'_3 - M_2 V_2 \cos \alpha'_2$$

and

$$T_{SP} = S_3(p_3 - p_H) - S_2(p_2 - p_H) \quad (10)$$

We mention that in the stator there is no fluid mass apport and for the mass flow in the fundamental sections it is valable the relation:

$$M_2 = M_3 = M \quad (11)$$

The expressions of the two components of the thrust (reaction and pressure) are:

$$T_{SR} = M(V_3 \cos \alpha'_3 - V_2 \cos \alpha'_2) \quad (12)$$

$$T_{SP} = S_3 p_3 - S_2 p_2 - p_H (S_2 - S_3) \quad (13)$$

If the axial component of the absolute speed is an invariant ( $V_{a1} = V_{a2} = V_{a3} = V_a$ ) then:

$$V_1 \cos \alpha'_1 = V_2 \cos \alpha'_2 = V_3 \cos \alpha'_3 \quad (14)$$

and the reaction component of the thrust of the stator is  $T_{SR} = 0$ .

In this case, the force applied on the stator is:

$$T_S = T_{SP} = S_3(p_3 - p_H) - S_2(p_2 - p_H) \quad (15)$$

## 2.2 The thrust developed by the rotor

The geometry of the mobile row is presented in fig.3.

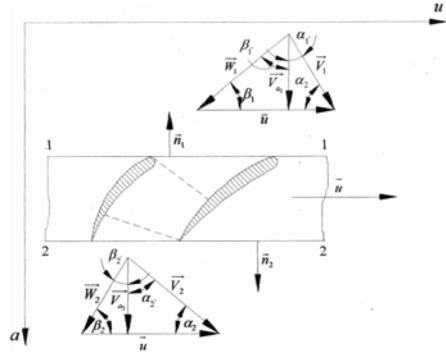

Using (6) applied in a mobile reference system:

$$T_R = M_2 W_2 \cos \beta_2' - M_1 W_1 \cos \beta_1' - p_1 S_1 \cos \varphi_1 + p_2 S_2 \cos \varphi_2 + p_H (S_1 \cos \varphi_1 - S_2 \cos \varphi_2) \quad (16)$$

It could be also use the assumption  $\varphi_1 = \varphi_2 = 0$  and in this case, the expression of the thrust of the rotor is:

$$T_R = M_2 W_2 \cos \beta_2' - M_1 W_1 \cos \beta_1' - S_1 (p_1 - p_H) + S_2 (p_2 - p_H) \quad (17)$$

The expressions of the two components  $T_{RR}$  (the reaction component) and  $T_{RP}$  (the pressure component) are:

$$T_{RR} = M_2 W_2 \cos \beta_2' - M_1 W_1 \cos \beta_1' \quad (18)$$

$$T_{RP} = S_2 (p_2 - p_H) - S_1 (p_1 - p_H) \quad (19)$$

If there is no fluid mass apport, we have:

$$M_1 = M_2 = M \quad (20)$$

and the reaction component could be write as:

$$T_{RR} = M (W_2 \cos \beta_2' - W_1 \cos \beta_1') \quad (21)$$

If the axial component of the absolute speed is an invariant then:

$$W_1 \cos \beta_1' = W_2 \cos \beta_2' = V_a = ct. \quad (22)$$

and  $T_R = 0$

Then, the thrust developed by the rotor is the result of the thrust obtained by air compression in blade to blade channels:

$$T_R = T_{RP} = S_2(p_2 - p_H) - S_1(p_1 - p_H) \quad (23)$$

## THE GENERALISED REACTION DEGREE

The reaction degree is, by definition, given as a solution of (3) in which, the reaction component is given by (21) and the reaction component of the stage thrust is given by:

$$T_{RT} = T_{RR} + T_{SR} \quad (24)$$

where  $T_{SR}$  is given by (12).

## CONCLUSIONS

The generalised degree of reaction  $R$  being a function of the ratio  $l^*c/i^*$  depends mainly on the magnitude of the mechanical work on the compression  $l^*c$  and the value of the pressure ratio  $\pi_c^*$ , respectively and it is influenced by the ambient and flight conditions (in terms of pressure, temperature and flight speed) by the means of the total enthalpy,  $l_i^*$ .

It follows up that a more general way to optimise the flow into an axial stage of a compressor is to take into consideration the relation between the mechanical work on compression and the generalised degree of reaction.

## REFERENCES

- [1] VIRGIL Stanciu, Bazele proiectării compresoarelor axiale subsonice, lit. IPB, 1990.
- [2] VIRGIL Stanciu, Motoare aeroreactoare, Îndrumar de anteproiectare, lit. IPB, 1992.
- [3] VIRGIL Stanciu, Calculul și optimizarea performanțelor sistemelor de propulsie, lit. IPB, 1992.
- [4] VIRGIL Stanciu, Sisteme moderne de creștere a tracțiunii și economicității motoarelor aeroreact. Lit. IPB, 1993.
- [5] V. Pimsner, Mașini cu palete, procese și caracteristici, Ed. Tehnică, București, 1998.
- [6] V. Pimsner, Motoare aeroreactoare, Ed. Didactică și Pedagogică, București, 1983.
- [7] V. Pimsner, C. Berbente, VIRGIL Stanciu, Procese în mașini cu palete, Aplicații și probleme, Ed. Tehnică, București 1985.

## AUTOMATIC LANDING SYSTEM FOR UAV

### INTRODUCTION

The Unmanned Aerial Vehicle (UAV) system is designed for the real time safe and low cost TV or IR aerial reconnaissance, monitoring of contaminated and inaccessible areas, artillery fire monitoring, radio reconnaissance and jamming, border patrol, search and rescue (SAR) assistance, or it can be used as an aerial target.

UAV control is either semi- or fully automatic. The flight plan can be preprogrammed before take-off or during flight.

Navigation is via GPS and there is real-time data-link between the UAV and its Ground Control Station (GCS), allowing the ground crew to monitor real-time on-board optoelectronic sensors and the airplane position (displayed on a digital map). The main flight data are displayed on displays at GCS:

$V_{gl}$  — gliding velocity (usually:  $V_{gl} = 1.3 * V_p$ );

$V_p$  — atalling speed (= 100km/h);

$\vartheta_{gl}$  — grade of the UAV on the glide;

$V_y$  — vertical speed;

$V_{yd} = -0.5 \div -0.6 \text{ ms}^{-1}$  is acceptable vertical speed at the touch point, ie.

$V_{yd} \cong 0.8-0.9 * V_{gl}$ ,

For our purposes is best suitable the exponential trajectory of landing. The shape of exponential trajectory see Figure 1.

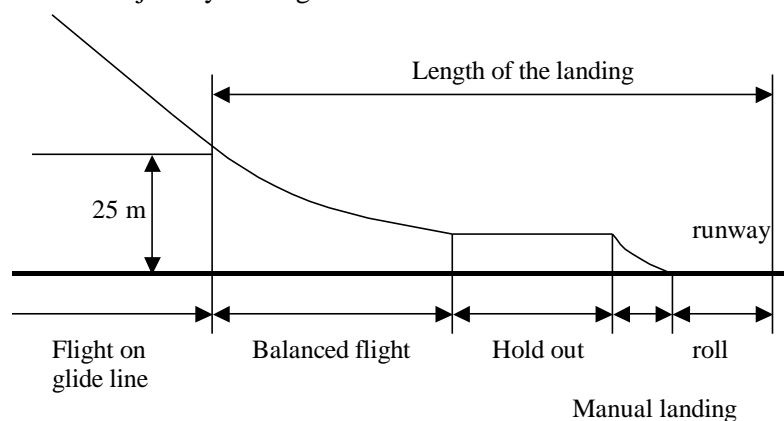

Fig. 1. Stages of the landing the UAV



## STAGES OF THE LANDING

The UAV is approaches to the runway at the altitude  $H$  of the speed  $V$ . At the given distance from runway starts the UAV gliding, it is caused manually or automatically, the trajectory slope  $\vartheta_{gl}$  at this moment is  $2.5^\circ-3^\circ$ . To reduce the vertical speed  $V_y$  during the flight on glide line, it is necessary to minimize the grade. This stage of crossing from flight on glide line to the parallel flight with runway is called balanced flight. During the manual flight the plane is lead to the trajectory parallel to runway, this stage is called hold on, on this stage, the plane flights at the altitude  $H= 0.5-1m$  above the ground and gradually losing its speed. At the end of hold on stage is velocity approaching the landing speed. To hold on the lift the pilot is increasing the angle of attack during this stage  $\alpha$ . Concerning all possible balanced trajectories we will take into account only exponential trajectory, which were accepted for landing of civil aircrafts. We obtain this trajectory assuming, that in every point the vertical speed  $V_y$  of the UAV will be proportional to the actual altitude  $H$ , i.e.:

$$-H'(t) = cH(t), \quad (1)$$

where:

$c$  — is a proportional figure;

$H(t)$  — altitude;

$H'(t)$  — vertical speed.

Denote  $T=1/c$  exponential figure, then we can transform the equation (1), using Laplace transform to the form (zero initial conditions):

$$(Ts+1) H(s) = 0 \quad (2)$$

Solving this differential equation (resp. its picture) with initial altitude condition  $H_0$  (25m), we obtain the function of the altitude during the flight.

$$H(t) = H_0 e^{-t/T} \quad (3)$$

Where:

$H_0$  — is initial altitude;

$T$  — is exponential figure.

With respect to effective landing, the hold on stage isn't used during the automatic landing. Then the balanced flight is finished by touching the runway.

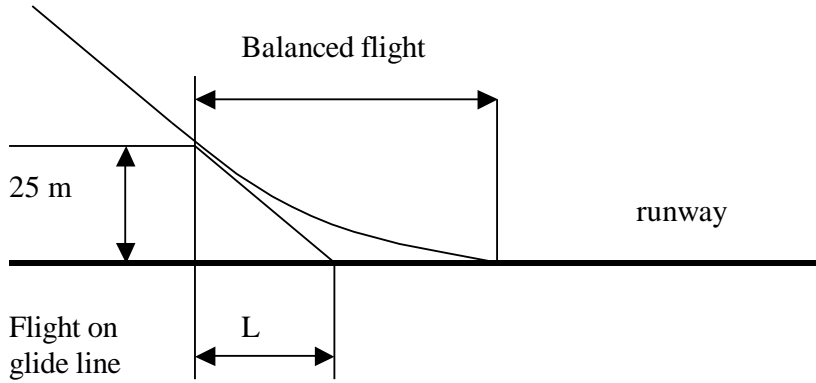

Fig. 2. Stages of the landing the UAV, no stage hold on

Let us consider that during the stage of balanced flight the velocity changes little, for that we will assume the velocity steady and equal to  $V_{avg}$  (average speed =  $(V_{gl} - V_{land})/2$ ). In that case the equation of trajectory has the form::

$$H(l) = H_0 e^{-l/L} \quad (4)$$

Where:

$l = Vt$  — Distance from the beginig of balanced flight stage;

$L = VT$  — Exponential figure of balanced flight.

To accomplish crossing from balanced flight to hold on stage it is necessary that glide line is equal to the hold on exponential at the beginig of flight on glide line. That is true when this condition is also true:

$$L = H_0 / \vartheta_{gl} (=H_0 / \text{tg}(\vartheta_{gl})) \quad (5)$$

or

$$T = H_0 / V\vartheta_{gl} \quad (6)$$

During the flight of the UAV on the exponetial trajectory according the equitation (1), the Uav is aproaching the runway. Theoretically it will never touch the ground. Distance  $l$  from the beginig of balanced flight stage to the point of altitude  $H(l)$  is given by:

$$l = L \ln (H_0 / H(l))$$

Due, the altitude  $H(l)$  is null at the end of landing, we obtain  $l = \infty$ , distance of balanced flight is infinite. It should be shorten, we let the UAV to has some

vertical speed at the moment of touching the ground  $V_{y\text{touch}}$  ( $H'_{y\text{touch}}$ ). In coincidence with the equation (2) has the UAV such a vertical speed at the altitude:

$$H = T H'_{y\text{touch}} \quad (7)$$

Proto, aby letoun měl při dosednutí vertikální rychlost  $H'_{y\text{touch}}$  je nutné aby asymptota k exponenciální přistávací traektorii byla pod povrchem VPD ve vzdálenosti  $H_{as}$  dané závislostí (7). Při  $T = 2-5\text{s}$  a  $H'_{\text{dosednutí}} = 0.3 - 0.6 \text{ ms}^{-1}$  asymptota exponenciály musí být pod povrchem VPD  $H_{as} = 0.6 - 3\text{m}$ .

## FUZZY DATA BASE

For the automatic landing task we divided input space  $\Delta V_y = (V_{yp} - V_y)$  to the five fuzzy sets:

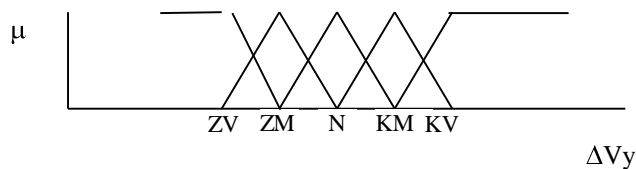

Fig. 3. Division of Input space of landing autopilot

Output space  $\delta v$  we divided by the same way:

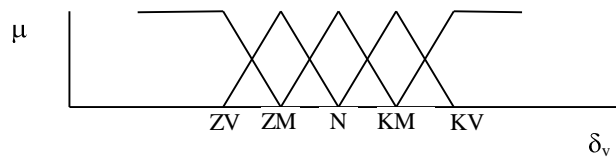

Fig. 4. Division of Output space of landing autopilot

As fuzzy membership function we used the L and  $\Lambda$  functions. Choice of input and output intervals of fuzzy sets.

All intervals were set by evaluation of real flight data recorded during the flight of UAV Sojka III TV/TVM, which was developed in the Air Research Institute Prague.

$$\begin{aligned} \Delta V_y &= -9 \div 9, \\ \omega z &= -0.6 \div 0.6, \\ \delta v &= -0.05 \div 0.05, \end{aligned}$$

## FUZZY RULE BASE

On the base of theoretical analysis will be automatic landing process controlled by fuzzy autopilot as follows:

- Ap to altitude 25m will UAV steadily descent — ie. control of altitude and pitch.
- At the altitude 25m the fuzzy landing controler will be switched on. Vertical speed  $V_{yp}$  is proportional to the actual altitude H.
- At every point there will be dispropotion between actual and required vertical speed. This dispropotion will be input parameter to the fuzzy autopilot.
- Output parameter of the fuzzy autopolit will be movement of elevator so that the dispropotion is minimized.

When  $V_{yp} = V_y$  the UAV is in the state 1  $\Delta V_y = N$ . UAV is in steady parallel flight. Let us assume the positive change of required vertical velocity  $V_{yp}$ , ie.  $(V_{yp} - V_y) > 0$ . UAV state is changed to the state 2 :  $\Delta V_y = KV$ ,  $1 \rightarrow 2$ . In this case it is necessary to move the elevator to negative deviation. The torque, caused by move of elevator will cause change of pitch ie.  $\theta' > 0$ , and this will lead to change of vertical speed. When the vertical speed increases to the required value  $V_y \rightarrow V_{yp}$  we get to the state 3.

By the same way we can derive the rules for  $(V_{yp} - V_y) < 0$ .

Fuzzy Rules Table for vertical speed control

Table 1.

$\Delta V_y$	ZV	ZS	ZM	N	KM	KS	KV
	KV	KS	KM	N	ZM	ZS	ZV

The diagram shows three boxes labeled 2, 3, and 1. An arrow points from box 2 to box 3. Another arrow points from box 3 to box 1. A third arrow points from box 1 back to box 2, forming a cycle.

Table 1 can be displayed in the form if-then rules.

If-then rules of landing autopilot Table 2.

1. If ( $\Delta V_y$  is ZV) then (dv is KV) (1)
2. If ( $\Delta V_y$  is ZS) then (dv is KS) (1)
3. If ( $\Delta V_y$  is ZM) then (dv is KM) (1)
4. If ( $\Delta V_y$  is N) then (dv is N) (1)
5. If ( $\Delta V_y$  is KM) then (dv is ZM) (1)
6. If ( $\Delta V_y$  is KS) then (dv is ZS) (1)
7. If ( $\Delta V_y$  is KV) then (dv is ZV) (1)

## CONCLUSION

Figures 5,6,7 shows the output – vertical speed, altitude, pitch and elevatr during simulation of the landing process. From the figures, we can see that the proces is steady and non flitting.

Concerning the complexity of the automatic landing process we can state that designet fuzzy autopilot is effective. Taking int account, that there is no automatic systém for landing of the UAV Sojka, it is also appreciable, that this landing systém can be used in real UAV.

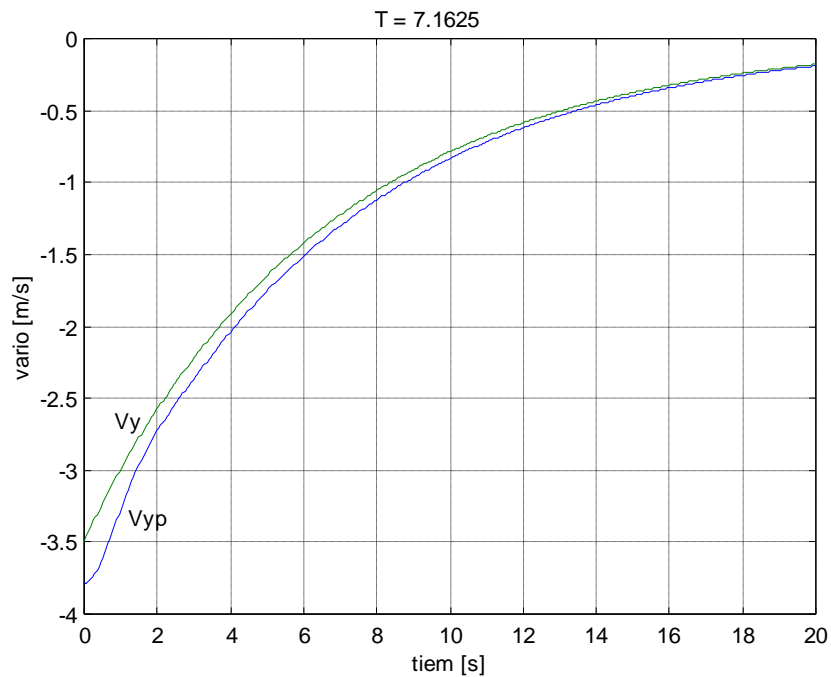

Fig. 5. Vertical speed – actual and required

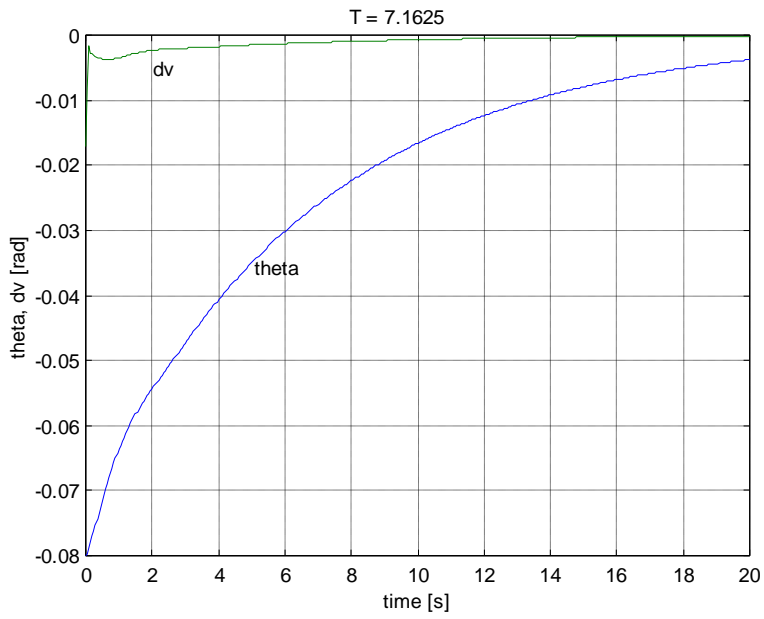

Fig. 6. Elevator and Pitch

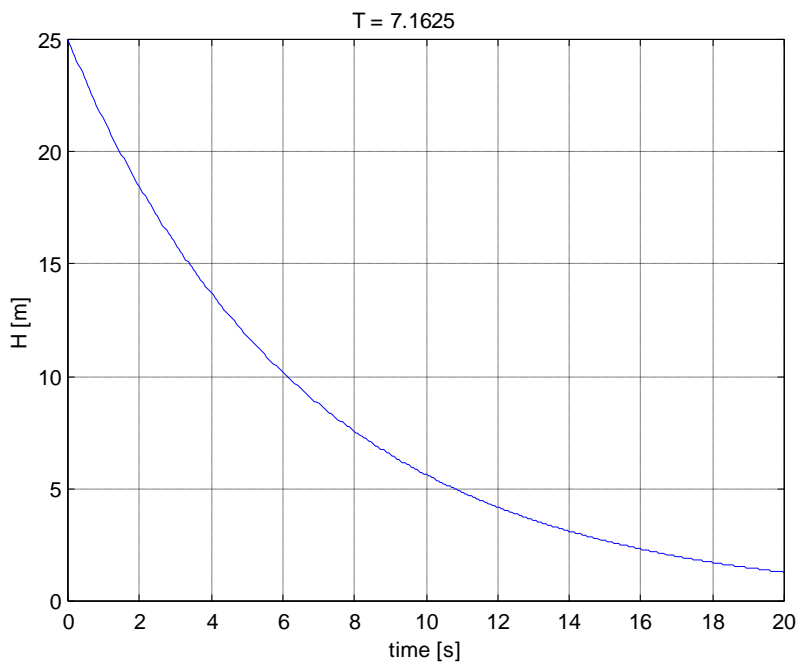

Fig. 7. Altitude



## **DISTORTION SOLUTION OF THE ILS LOCALIZER COURSE LINE BY PC SUPPORT**

### **INTRODUCTION**

On a normal flight, an aircraft flies at cruising altitude to its destination, where it begins its descent and intercepts the projected runway centreline, then makes a final approach with an accuracy of a few feet in each axis at touchdown. Land-based military and civil aircraft rely on the instrument-landing system (ILS), a low-altitude approach system that does not provide guidance signals all the way to touchdown. The ILS consists of a glide-path (GP) beam and localizer (LLZ) beam installed on the runway (RWY) area.

The GP provides vertical steering signals for landings in front course on the RWY. The localizer provides lateral steering signals approaches on the RWY. Two 75 MHz marker beacons provide spot checks of positioning at  $1,05 \pm 0,15$  kilometres range and 7,2 kilometres along the front course. The marker beacons unable to determine of the aircraft altitude by means of the airborne radio altimeter. In the special case the ILS can be extended by Distance Measuring Equipment (DME) for continues measuring of the aircraft range to the touchdown point.

The glide-path antenna establishes a radiation pattern in space from which a signal is derived proportional to the vertical displacement from the glide path. The glide-path angle is usually  $2,5^\circ$  to  $3,0^\circ$ . This signal drives the up-down cross-pointer needle or flight direction.

The localizer establishes a pattern in space whose signal is proportional to lateral displacement from the vertical plane through the runway centreline. This signal drives the left-right cross-pointer needle or flight direction.

Because the localizer and glide path transmissions of the continuous-wave type, reflections to the aircraft from surface irregularities, hills, vegetation, bushes, snow cover and other aircraft will cause bends in the course and path line. Consequently that received signal is the vector sum of all energy arriving at the aircraft's antenna, including both from direct and reflected. At sites that do not have flat land in front of the runway, the reflected signals from the surface irregularities cause the course and glide line distortion.

In the case of the GP system the glide line distortion can be suppressed by means of the special antenna system. But in the case of the localizer antenna system it is impossible. For suppressing the course line distortion, we have two possibilities:



- *Firstly*: to smooth the terrain before the localizer antenna;
- *Secondly*: to calculate the course line distortion, alternatively how the distortion is also called - waviness of the course line, by PC support. In this way to determine the course line distortion.

This work is oriented at the ILS/Localizer course line distortion calculation by means of PC support.

## DESCRIPTION OF THE ILS LOCALIZER

The localizer is the lateral guidance portion of the instrument landing system. The course line is aligned with the projected runway centreline.

The radiation from the antenna system produces a complete pattern that is amplitude modulated by 90 and 150 Hz navigation tones with 20% depth of modulation for both tones. The difference in depth of modulation (DDM) of 90 and 150 Hz in the localizer coverage area changes in accordance with the azimuth angle. On the left-hand side of the runway, looking from the antenna down the length of the runway, the depth of modulation of the 150 Hz navigation tone is higher than the 90 Hz navigation tone. On the right-hand side of the runway, the 150 Hz navigation tone predominates. On course line both navigation tones have the same depth of modulation, resulting in a DDM equal to zero. Hence, the DDM gives information of the correct course line and on which side of the course line the aircraft is positioned.

The aircraft localizer receiver measures the DDM. The left-right cross-pointer indicator shows the aircraft position in the localizer covering area.

The localizer antenna is located within 300 and 500 meters beyond the stop end of the runway, centred on the runway centreline (Fig. 1. The localizer antenna).



Fig. 1. The localizer antenna

The localizer horizontal antenna patterns enable to evaluate the aircraft position in the approach area.

Because the radiations are of continuous-wave type, reflections from terrain, buildings, aircraft (taxiing), and ground vehicles will reflect spurious energy to the approaching aircraft to the landing, resulting in a bend, distortion and waviness, in the course line.

## MATHEMATICAL ANALYSES OF THE ANTENNA PATTERN SOLUTION BY PC SUPPORT

Firstly the horizontal antenna pattern values and characteristics are calculated. The calculation can be realized both to measure that in the real conditions on the airfield and to calculate them from the function of the antenna radiation. Because, there have not been any antenna pattern measured values available, the PC calculation is used from the real part of the antenna radiation function. The antenna radiation function is given by [1, 2]:

$$F_{(\vartheta)_{L_1, L_2, R_1, R_2}} = \frac{\pi^2 \cos\left[\frac{kl_1}{2} \sin(\vartheta \pm \Theta)\right]}{\pi^2 + \sin\left(\frac{kl_1}{2} \vartheta \pm \Theta\right)^2} \quad (1)$$

Where:

$k = 2\pi/\lambda$ ;

$l_1$  – is the antenna size;

$\Theta$  – is the misalignment of the antenna axis;

$\vartheta$  – is the independent variable angle.

The left and the right antenna patterns of the localizer is given by the following equation

$$F_{(\vartheta)_{LocalizerLeft}} = F_{(\vartheta)_{L_1}} + F_{(\vartheta)_{L_2}} \quad (2)$$

$$F_{(\vartheta)_{LocalizerRight}} = F_{(\vartheta)_{R_1}} + F_{(\vartheta)_{R_2}} \quad (3)$$

For calculation of the localizer coverage a standardized antenna pattern is needed. It means, the maximum value of the left and right antenna patterns  $F_{(\vartheta)_{Left-max}}$  and  $F_{(\vartheta)_{Right-max}}$  are calculated, and then the standardized antenna pattern will be calculated as follows:

$$F_{(\vartheta)standard} = \frac{F_{(\vartheta)}}{F_{(\vartheta)max}} \quad (4)$$

The difference in depth of the modulation is given by the following equation

$$DDM = \frac{m.(F_{(\vartheta)_L} - F_{(\vartheta)_p})}{F_{(\vartheta)_R} + F_{(\vartheta)_L}} \quad (5)$$

Where m is the amplitude modulated signal depth and m = 0,2 or 20%. Displacement sensitivity of the localizer is expressed

$$S_{localize} = \frac{\Delta DDM}{\Delta \vartheta} \quad [ \% / ^\circ ] \quad (6)$$

The antenna radiation function values and the graphic presentation have been calculated particularly in the EXCEL-97 and MATLAB version 5.1.3. The statically computed mode has been selected.

## MATHEMATICAL ANALYSES OF THE COURSE LINE WAVINESS SOLUTION BY PC SUPPORT

As already mentioned, the radiations are of continuous-wave type, reflections from terrain, buildings, aircraft (taxiing), and ground vehicles will reflect spurious energy to the approaching aircraft to the landing, resulting in a bend, distortion, waviness, in the course line. The reflexion characteristics of the terrain object are diffusion in the localizer covering area. The direct signals with the reflected signal add on the airborne receiver antenna, which results in waviness of the course line (Fig. 2. Composing of the direct and reflected wave).

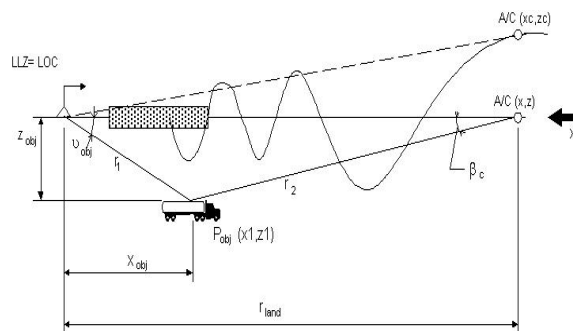

Fig. 2. Composing of the direct and reflected wave

Difference trajectory propagation of the reflected and direct electromagnetic wave results in phase changes  $\Delta\varphi$  of the received signal [1, 2]. The  $\Delta\varphi$  depends on the

$$\Delta R = R_{\text{reflected signal}} - R_{\text{direct signal}} = (r_1 + r_2) - r_{\text{lend}} = (r_1 + r_2) - x \quad (7)$$

$$\Delta\varphi = k \cdot x \cdot \cos(1 - \cos \beta_c) \quad (8)$$

The resulting difference in depth of modulation is

$$DDM_{\text{result}} = DDM_{\text{direct wave}} + DDM_{\text{caused by reflection}} \quad (9)$$

The  $DDM_{\text{direct wave}} = 0$  at the course line. The result  $DDM_{\text{result}} = DDM_{\text{caused by reflection}}$  then

$$DDM_{\text{result}} = \eta \left[ \frac{F_R(\vartheta_{\text{object}}) - F_L(\vartheta_{\text{object}})}{2 \cdot F(\vartheta=0)} \right] \cdot \sin \left\{ kx \left[ 1 - \cos \left( \text{atg} \frac{z_{\text{obj}}}{x - x_{\text{obj}}} \right) \right] \right\} \quad (10)$$

The object coordinates can be changed according to true conditions.

Angular deviation of the course line from the RWY axis (correct course line) is the result of the reflected transmitted signals from the terrain surface is given by

$$\Delta\beta = \frac{\eta}{S_{\text{localizer}}} \left[ \frac{F_R(\vartheta_{\text{object}}) - F_L(\vartheta_{\text{object}})}{2 \cdot F(\vartheta=0)} \right] \cdot \sin \left\{ kx \left[ 1 - \cos \left( \text{atg} \frac{z_{\text{obj}}}{x - x_{\text{obj}}} \right) \right] \right\} \quad (11)$$

Lateral deviation of the aircraft from extension lengthwise axes RWY is the result of the reflected transmitted signals from the terrain surface is given by

$$\Delta Z_{\text{aircraft}} = x \cdot \text{tg} \frac{\eta}{S_{\text{localizer}}} \left[ \frac{F_R(\vartheta_{\text{object}}) - F_L(\vartheta_{\text{object}})}{2 \cdot F(\vartheta=0)} \right] \cdot \sin \left\{ kx \left[ 1 - \cos \left( \text{atg} \frac{z_{\text{obj}}}{x - x_{\text{obj}}} \right) \right] \right\} \quad (12)$$

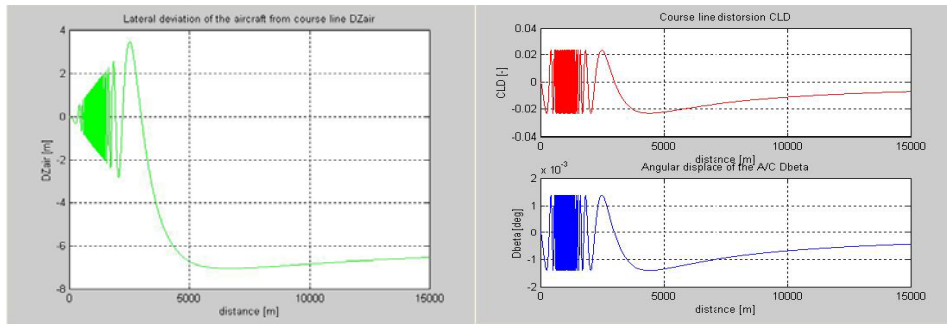

Fig. 3. Left: Lateral deviation of the A/C from the course line; Right: Course line distortion and angular displacement of the A/C

Elongation of the cross indicator pointer depends on the supply current  $\Delta I_{CPI}$  value coming from the airborne localizer evaluation equipment. This current value is given by the following equation (Fig. 4. Cross point indicator current).

$$\Delta I_{CPI} = S_{A/C \text{ receiver}} \cdot \Delta \beta \quad (13)$$

$$\Delta I_{CPI} = \eta \frac{S_{A/C \text{ receiver}}}{S_{localizer}} \left[ \frac{F_R(\vartheta_{object}) - F_L(\vartheta_{object})}{2 \cdot F(\vartheta=0)} \right] \cdot \sin \left\{ kx \left[ 1 - \cos \left( \text{atg} \frac{z_{obj}}{x - x_{obj}} \right) \right] \right\} \quad (14)$$

The calculated values show the frequency of the  $\Delta I_{CPI}$  increasing in dependencies on the decreasing distance of the approaching aircraft from RWY threshold. The frequency of the oscillations determines the following equation

$$f_{Waviness} = \frac{V_{A/C}}{\lambda} \left( 1 - \cos \left[ \text{atg} \frac{z_{obj}}{x - x_{obj}} \right] \right) \quad (15)$$

Where  $V_{A/C}$  is the speed of the approaching aircraft. When the  $f_{waviness} > 3 \text{ Hz}$  is suppressed by the board evaluation system.

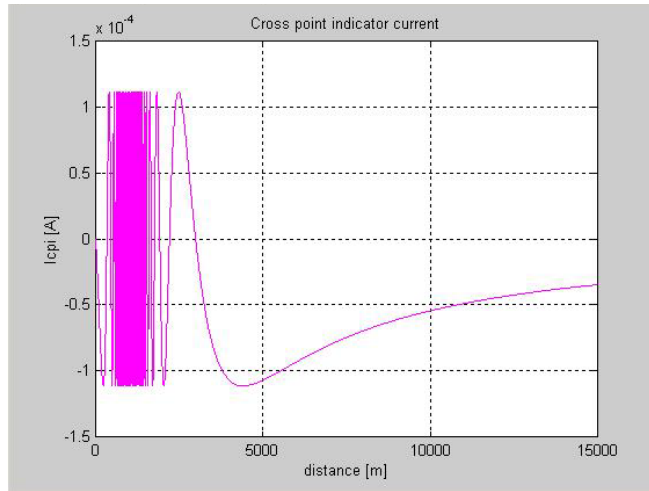

Fig. 7. Cross point indicator current

## CONCLUSION

The presented work is oriented at the determination of the Localizer course line in the real airport environment. Programming solution results consist in the detection of the terrain surface to the ILS activity. Program on the basis of the object coordinate solves analytically and graphically the aircraft deviation both from the course line and the cross pointer indicator current depending on distance of the aircraft from the runway thresholds. The results of this work are applicable both in the teaching process, and practically in true condition of the airfield.

### REFERENCES

- [1] KAYTON M.: Avionics navigation systems. John Wiley & Sons. New York. 1969.
- [2] LUŽICA Š.: Letecké elektronické systémy. Část II. Letecké přistávací systémy. Vojenská akademie. Brno. 1992.
- [3] MATLAB: Reference handbook.
- [4] TECHNICAL HANDBOOK: ILS system, type Normarc 7000.



## **THE NATO STANDARD SAFETY INVESTIGATION PROCEDURES WHICH SHOULD BE INTEGRATED INTO HOME REGULATIONS**

The Hungarian safety investigation concept differs in many ways from the NATO standards. First of all the home regulations don't make difference between safety and departmental investigations. This is the reason why they don't so effective.

Usually the accidents are caused by adverse interactions of man, machine and environment. Investigations and assessment of these elements should reveal human, material and/or environmental factor that caused or contributed to one or more system inadequacy (deviations). These deficiencies are usually attributable to leader, standards, training, individual, or support failure. Although an accident occurs "after the fact" its primary focus must be an identifying what happened and why it happened.<sup>1</sup>

After the identifying system inadequacy the appropriate activity(s) responsible for correcting them should be notified. This is the "3W" approach to information collection, analysis and remedial measures.

The procedures are designated to assist us find answers the following basic questions:

- When did the system inadequacies (error, failure, environmental factor injury) occur?
- What happened? (human, material, environmental factor injury)
- Why did it happen? (system inadequacies, root cause(s))
- What should be done about it? (remedies for system inadequacies root cause(s))<sup>2</sup>

Highlight the significant elements of the safety investigation from different point of view; this is the goal of my short presentation.

---

<sup>1</sup> Army Accident Investigation and Reporting, Headquarters Department of the Army, Washington, DC, 1 November 1994, (Chapter 1, 1-5. Concept).

<sup>2</sup> Army Accident Investigation and Reporting, Headquarters Department of the Army, Washington, DC, 1 November 1994, (Chapter 3, Sequence of Events).



# ACCIDENT CAUSATION

## What causes accidents?

For successfully managed and effective accident prevention program we should understand what causes accidents.

Early man attributed hurtful happenings or accidents to the spirits. Later a more sophisticated view was accepted. The injured person was at fault because he should be “Punished”, he was “careless” or simple “stupid”<sup>3</sup>.

In the time of early industrial revolution workers who were injured, were hurt because they weren’t “careful”. Accidents were considered a natural side effect of production. At that time factory managers and workers considered accidents are cost of doing business, and people always had been and always would be careless (Figure 1).<sup>4</sup>

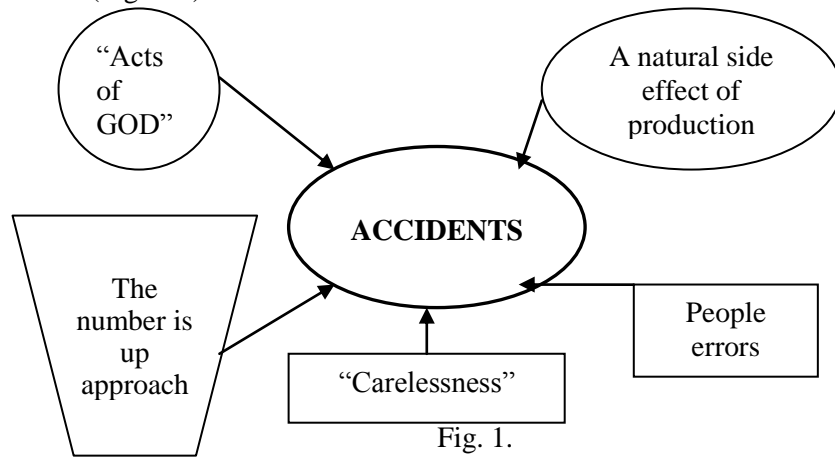

Fig. 1.

The court system upheld the view of individual responsibility for safety. Employers become to see the financially would be more effective to prevent accidents. They started to work out safety programs.

The modern causation model opens many effective countermeasures. The U.S. Army System model is simply a group of interrelated parts which, when working together as they were designed to do, accomplish a goal.<sup>5</sup>

The elements of the system are:

<sup>3</sup> Aviation Accident Investigation, Student Handout, US Army Safety Center, Fort Rucker, Alabama, May 1996. Page 2.

<sup>4</sup> Aviation Accident Investigation, Student Handout, US Army Safety Center, Fort Rucker, Alabama, May 1996. Page 3.

<sup>5</sup> Aviation Accident Investigation, Student Handout, US Army Safety Center, Fort Rucker, Alabama, May 1996. Page 10.

- Task- communication, controls, arrangements, demands on men, and time aspects;
- Person:
  - Selection mentally, emotionally, physically, and qualified;
  - Motivation positive, negative, and retention.
- Training:
  - Types;
  - Targets;
  - Considerations.
- Environment;
- Material.

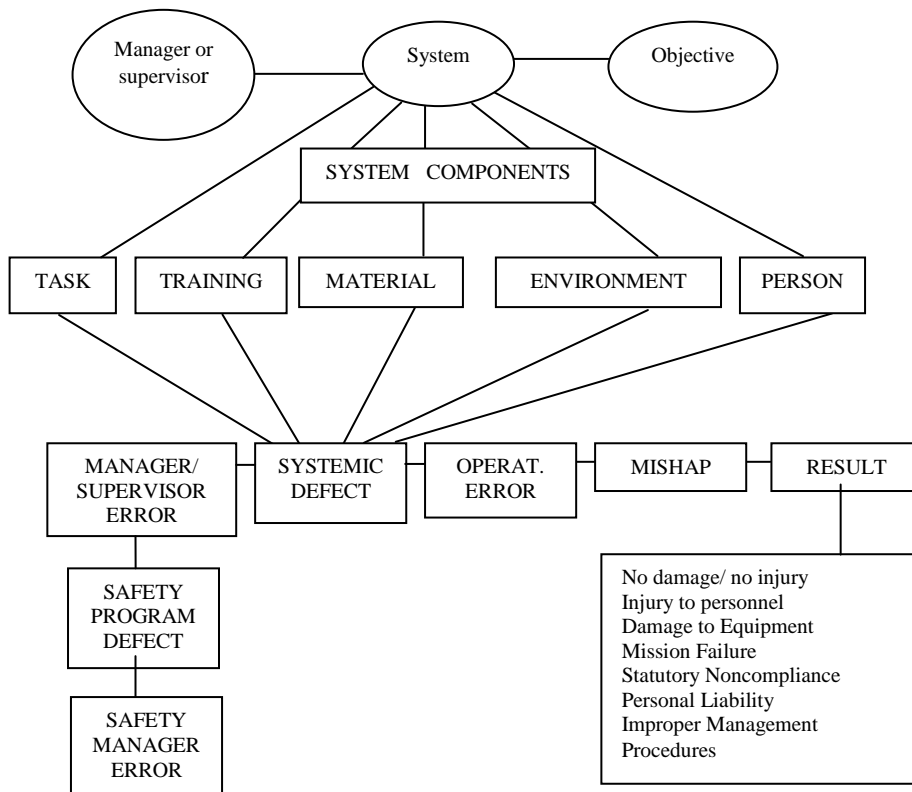

Fig. 2.<sup>6</sup>

<sup>6</sup> Aviation Accident Investigation, Student Handout, US Army Safety Center, Fort Rucker, Alabama, May 1996. Page 11.

# ACCIDENT INVESTIGATION

## “3W” Approach to Information Collection, Analysis and Recommendations<sup>7</sup>

Why we should investigate accidents?

First of all, if we do not report the accidents we can not investigate it. If we can not investigate accidents the problem will go undetected and people will continue to be injured and equipment damaged. We should investigate accidents to protect personnel and equipment by identifying problems as early as we can and countermeasures can be developed. Investigating provides commanders with about the unit readiness and health hazards.

The successful accomplishment of an accident investigation will depend upon how it is planned, organized, and conducted. The investigation plan is a systematic procedure that will ensure continuity of efforts from the examination of the crash site to the submission of the final report.

The plane is divided four different phases:

1. Organization and preliminary examination (accident side).
2. Data collection (Human, Material, Environmental factors).
3. Analysis of data (findings and recommendations).
4. Completing the technical report.<sup>8</sup>

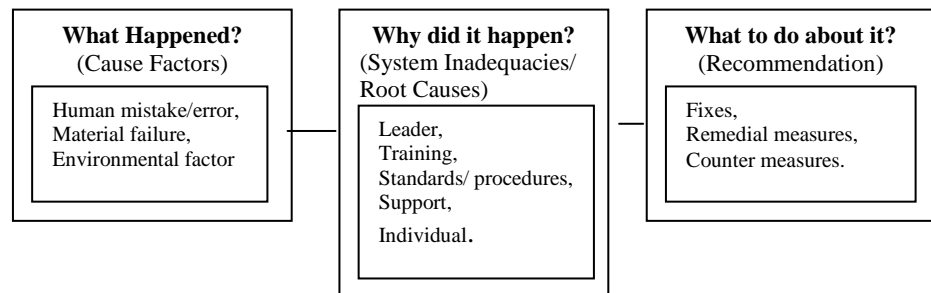

Fig. 3.

The definition of an accident is: an unplanned event or chain of events that results the flight can not be finished via pre-planned way, the aircraft is

<sup>7</sup> Aviation Accident Investigation, Student Handout, US Army Safety Center, Fort Rucker, Alabama, May 1996. Page 9-11.

<sup>8</sup> Army Accident Investigation and Reporting, Headquarters Department of the Army, Washington, DC, 1 November 1994, (Chapter 2, 2-1 Organization and planning)

destroyed, missing, or abandoned. The injury or occupational illness results in a fatality or permanent total disability.<sup>9</sup> (See the Flight Event Diagram below, Figure 4.)

### Flight event diagram

Produced by: Lt. Col. Zoltán Siklósi

When did error/failure/environmental factor/injury occur?

What happened? (Cause Factors: Human mistake/error; material failure; environmental factor)

Why did it happen? (System inadequacies/Root causes: leader; training; standards/procedures; support; individual.)

What to do about it?(Recommendations: fixes; remedial measures; countermeasures)

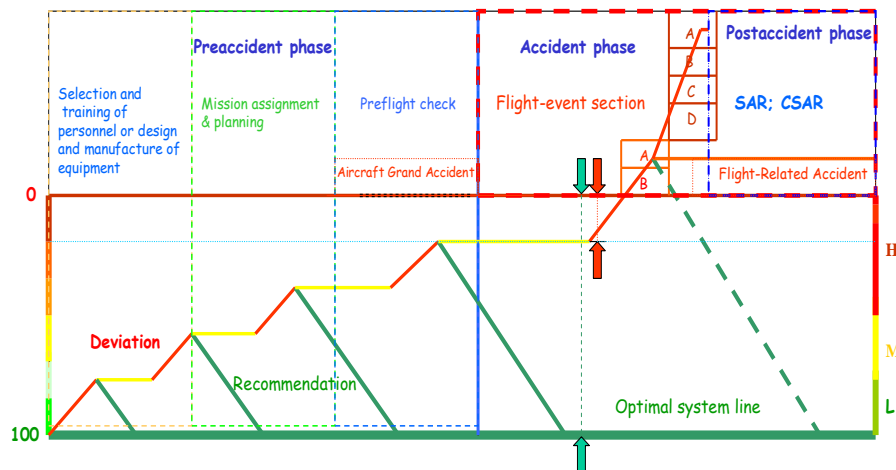

Fig. 4.

The diagram is a 4W” system approach of the accident investigation. On it has shown definitions, system deviations (findings), recommendations, type of accidents and all phases of the system. On the left site is a special scale (from 0 to 100%) showing a capability of the pilot to realize conflict situation, make a decision and clear danger away.

When it close to 100% it means that the pilot has a good chance to clear danger away. When it close to 0% it is most likely that accident will occurs.

The diagrams right side has shown the risk level scale. Close to the Optimal System Line the risk level is “LOW”. When system inadequacies (deviations) had summarized the risk level will be “HIGH”. The pilot, who took off with a huge amount of deviation behind him, could be sure, that hi will cross the flight event sections border, and the flight occurrence will occur.

<sup>9</sup> Aviation Accident Investigation, Student Handout, US Army Safety Center, Fort Rucker, Alabama, May 1996. Page 16.

The reasons people make errors, material fails, environmental conditions contribute, or injuries occur in an accident are the keys to accident prevention. The rationale behind this premise is that if the reasons (system inadequacy (ies)) can be dealt with effectively, then the probability of similar deficiencies causing future accidents or injuries can be reduced.

**PUBLICATIONS**

- [1] Aviation Accident Investigation, Student Handout, US Army Safety Center, Fort Rucker, Alabama, May 1996.
- [2] Army Accident Investigation and Reporting, Headquarters Department of the Army, Washington, DC, November 1994,

Pavel Grecman

## **UTILIZATION OF SELF-PROTECT SYSTEMS ON RECENT HELICOPTERS USED BY CZECH AIR FORCE**

### **INTRODUCTION**

Systems of self protection have the important case in the armed services on the world. With the continual advances in radar technology and the increasing complexity of aerial combat, the effectiveness systems of self protection must increasing too. But systems of self protection used by Czech Air Force (CAF) are behind the times by their technology and their concept. That equipment was developed mostly based upon the experiences from the Soviet war in Afghanistan and now with respect to interoperability in frame of NATO and character of probable treats in assumed missions are applicable with really extensive limitation.

Analyze of current state gives requests to apply modern self-protect systems only to two types of helicopters used by CAF. First of them is the multi-role helicopter Mi-17 that is mainly intended for transport of persons or cargo. Second one is Mi-24, the combat helicopter that is proposed for missions including direct air support, antitank attack, armed escort, air to air combat and reconnaissance as well as to transport troops or serving for SAR tasks.

Recent equipment of both of these types of helicopters for self protection is not sufficient enough to be used under current conditions (requests are to be equipped by autonomous RWR and CMDS). Hardware realization of most of the used warning receivers does not give us the possibility to modernize them or to extend their data library. They have not a capability to record data from mission and after the end of the mission a possibility to evaluate these data by specialists. Next serious shortcoming of those warning receivers is missing direct connection between them and CMDS.

### **THE TASK OF RWR IN FRAME OF INTEGRATED SELF PROTECTION SYSTEM**

The modern self protection system is fully autonomous and achieves the protection against infra-red and/or radar guided missiles. The self protection equipment is

completely integrated into the avionics system, operates in the automatic, semiautomatic and manual modes and is able to launch highly effective RF passive countermeasure CHAFF and IF decoys FLARE in any combination. System is continually monitoring data from the sensors and when threat appears is activating appropriate countermeasure according to preprogrammed sequence.

The system is controlled by keypad and proper switches on the control display unit (CDU) and on the system HOCAS (Hands On Collective And Stick). Visual indication of the system activity is displayed by CDU. There is also possibility to generate voice messages for crew.

### **The radar warning receiver**

Most of the recent NATO's aircraft are equipped by radar warning receivers (RWR). RWR is a part of the self protection system, which immediately informs crew about radar threats, about that fact the aircraft was illuminated by enemy radar. Of course the information about character and type of the enemy radar is available. RWR makes possible to react on the threat and to provide countermeasures by maneuvering or by using of self-protection equipment. Modern digital RWRs are able to detect also composite signal and its source. Acquired parameters and spectral characteristics of the signal are compared to stored patterns from the database. Usually only parts of seconds are necessary to recognize and identify the threat.

The development is oriented to improve sensitivity and angle accuracy as well as the speed of processing. About only two pulses are enough to detect pulse composite signal. There is possibility to detect CW signal too. Most of the RWRs uses VHSIC (Very High Speed Integrated Circuits) or MIMIC (Microwave/Millimeter Wave Monolithic Integrated Circuit) technologies. Extra attention is dedicated to detect signals with low probability of detection LPI (Low Probability of Intercept).

RWRs cover entire frequency band used by main type of radars and are characterized by the huge capacity of data processing in the environment of high density of signals (the ability to process more several millions of pulses per second) and short time of reaction. There are several requests those RWR has to fit:

- to process each radar pulse,
- to adapt itself according to the environment, large number of radar types and to their modes of operation,
- to measure carriage and repetition frequencies of the received signals and to identify their sources by using the receiver IFM (Instantaneous Frequency Measurement),

— the reaction time has to be extremely short in relation to the tactical situation.

The oldest type of RWR is the wideband crystal video receiver (CVR) which does not measure the frequency. They separate signals according to the approximate direction there are coming from and by comparing of the amplitude. The radar type identification is provided based upon the measuring of the pulse duration and repetition rate or PRI (Pulse Repetition Interval). These parameters can be distorted by the environment influence. That is why this method of identification gives ambiguous results.

Next type is the RWR measuring frequency by narrow-band selectivity of input – frequency scanning super heterodyne receiver. The sequence of scanning entire frequency band is too long and reaction is than unacceptable slow particularly when radar is working in the scanning and tracking mode simultaneously (TWS – Track While Scan). Other shortcoming of this type is the dimensions and mass of those receivers.

During the 90's was developed the new generation of RWRs – IFM (Instantaneous Frequency Measurement) designate to use on the planes and helicopters. They use both of the principles, the wideband tuning and coincidental accurate frequency measuring from pulse to pulse.

## RWR USED BY CAF

According to the analysis above current systems used by the Mi-17 and Mi-24 helicopters are not sufficient enough to operate under the expected conditions. The helicopter Mi-17 is equipped by RWR SPO-10 and Mi-24 by SPO-15. Only the RWR Sky Guardian SG-217 which is the part of L-159 ALCA avionics meets the requests described in the previous chapter.

### **Receiver SPO-10**

RWR SPO-10 is intended to warn pilot about the aircraft is illuminated by radar of another fighter. Signalization is by sound signal in the pilot's headphones and optical by appropriate light.

### **Receiver SPO-15**

RWR SPO-15 is intended to locate radars which illuminate the aircraft and to recognize type and mode of these radars. Power of received signals is measured



according to time of arrival into the illuminated area. When the aircraft is illuminated from more directions the indicator indicates only the strongest signal. When safety limits of illuminated signals are over then a red circle gradually lights up and warning tones comes into the pilots headphones. These warning lights and tones are used for pilots to signalize the aircraft illumination. Signalization is activated after the radar localization. That is provided for an aircraft safety. SPO-15 determinates the bearing (accurately from frontal side and approximately from rear side), repetition frequency, carrier frequency (for CW signals) and pulse repetition interval. The main radar and velocity rate are selected by SPO-15. A pilot can choose correct maneuver to escape from territory of risk.

## **Receiver Sky Guardian 217**

Sky Guardian 217 RWR (Fig. 1.) is primarily designed to identify hostile radars illuminating the aircraft in which the system is installed. It identifies threats originating from both CW and pulsed emitters and covers 360° of azimuth in the following bands of the Electronic Countermeasures (ECM) spectrum:

- E/H band – E, F, G and H threat bands, treated as a single band in the frequency range of 2.0 GHz to 7.5 GHz.
- I band – covers the frequencies 7.5 GHz to 11.5 GHz.
- J band – covers the frequencies 11.5 GHz to 18 GHz.

The RWR operating mode is controlled by the operator so that the aircrew is supplied with audio/visual information as follows:

- The bearing of emitters relative to the aircraft.
- The relative RF amplitude of the radar signal for pulse emitters.
- The threat identification of emitters if matched against the built-in emitter library.
- The PRF and band identify of detected unknown emitters.
- True PRF tones for pulse emitters.
- Alarm tones if one or more emitters are confirmed as a threat. There are separate tones for CW and pulse threats.

The system contains an extensive processing capability for analysis and identification of detected emitters. A threat identification library containing known radar signal details may be loaded into the system prior to flight. This is capable of holding data on over 330 emitters, with an average of four modes per emitter. Typical data would include details of frequency band, Pulse Repetition Interval (PRI), priority, stale-out time and a 3-character emitter identify code.

Emitters are presented on the Display using alpha-numeric identifiers superimposed on a pseudo plan view. The system can also initiate electronic counter measures and chaff/flare dispensing when a threat is detected. The system can operate in 12 different modes selectable from the cockpit. Four of these deal with threat warning signals, five offer the use of built-in test (BIT) routines to ensure that equipment in the system is fully operational, and one operates to load data via the Program Loading Unit. The remaining two are reserved for future use. The operator can also select CW or pulse audio alarms, as well as true PRF tones. The operator can choose to view displayed information on all recognised emitters in tabular or polar formats on the display.

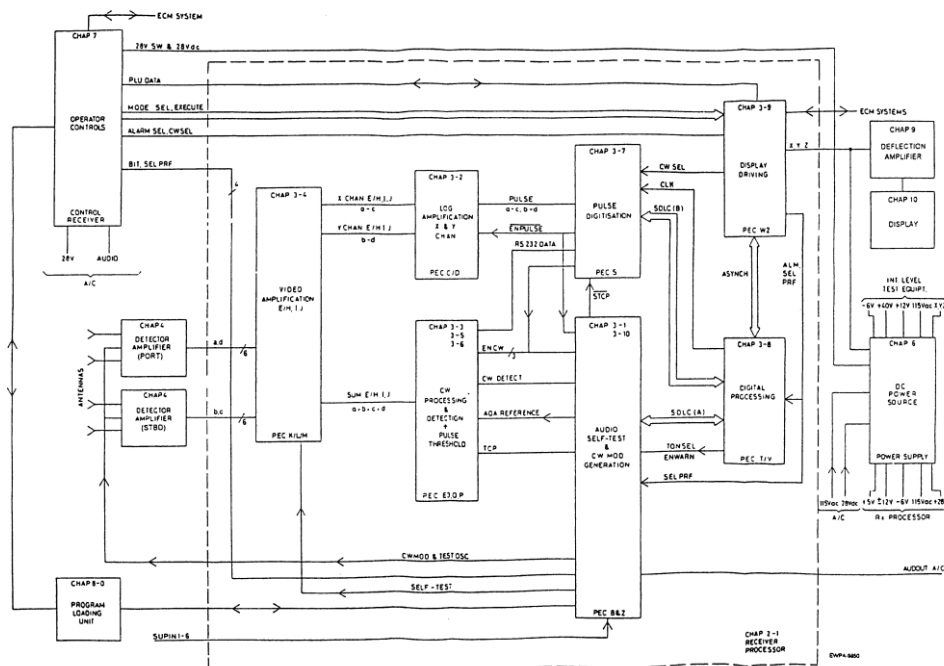

Fig. 1. Sky Guardian 217 (RWR): system block diagram

## THE PERSPECTIVE EVALUATION OF RWR SYSTEMS

The concept of the current RWRs allows them to receive and process signals of the stable source. What is the stable source? That is the source with the constant carriage frequency as well as the constant PRI during the pulse to pulse interval. Recent trend is characterized by coming from the analysis of stable source to the ability to analyze agile sources, which are changing their pulse parameters

continuously. For instance as an agile transmitter can be seen radars specialized for moving target indication (MTI). They use the method of PRF (Pulse Repetition Frequency) jittering. Other examples of agile source are pulse – Doppler radars which are changing carriage frequency and PRF from burst of pulses to burst of pulses or some of adaptive radars with transmitted frequency modulated by given algorithm. Next step of this evolution are the really agile radars which change their carriage frequency and PRF from pulse to pulse randomly. Specific issue in that evolution is that pulse – Doppler radar has to keep constant frequency at least for two adjacent pulses.

Perspective agile radar systems will except of changing carriage frequency and PRF (will be from the range of high PRF) also use pulse compression, adaptive lobe, LPI techniques or continuous wave principle with signal level on the level of noise.

This conglomeration of radar types will cause high density of signals which has to be separated into the effectible data flows in regard of RWR signal processing by both the frequency and spatial filtration. The carriage frequency and PRF are parameters suitable for classification of current sources. For future sources with adaptive and agile character are these parameters completely improper or inapplicable. Generally the incident angle is highly apposite as a classification parameter, since it is impossible to change it by transmitter from pulse to pulse.

#### REFERENCES

- [1] ANDRLE Milos, GRECMAN Pavel, NAIDER Jiri: Approach to the research project, Self-Protection System for Helicopters, 2001. (in Czech).
- [2] CECHAK Jaroslav, ZAJONC Jaromir: Electronic Warfare, Electronic Support Measures, 2000. (in Czech).
- [3] GEC-Marconi: Sky Guardian 217 Radar Warning Receiver for The L-159 Light Multi-role Combat Aircraft, 1998.
- [4] Janes' Radar and Electronic Warfare Systems, 2000 – 2001.

## **NOISE REDUCTION METHODS OF MODERN SINGLE ROTOR HELICOPTERS**

It has been an enormous development since the first practically useable helicopter, VS-300 made by Igor Sikorsky, took off in 1939. At that time their flight performance was very limited but their ability to take off and land vertically and to hover was attractive both for civilians and the militaries. The designers' first aim was to improve this poor flight performance. Although modern helicopters have some limitations, too, but they are very useful in many fields and have become important weapons in the militaries.

Nowadays, a new challenge has appeared for helicopter manufacturers and this challenge is the reduction of emitted noise. It has been well-known for decades that helicopters are noisy devices but growing public sensitivity to helicopter noise and the claim to approach the battlefield as quietly as possible for attack helicopters forced them to be innovative in reducing the measured and perceived external noise levels of their products.

These new noise emission requirements, helicopter manufacturers facing with, have appeared in stricter local and international noise certification standards. Previously, helicopter noise was measured in a simple flyover of a single microphone at 500 feet AGL, regardless of aircraft gross weight. Recently the measurement protocol has also changed and it depends on the gross weight of the helicopter. At present, helicopters over 6,000 pounds gross weight have to pass a series of tests under specific operational and meteorological conditions in take off, flyover and landing mode and the measurement are taken over an array of three microphones. This approach produces an objective measure of aircraft noise. Other variables, such as spatial frequency distribution and frequency of events, are factored into the calculations to provide a subjective value for noise known as Effective Perceived Noise Level (EPNL) and it is measured in EPNdb. Generally speaking, helicopter noise standards of the main aviation authorities, such as Federal Aviation Authority (FAA, United States), Joint Airworthiness Authority (JAA, Europe) and International Civil Aviation Organization (ICAO, a branch of the United Nations) are identical but the new standards expectedly will be stricter and stricter.

## THE MAIN COMPONENTS OF ROTORCRAFT NOISE

Each helicopter has a unique noise signature, but we can say that irrespective of the type of MTR helicopters the main sources of rotorcraft noise are the following [4]:

- The main rotor;
  - High rotor blade tip speed (during high speed flight);
  - Blade-vortex interaction, BVI (during slow speed flight or turn);
- The anti-torque system;
  - The noise of tail rotor;
  - The sound produced by tail rotor blades cutting the main rotor vortices;
- Engine(s) and gearboxes.

In this work I deal with the first two noise emission sources (main rotor and anti-torque system) which have strong connection with the aerodynamics of rotorcraft. To decrease these noises the major manufacturers use a variety of technologies and design solutions including compromises, too.

### Lower tip speed

We have known for decades that the high tip speed makes a lot of noise. At high forward speeds the advancing rotor blade tips ( $\psi = 90^\circ$ , Figure 1. [2]) approach the speed of sound, so the compressibility of air appears with its negative phenomenon (shock waves, vibration and strong impulse noise).

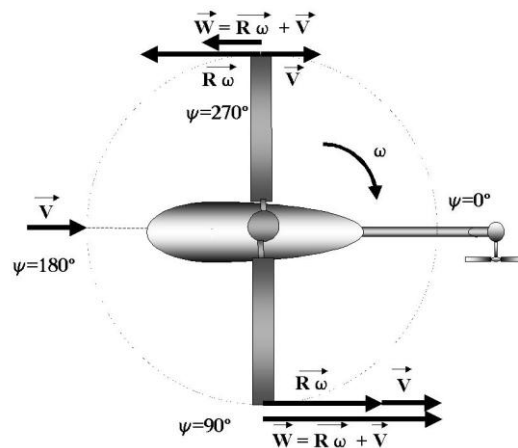

Fig. 1. Resulted tip speeds at  $\psi = 90^\circ$  and  $\psi = 270^\circ$

The development of Bell UH-1 series is a good example for this. Bell UH-1A had a modest rotor tip speed with reasonable noise level. UH-1B got a stronger Lycoming T-53 turbine and the rotor diameter was increased with unchanged rotor RPM. That increment resulted in an advancing tip Mach number of 0,9. Thus the observers on the ground could hear the impulse noise as the helicopter approached from miles away.

If the high tip speed makes the helicopter noisy, then it follows that reduced tip speed results in a quieter helicopter. One solution can be the reduction of rotor RPM. But unfortunately, it is not so simple. At a reduced rotor RPM the size of helicopter envelope will decrease, which means that its maximum rotor thrust, forward speed, payload and flying altitude will also decrease.

Reducing the rotor RPM, but increasing the number of rotor blades the decrement in performance is not as significant as in the first case however assuming unchanged rotor thrust we can expect some disadvantages:

- Reduced allowable payload resulted by the weight of the extra rotor blades;
- Higher required power resulted by the profile drag of extra rotor blades;
- Higher main rotor drive torque, which means higher required power for the tail rotor;
- Reduced maximum forward speed resulted by retreating rotor blade stall.

Despite these disadvantages the use of four or more rotor blades combining lower rotor blade tip speed and blade loading is a feature of nearly all quiet helicopters. We can say that present day new technologies, more sophisticated airfoils, rotor blade shapes, lighter new composite materials balance the above mentioned disadvantages.

An other possibility is the variable rotor RPM. Using rotor RPM governor with two or more settings we can get different rotor RPM-s in accordance with settings, which can be adjusted manually or automatically. For example, using two settings the lower setting would be for flight when the helicopter is near inhabited areas, primarily during take off and landing and other low-altitude operations. The higher setting is for flight situations where noise is less important, such as high altitude cruise or air-to-air combat for military helicopters. Unfortunately, this solution does not totally fit for the operational characteristic of helicopters because the higher performance, rotor thrust (available in case of higher rotor RPM) would be necessary only during take off and landing. Nevertheless, many manufacturers (Eurocopter, MD, Bell) use this device, but we can say that the purposes they want to reach are very different, and, in most cases it is not the noise reduction.

## Swept rotor blade tips and thinner tip airfoils

We know that the negative effects of compressibility (for example, impulse noise) related to the difference of Mach number of the rotor blade tip and its critical Mach number. The nearer the rotor blade tip Mach number approaches its critical Mach number the stronger its noise will be. A way of getting performance advantages of high rotor tip speeds without the noise penalty is to sweep the rotor blade tips. This solution reduces the effective Mach number in the swept region. Generally the outside 7-14% part of blade is swept back by 15-25°, which decreases the effective Mach number in this region by 6-10%.

Another way to minimise compressibility problems is to raise the critical Mach number of rotor blade tip by using thinner airfoils here. This is not a too difficult problem nowadays when most rotor blades are made of composites. The disadvantages of both methods are that they reduce the angle of attack of stall at the retreating rotor blades, and the sweep can cause unwanted aeroelastic couplings.

At present, probably the most sophisticated version of swept rotor blades is the BERP (British Experimental Rotor Program) rotor blade [5]. This strange paddle-shaped rotor blade tip was the product of the ten-year (1976-86) joint project of Westland Helicopters and British Royal Aeronautical Establishment. This shape came from the special sweep they used. They swept the leading edge first forward and then aft (air does not care about the sign of sweep).

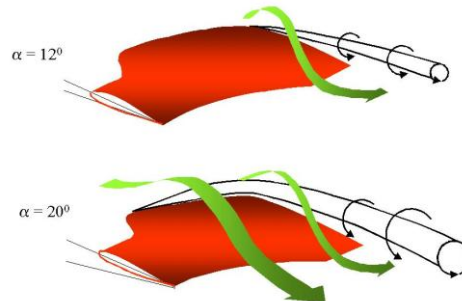

Fig. 2. Tip vortices around the BERP tip

This method could maintain both the tip's aerodynamic center and its center of gravity near the structural axis avoiding the above-mentioned unwanted aeroelastic couplings. In addition this sweep resulted in considerable increment in chord of rotor blade tip, thus it became relatively thinner, further reducing

compressibility effects. But the most surprising was that despite its smaller thickness ratio, BERP tip delayed the retreating tip stall reaching about  $20^\circ$  local angle of attack compared to  $12\text{-}15^\circ$  for conventional tips. This phenomenon was caused by the vortex (Figure 2.), which is generated at the notch of the tip. Proving its abilities a modified Westland Lynx helicopter with this BERP blades achieved a new helicopter speed record of 216.3 knots (400.8 km/h). Now these kinds of rotor blades are used on the Westland Lynx III battle helicopter and EH-101 transport helicopter.

### **Blade-vortex interaction**

Blade vortex interaction (BVI) is what we can hear when the helicopter flies slowly or banks. It is a sharp slap when a rotor blade strikes or just comes too close to the tip vortex left by previous blade [1]. Much effort has gone to understand and reduce this phenomenon with relatively few results. At present the most effective method to diminish this noise is to avoid the combinations of forward speed and rates of ascent or descent at which the helicopter is noisiest. These combinations are found in some flight manuals.

Nowadays some manufacturers are conducting research on active rotor blade control, which can be the most promising device against the BVI. They try to use smart materials, which would change the twist (in this way the angle of incidence) of rotor blades using only electrical impulses. This electrical actuation can change the flight path of the individual rotor blades allowing them to avoid vortex interactions and, in addition, this technology would make it possible to eliminate the mechanical control system.

### **Fenestron (fan-in-fin, fantail)**

Driving the main rotor, by applying power at the rotor shaft, automatically tries to rotate the helicopter's fuselage in the opposite direction of the rotor blades. By far the commonest arrangement is the "main and tail rotor" (MTR) helicopter, in which the main rotor drive torque is counteracted by the tail rotor thrust. Despite the general use of tail rotor it has many disadvantages. For example, vibration, high power requirement, vulnerability, safety problems, and last but not least, high noise emission. Due to the tail rotor's higher RPM the frequency of its noise is much higher than the frequency of main rotor noise. In addition, further noise emission source appears if the tail rotor cuts through tip vortices left by the main rotor. Probably that was the reason why the leading helicopter manufacturers sought new ways to counteract torque. Nowadays two systems replace the conventional tail rotor: fenestron and NOTAR.





Fig. 3. Fenestron of EC-120 and EC-135 helicopters.

The “fenestron” was pioneered by Aerospatiale before it became part of Eurocopter. Later Eurocopter has referred to it as a “fan-in-fin” and Boeing Sikorsky as a “fantail”. Because the blades have very small clearances with the side of the duct, there are essentially no tip vortices and the noise from the blades is at least partially blocked by the duct, thus it should be inherently quieter than a tail rotor. Despite this facts the first versions of fenestron were not totally successful. Although the emitted noise was lower, but on a single dominant high frequency, which made them like a siren. Later Eurocopter on EC-135 (Figure 3.) and subsequent Eurocopter designs made the blade spacing uneven, slanted the supports and reduced the tip speed by 10%. This made a more distributed noise, which is easier on the ears than the shrill sound of the original designs.

### NOTAR helicopters

As I mentioned in the previous chapter the tail rotor with its disadvantages is a necessary evil. Helicopter designers have been working on replacing the tail rotor since the first helicopters left the ground.

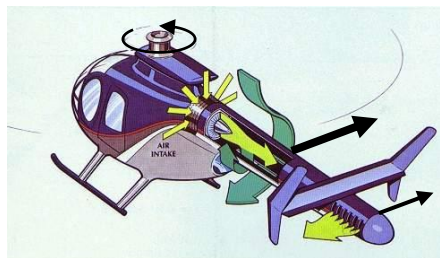

Fig. 4. Scheme of NOTAR system

Although fenestron solved some problems of tail rotors but in the late 1970s then Hughes Helicopters started a new project, which was totally different from the previous methods.

After long tests and some difficulties its successor, McDonnell Douglas could introduce the MD 520N helicopters in 1991. NOTAR means “no tail rotor” and it uses a fan-driven air circulation within the tail boom to counteract the main rotor drive torque (Figure 4.) and to provide the yaw (directional) control of helicopter. Of course, the fan mounted in tail boom is not soundless, but especially at subsequent more sophisticated versions, MD 600N and MD 902 the noise decrement is significant. These NOTAR-equipped helicopters with five and six-bladed main rotor are well below even the most restrictive ICAO noise standards.

## SUMMMARY

Summarising these efforts, we can say that none of them offers fundamental breakthrough. Present day quiet helicopters usually use the variety of above-mentioned solutions and many times designers are forced to pay performance for noise reduction. We can be sure that any manufacturers will not be able to produce an absolutely quiet helicopter, but we can also be sure that manufacturers will do everything possible competing for the favours of their buyers.

### REFERENCES

- [1] DR. POKORÁDI László, BERA József: A helikopterzaj vizsgálata, Haditechnika, 2001/1.
- [2] BÉKÉSI László: Multimédia alkalmazási lehetőségei a helikopter aerodinamika tárgy elsajátítási hatékonyságának növelésében, Repüléstudományi Közlemények, Zrínyi Miklós Nemzetvédelmi Egyetem, 1999. XI. évfolyam 26. szám.
- [3] NAPERT, Greg: NOTAR maintenance – No sweat, Aircraft Maintenance Technology, September. 1999.
- [4] PROUTY, R.W.: Noise reduction is one of the most competitive aspects of helicopter manufacturing, Rotor & Wing, October. 2000.
- [5] PROUTY, R.W.: How good is the BERP tip?, Rotor & Wing, September. 1997.



## PULL-UP FROM A DIVE

### INTRODUCTION

In case of some type of aircraft, like military and acrobatic exists the pull-up from a dive manoeuvre. Pull-up from a dive is a curved line motion in vertical plane, in which an aircraft flying with negative pitch angle is constrained suddenly to fly horizontal or with positive pitch angle under the effect of the elevator. In some cases at pull-up from a dive, the loading factor can be higher than the loading factor associated to physiology or to aircraft structure. At the same time, an aircraft flying with given velocity can not make pull-up from a dive under a minimal altitude.

In this paper it is presented the analysis of the minimal altitude (in function of the entrance velocity in pull-up from a dive manoeuvre), which assures security according with the restriction factors.

The analysis was made especially for an UAV, called IAR-T, which was designed and built by the Romanian National Institute for Aerospace Research “Elie Carafoli” (INCAS).



Fig. 1. IAR-T

IAR-T has the following main characteristics:

Length: 1,82 m	Highness: 0,6175 m
Wing area: 0,91 m <sup>2</sup>	Wing span: 2,6 m
Mass: 15 kg	Power of engine: 4,1 HP
Range of speed: 14-44 m/s	
Loading factors: $n_x=5-6$ , $n_y=2-3$ , $-1 < n_z < 2$	

## THE EQUATIONS OF MOTION

The simulations are based on the nonlinear equations of longitudinal motion of the aircraft, which are the following:

$$\left\{ \begin{array}{l} \dot{V} = \frac{1}{m} [(F_x + T) \cos \alpha + F_z \sin \alpha] \\ \dot{\alpha} = q - \frac{1}{mV} [(F_x + T) \sin \alpha - F_z \cos \alpha] \\ \dot{q} = \frac{1}{J_y} (m_y + T \cdot z_T) \\ \dot{\Theta} = q \\ \dot{x}_n = V \cos(\alpha - \Theta) \\ \dot{z}_n = V \sin(\alpha - \Theta) \end{array} \right. \quad (1)$$

The forces and the pitching moment are expressed by:

$$\begin{aligned} F_x &= k(C_L \sin \alpha - C_D \cos \alpha) - G \sin \Theta \\ F_z &= -k(C_D \sin \alpha + C_L \cos \alpha) + G \cos \Theta \\ m_y &= kcC_m \end{aligned} \quad (2)$$

where  $k = \frac{1}{2} \rho V^2 S$ ,  $\rho = \rho(z_n)$  and “c” means the wing chord.

The aerodynamics coefficients are given by:

$$\begin{aligned} C_L(\alpha, q, \delta_e) &= C_{L_0} + C_L^\alpha \alpha + C_L^q q + C_L^{\delta_e} \delta_e \\ C_D(\alpha, \delta_e) &= C_{D_0} + C_D^\alpha \alpha + C_D^{\delta_e} \delta_e \\ C_m(\alpha, q, \delta_e) &= C_{m_0} + C_m^\alpha \alpha + C_m^q q + C_m^{\delta_e} \delta_e \end{aligned} \quad (3)$$

Introducing these expressions of forces and of pitching moment in system (1) and separating the fifth equation from it, the final system of simulation will be:

$$\left\{ \begin{array}{l} \dot{V} = [-kcC_D + T \cos \alpha - G \sin(\Theta - \alpha)]/m \\ \dot{\alpha} = [mVq - kcC_L - T \sin \alpha + G \cos(\Theta - \alpha)]/mV \\ \dot{q} = (kcC_m + T \cdot z_T)/J_y \\ \dot{\Theta} = q \\ \dot{z}_n = V \sin(\alpha - \Theta) \end{array} \right. \quad (4)$$

## PULL-UP FROM A DIVE MANOEUVRE

It will be consider, that before the pull-up from a dive manoeuvre the aircraft is in free fall with  $\Theta = -\pi/2$ . In this paper it is not analyzed how can arrive the aircraft in this position. The stabilized value of state and control variables in free fall, can be calculate using the first four equations of system (4) in which, the left side will be zero, expect the first equation in which the left side will be equal with the gravitational acceleration (g).

$$\begin{cases} T \cos \alpha + G \cos \alpha - kC_D - mg = 0 \\ T \sin \alpha + G \sin \alpha + kC_L = 0 \\ T \cdot z_T + kcC_m = 0 \end{cases} \quad (5)$$

Solving this system, results the stabilized value for  $T, \alpha, \delta_e$  at the beginning of the pull-up manoeuvre. In this manoeuvre the elevator will have a linear variation in function of the time ( $\dot{\delta}_e = \text{constant}$ ) and the block structure is presented on fig. 2. The manoeuvre will be finished and will be continue with horizontal flying when the pitch angle becomes positive.

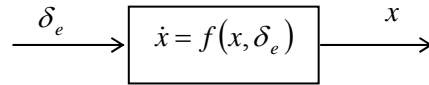

Fig. 2. The block structure of control system in pull-up manoeuvre

## FLYING AFTER THE PULL-UP

If the purpose is to fly horizontal after the pull-up manoeuvre, this equation will be used for the motion of elevator:

$$\delta_e = -k_z(z_{npr} - z_n) - k_\Theta(\Theta_{pr} - \Theta) \quad (6)$$

The programmed pitch angle  $\Theta_{pr} = 0$  and the programmed altitude  $z_{npr}$  will be approximately the altitude where the aircraft arrived after the pull-up. In this case the simplified block structure of system control is presented on fig. 3. and the coefficients  $k_z, k_\Theta$  will be determined using the linearized longitudinal model and the method of the standard coefficients [1].

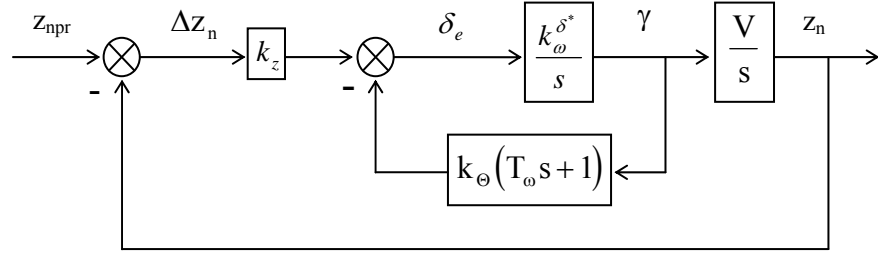

Fig. 3. Simplified block structure of longitudinal motion with the control of linear and angular deviation

The transfer function of the control system is given by:

$$H(s) = \frac{\frac{k_z k_\omega^{\delta^*} V}{1 + T_\omega k_\theta k_\omega^{\delta^*}}}{s^2 + \frac{k_\theta k_\omega^{\delta^*}}{1 + T_\omega k_\theta k_\omega^{\delta^*}} s + \frac{k_z k_\omega^{\delta^*} V}{1 + T_\omega k_\theta k_\omega^{\delta^*}}} \quad (7)$$

and the corresponding standard transfer function is:

$$H_0(s) = \frac{\Omega_0^2}{s^2 + 1,5\Omega_0 s + \Omega_0^2} \quad (8)$$

The coefficients  $k_z$  and  $k_\theta$  could be calculated on the base of the identification between this two transfer function:

$$k_z = \frac{\Omega_0^2}{V k_\omega^{\delta^*} (1 - 1,5 T_\omega \Omega_0)} \quad k_\theta = \frac{1,5 \Omega_0}{k_\omega^{\delta^*} (1 - 1,5 T_\omega \Omega_0)} \quad (9)$$

where

$$k_\omega^{\delta^*} = \frac{k_\omega^\delta}{1 + k_\omega^\delta k_\delta^q} \quad (10)$$

$$k_\delta^q = \frac{1,5 T}{k_\omega^\delta T_\omega} \left[ \left( \frac{1,5 T}{2 T_\omega} - \frac{2\xi}{1,5} \right) + \sqrt{1 + \frac{1,5^2 T^2}{4 T_\omega^2} - 2\xi \frac{T}{T_\omega}} \right] \quad (11)$$

Other notations used in the above mentioned expressions:

- own frequency of the standard system ( $\Omega_0$ );
- the inverse of the own frequency of system ( $T$ );

- advance time in pitching command ( $T_\omega$ );
- command factor of pitching ( $k_\omega^\delta$ );
- relative pitching damping factor ( $\xi$ );

## RESULTS AND CONCLUSIONS

With simulations were determined at three entrance velocity (20, 40, 60 m/s), the minimal entrance altitude which still permits to the control system the execution of the pull-up manoeuvre above 100 m altitude.

The results are presented on fig. 4. – fig. 8. From its is visible, that the state and control variables have a good damping factor and they are in concordance with the expected results. With more simulations it is possible to construct a range for minimal entrance altitude in function of entrance velocity, in which the pull-up manoeuvre is executable in security.

On fig. 7 it is observable, that the velocity of motion of the elevator depends at least on the entrance velocity and the next step of this work can be the determination of this dependence. This means to close the control system in fig. 2.

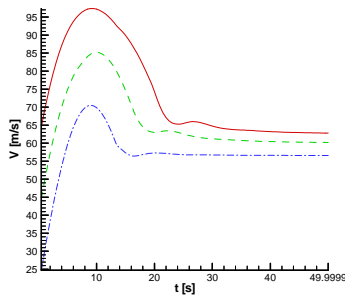

Fig. 4. Velocity

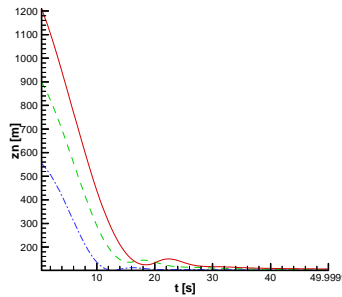

Fig. 5. Altitude

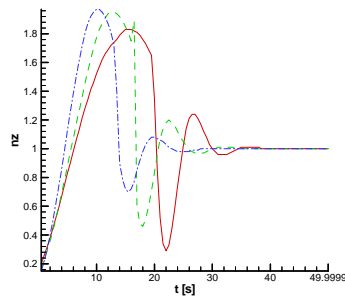

Fig. 6. Loading factor

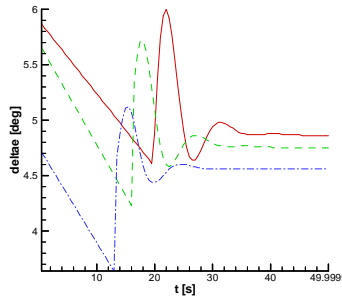

Fig. 7. Motion of the elevator



## REFERENCES

- [1] CHELARU, T. V.: Concepte de proiectare a avionului fără pilot. Uzina Electromecanică Ploiești, 1998.
- [2] ETKIN, B.: Dynamics of Atmospheric Flight. John Wiley & Sons, Inc., New York, 1972.
- [3] ETKIN, B. and REID, L. D.: Dynamics of Flight -Stability and Control. John Wiley & Sons, Inc., Toronto, 1996.
- [4] INCAS: Concepție generală model IAR-T. Cod: C-2035, DT. 108/15.03.1998.
- [5] INCAS: Analiza aerodinamică a modelului IAR-T. Cod: C-2054, DT. 131/25.04.1998.
- [6] MACIEJOWSKI, J.M.: Multivariable Feedback Design. Addison-Wesley Publishers Ltd., 1989.
- [7] MCLEAN, D.: Automatic Flight Control Systems. Prentice Hall, London, 1990.
- [8] NELSON, R. C.: Flight Stability and Automatic Control. Prentice Hall, London, 1998.
- [9] Web page: [www.incas.ro](http://www.incas.ro)

## **EXPERIENCES OF COMMAND SERGEANT MAJOR (CSM) COURSE IN THE AIR FORCE**

### **THE NEED OF ORGANISING COURSES**

Joining the NATO on the 12 of March 1999 meant a decisive change for Hungarian Army. The inherited constitutional structure and military skills couldn't be fitted to the structural system of the NATO. A strategic revision, which was needed to the reorganising of the Hungarian Army — and within it the Air Force — was fulfilled in 1999. As the result of the strategic assessment, among others, Command Sergeant Major (CSM) assignment appeared on establishment tables in the Air Force, too. The authorisation of these assignments was explained by the fact, that the authority, the right, the responsibility and tasks of commissioned and non-commissioned officers were different in the forces of the NATO and in Hungarian Army. The role of non-commissioned officers „is aimed at efficient professional operating, handling, maintenance and repairing of military objects and leading of small subunits”. (1)

In 2000, CSM assignments were accomplished, as the top of the career of non-commissioned officers, to be of assistance to subunit leaders in executing their tasks. The aim was to be able to help leaders and increase the preparedness of the subunit to execute different tasks in peacetime, threat or in wartime. However, unit leaders didn't know these assignments, its content and the order of their work. Only those leaders could know about it who had studied abroad before and had met officers in this assignments – but there were only a few commanders of this sort. However, in the Air Force a need arose for establishing CSM courses that the newly appointed non-commissioned officers could acquire the professional tasks of the new assignment after positioning in assignment. There hadn't been a possibility for it before because of the immediate changes.

### **CIRCUMSTANCES OF THE COURSE LAUNCHING**

From 1997 the Air Force Refresher Department had been executing a NATO-orientate preparation for the Air Force commissioned and non-commissioned officers. The General Staff of the Air Force asked this Department to prepare CSM-s, because it had had some experiences in NATO preparation. In the Air Force Refresher Department there were 2 teacher-officers who had met abroad non-commissioned officers in this assignment in different courses and they had

some ideas about these non-commissioned officers' activity. That's why the leaders of the Department got in touch with „CUBIC” team in Budapest, where there was an American non-commissioned officer who had been working in this assignment for years. He had a lot of experiences and he wrote down them in „Honvéd Altiszti Folyóirat” periodical. The Department contacted other Air Force commissioned and non-commissioned officers who had studied abroad and had seen the command CSM-s to work. The department received some documents in Hungarian and in English about this assignment (3-7) that they treated in „autodidactically” and tried to insert in the atmosphere of the Hungarian Air Force. During working out the program of subjects and topics there was a problem: „there were nothing to base on”, because most of the non-commissioned officers coming to schooling didn't know the operational procedures, the requirements of NATO interoperability and compatibility which were fixed in NATO STANAG-s. That's why the wide scale of subjects appeared. The compositor team attached to it the task system of CSM. The set-up of instructor team came with some difficulties, because also staff members had been averse to this new assignment and „not everybody saw the future in it”. The time for working out was limited and reducing of the period of the course – because of limited available funds and reducing of the time that the non-commissioned officers had spent away from their family- was necessary.

## CONTENTS AND STRUCTURE OF THE FIRST COURSE

6 weeks and 204 classes were available for the training. In initial period the different authority, responsibility and tasks of commissioned and non-commissioned officers came to the front of the training.

During the course students could get to know: military leadership style, process of becoming leader, leadership counselling, communication and meta-communication, different methods of leadership, NATO leadership, team-work, the task-system of the training, preparation in NATO, training program for subunit leaders, NATO conventional signals, crisis management procedures, acts, rules, HAGUE-GENEVA Conventions which are operative for personals of Hungarian Army, NATO regulations of environmental and fire protection, leader's responsibilities and tasks, order of command, preparation and fulfil duties, NATO UTM and MGRS systems, rules of using military maps, signal communication in English, tasks of technical and NBC support and the role of CSM's in these tasks, rules of assignment take-over, NATO logistics, reception of delegations and guests, within knowing manuals they could know the tasks, role and position of CSM, structure and apply of supporting teams.

During the course students acquired the tasks of CSM with the assistance of battalion support program, reception of the newly arrivals, family-, drug-, alcohol-.physical state-, mental – and keeping of career programs, evaluation of non-commissioned officers, providing of allowances and applying NATO documents.

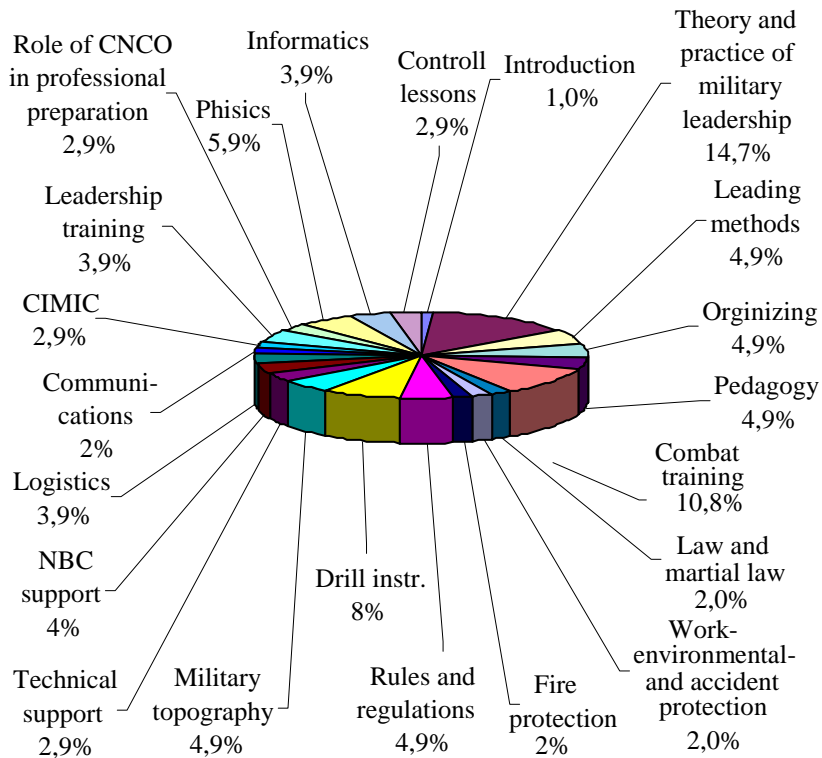

Fig. 1. Division of CSM's course subjects in 2000

During the course students became to be able to: make working plans, conduct discussions, meetings, solve military-professional problems with some assistance, keep the training-register and educational documents, give orders to conduct military formations, prepare for fulfil duties, using of conventional signals and maps, prepare for some survival procedures, some minimal information science activity. Their endurance and shooting skills were increased.

## FORMS, CONTENTS AND EXPERIENCES OF EXAMINING

Testing level of knowledge in the course had happened by 10-12 minutes oral and written exams, tests, fulfilling documents and working with maps in the

beginning of every lesson. These all things were contributed to passing the exam. During lessons and exams it came to the light that „students” didn’t get used to the desks and tests. The Commander of the 89<sup>th</sup> Mixed Air Transportation Regiment – on behalf of the General Staff of the Air Force- was the chairman of the examiners. There were a lot of subjects so it was needed to initiate the instructors of the different subjects into the board of examiners. The commander made an effort to get to know how could the students apply their knowledge in the real life. The students had to work with documents or maps in the theoretical examination, respectively during practical exams in drill field they had to solve practical tasks. The students got a charter after successful examination. First experiences showed that there had been some non-commissioned officers with just a few experiences who could understand with difficulty the substance of their assignment and it was showed by there results, too. In these cases it would be more practical to do a NATO integration course before this course because some non-commissioned officers could hardly leave the „executive” style and work in „leader-controller” style.

## BASIC EXPERIENCES OF THE FIRST COURSE

The Air Force Refresher Department started course for Air Force CSM-s first in the Hungarian Army. It was an effective assistance that 3 persons from the 'CUBIC' work-team – they were non-commissioned officers in the USA, one of them was a CSM – gave a 6-hour lecture on CSM system in the USA, how they solve their tasks. Before the performance the students had sent 21 questions to the work-team (about the training, preparation for fulfil the assignment, organising the reinforcements, qualification requirements, relationship among the CSM’s of regiments, battalions and companies, relationship between commanders and CSM-s, how they help commanders in their work, how often hold they a meeting, about motivation, relationship between men and women in the army etc.) The work-team answered these questions. The bright spot of the course was that 2 women had been taking part in the course.

The requirements of the assignment and separation of tasks – in the education-provided logical knowledge for the students. Considering the experiences during the course and the suggestions of the 'CUBIC' work-team, it became necessary to redraft the thematic and work out the creed of Air Force non-commissioned officers for the further courses. The next years work was affected by the fact that the CSM of the General Staff of the Air Force had studied in the first group.

Creed of the Air Force CSM-s: (8)

*I am the Command non-commissioned Officer of the Hungarian Air Force, **leader** of people and **counsellor** of my direct superior. I am proud of being NCO in the*

*Air Force and I make every effort to reflect it in my appearance, behaviour and work. I will never abuse my authority. Among the Air Force NCO-s **I am the best NCO** of the unit. I am professional in thinking and working, and I do my best to popularise the Air Force. I make an effort to gain the trust of my superiors and subordinates. I set a good example in conducting, counselling, teaching, assistance, appearance and behaviour. I always fulfil my responsibilities excellently because **I am a professional NCO**. I always train on my own, perfect my theoretical and practical knowledge. I am stimulating, initiative and many-sided in carrying out tasks. I know my subordinates perfectly and employ their knowledge and skills maximally. I can understand the subordinates' problems and I take care of them. I always enquire about the unit's activity and use the possibility provided by the information. I give well-founded and right advises to my superiors for fulfilling their tasks. I obtain their appreciation with my work. I maximally support and fulfil the orders of the superiors **in accordance with the regulations**. I have got many years theoretical knowledge and practical experiences and well-founded value judgement. In lack of orders I always initiative. I don't distinguish people according to their age, colour, religion or national origin. I haven't got prejudices. I demand so much as much as I could do. I am honest, fair and brave. **I meet the requirements**. I never forget my leading role because **I know that I am the CSM of the Air Force**.*

The words of this creed contain everything, which is the essence of this assignment. The second group was averse to it a little bit because it hadn't been typical before. It was strange for them that the knowledge, awareness, confidence and vocation- and the fact that they are the best in the unit – are accompanied by spoken and demonstrated pride.

## DEVELOPMENT OF THE COURSE, EXPERIENCES OF THE SECOND COURSE

In 2001 the Air Force Refresher Department in Szolnok, Air Officers' Institute, had started the second CSM course. The available funds provided 6 weeks-208 lessons again. There were some changes in thematic and the subjects. We planned 4 lessons for CSM assignment requirements created by the General Staff of Air Force. We increased the number of leadership, pedagogy to 66, we separated the tasks of CSM, and we planned 2-2 lessons for management and protection of secrets, disaster relief, survival training, personnel management, finance and 6 lessons for visiting the Museum Military History. In every lessons in the second 10-15 minutes a student gave a lecture - after the teacher prepared him – on the new topic. So he could practice the tasks of a teacher, the using of educational aids and rhetoric. The students could practice in practical lessons as

instructors. We provided possibility for performances of the “CUBIC” work-team again. In the last third part of the course a CSM of the Air Force and 2 other CSM-s from other units – they had been taking part in the first course – gave lectures. They told how CSM-s worked in real life in the last one year, what their instructions were for the newly finished CSM-s.

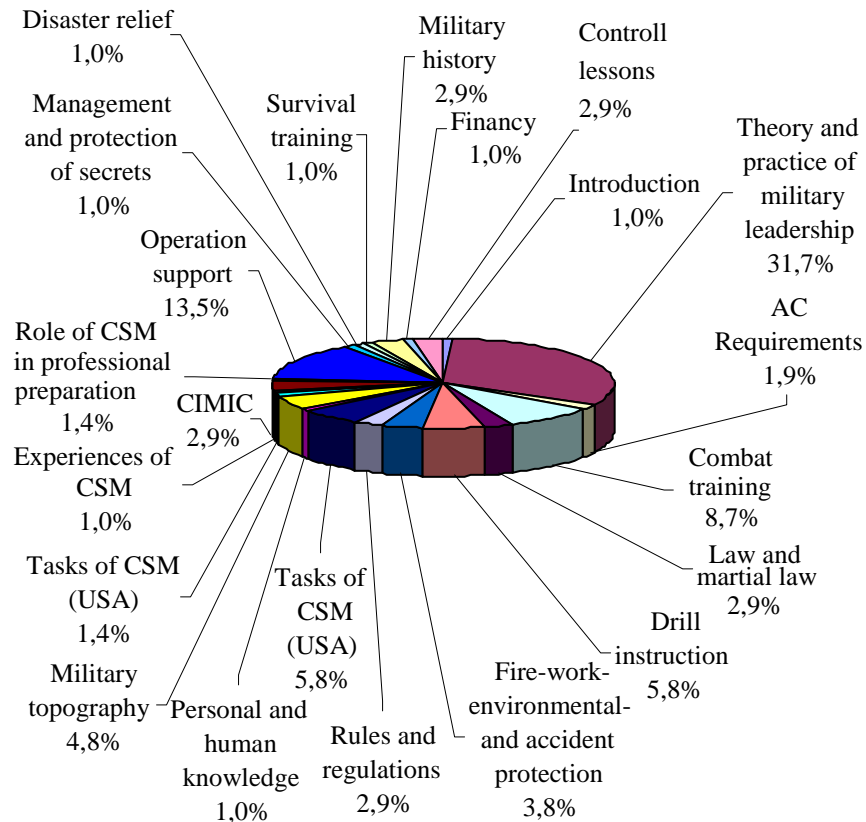

Fig. 2. Subjects of CSM course from 2001

## INDIVIDUAL REASONS, MOTIVATION, PR ACTIVITY

The students of the first course carried out an order when came to the course, they didn't know what its essence was, so their behaviour corresponded to the behaviour of “necessary bad”. However during the course it was successful to arouse their interest and make them understand the need of accomplishing the course. The students' aptitude had positively changed from the second week. The extensive interest with which the students received the performance of the

“CUBIC” work team showed the progress of being active. The 80% of the second group were voluntary – their interest and activity was higher from the first week. Some photos had been taken about both groups – these pictures can be seen at present in the corridor of the Aviation Technical Institute Air Force Operations Support Department (the formal Air Force Refresher Department). The ‘Szolnoki Néplap’, the ‘Magyar Honvéd’ and the ‘Honvéd Altiszti Folyóirat’, ‘Szolnok Rádió’, ‘Rádió 2000’ and ‘Szolnok TV’ reported about the courses. Its result was that some CSM-s from the subunits of the Hungarian Army Staff were interested in the course. It was typical that students organised some programs after the classes, so students’ connection became stronger.

## EXISTENT PROBLEMS AND SOLVING ALTERNATIVES

In some subunits it means a problem for the CSM-s — in the future too — to fulfil assignment duties because a part of commissioned and non-commissioned officers — because lack of information — regard advises for superiors or an interest in health, physical state or family, as a needless bothering. Commanders should be aware that the CSM-s could free them from a lot of work if the commander trusted them. The CSM can make the preparation of decision easier with providing real information and well-founded advises for the commanders. NCO-s should be aware that there is a CSM assignment and CSM-s’ tasks are to have all the information about the other NCO-s of the subunit. With the information they can effectively help soldiers or represent them.

The change at subunit/unit level, which was so intense as the result of the continuous reorganising, made the CSM-s’ work more difficult. Because of the outflow of people, the process of knowing staff thoroughly is slower than before. It is difficult to find young CSM-s because the base for motivation is missed: the name, the rights, the influence, the responsibilities and tasks are not fixed in the regulation of the military service. Special non-commissioned officers don’t want to accept the assignment because they lose the health-, classify- and hazard bonuses and meal allowances. The CSM-s haven’t got leader bonus and extra leave. A lot of inexperienced young enrolled for the first course. Some of them hadn’t been able to meet the requirements and they didn’t accept the assignment in the future. It should be more practical to appoint the most fitted, the most experienced persons CSM-s. Most of the CSM-s don’t get into those boards where decisions are taken in relation with the CSM-s. It is needed to change to be effective. It should be practical if the CSM took part in the personal interviews of the unit in those cases when a NCO is concerned.



To this, regulation of military service should be changed: the CSM should be the superior of the unit's NCO-s and other soldiers without rank. The names of CSM — at the levels of brigade, regiment, battalion, company and platoon —, the tasks, responsibilities should be fixed. There is no contact between NCO schools and the CSM-s — but there is a good example for the opposite case: the contact with the Air Force Refresher Department is excellent. It hasn't been clarified yet what duties a CSM has to fulfil — it needs central orders.

It is often a problem that the theory and practice of military organising learned in the course are different from applying it in the real life. Its solution is the responsibility of unit commanders on the base of CSMs' advises. In the further courses it should be handled more stressed to teach methods of organising, problem – solving, military politeness, wearing uniform, fostering traditions, rules and regulations and acts. The HM 30/2001-decree (9) fixed the CSM assignments in the Air Force and provided to appoint the most experienced NCO-s CSM-s.

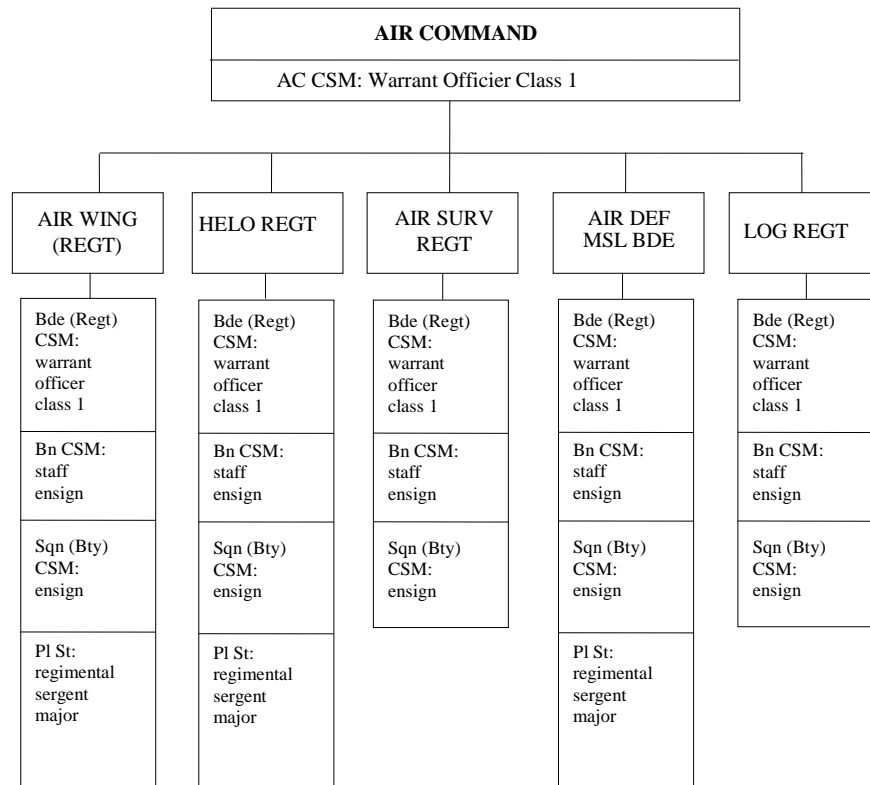

Fig. 3. System of CSM assignments in the Air Force

## THE FUTURE OF THE COURSES

The CSM-s in the USA are acquiring the theoretical and practical knowledge of the assignment during a 6-month or one-year courses. For the Air Force CSM-s at least a 4-6-month course could provide the effective fulfil of the assignment. However, before it the anomalies came from inexperience, offences, “neglect” — should be tightened up. The Air Force Operations Support Department is prepared; it worked out the 4-month program of the company-CSM course. The CSM-s of the Air Force Command should be prepared in the USA CSM-schools. The future is based on the NCO-s in the Air Force, too: we can provide — with a high standard education — real CSM-s for the units’, subunits’ NCO-s.

### REFERENCES

- [1] CUBIC Applications, Inc.: The Roles and Missions of the Sergeant Major and the Command Sergeant Major – a summary – 03.10.2001.
- [2] Ted L. Weekley: Az amerikai hadsereg vezénylő tiszthelyettese – Honvéd Altiszti Folyóirat –2001/1.
- [3] US Army Sergeants Major Academy: CSM (D) Training Packet. Texas, 1988.
- [4] FM 22-600-20: The Army Non-commissioned Officer Guide. Washington, 1986.
- [5] US Army: US Army Non-commissioned Officer Professional Development Guide. Washington, 1987.
- [6] TC 22-6: The Army Non-commissioned Officer Guide. Washington, 1990.
- [7] Pamphlet 600-32: Leader Development for the Total Army. Washington, 1991.
- [8] written on the base of a Creed of a USA NCO – the author.
- [9] Honvédelmi Miniszter 30/2001. HM rendelete. Budapest, 2001.



## **USING OF THE DATA OUTPUT OF THE MODERNIZED PRECISION APPROACH RADAR FOR AIRCRAFT NAVIGATION**

### **INTRODUCTION**

The demands of the common navigation are well protected during the En-route by the standard navigational means and systems at the presents, if needs by the Standard Positioning Service (SPS) of the Global Positioning System (GPS). It is impossible to provide the accepted requirements of the International Civil Aviation Organization (ICAO) and the plan of the European Organization for the Safety of Air Navigation Operations (EUROCONTROL) in connection of the creating conditions for the Free Routes and for the Reduced Vertical Separation Minimum (RVSM) by these standard means for the future.

The demands for the accuracy of the navigation during the Approach are much higher then for the navigation during the En-Route and they are guaranteed by the navigation systems Instrument Landing System (ILS) and Precision Approach Radar (PAR) — for the Precise Approach. These Systems have got high demands to the installation of the land — based subsystem and they are very expensive at the present.

It is impossible to provide the requirements of the navigation by means of the common systems in the case of emergency, for example in the case of the forced landing at the alternate airport, the navigation of the Search and Rescue (SAR), under the severe weather conditions, if need by the air-to ground attack. It is impossible to fulfill such high demands for the precise navigation, neither with the application of the Precise Positioning Service (PPS). It is suitable to applicate the technology of the differential GPS for the providing of these demands. This problem is solved within the bounds of the project named a NAVIS (Navigation Information System) in the conditions of the Czech Air Force. The part and parcel of the NAVIS is the DGPS too.

### **CONCEPTION OF THE MNI SYSTEM**

It is important to look for the new sources of the navigation information for other increasing of the reliability and accuracy of the control of the aircraft during the Approach.

There are several alternatives, one of them is the transfer of the data output of the modernized Precision Approach Radar RP-5M on the board, its data processing and indication for the cross track deviation display. The Multinavigation System might be realized by the application of the data navigation PAR together with the output informations ILS and the DGPS, if needed by the other sources of the navigation information (DME, RALT, Encoder). This Multinavigation System makes the choice 1 of 3 systems by the guidance of the aircraft during the Approach: ILS, DGPS, PAR or their optimal processing, with the application of the Kalmann's filtr.

Then it will be possible to realize the Approach by means of up to 3 independent systems — ILS, PAR with the data output and the DGPS at the Air Force base. The realizing of the 2 independent mobile systems — PAR with the data output and the DGPS, which is based on the using of the mobile reference station will be able to have an application at the unpermanent airport.

The output signals all of these 3 Systems might be indicated to the aircrew by the same way on the original ILS indicator. This solution make the realization of the manoeuvre possible by the same way, without regard to the source of the information, by means of the same procedure of the Approach. It will ll make the training of the aircrew easier and it will reduce the demands for the activity of the Air Traffic Control. See the Concept of the MNI Processing and Display on Fig. 1. The MNI System consists of the subsystem DGPS, the source PAR data, the PAR transfer data subsystem, the Data Acquisition Unit and the Control Unit.

## **DGPS Subsystem**

The navigation DGPS Subsystem is determined to the providing of the precision navigation of the advanced aircraft of the Czech Air Force in the En-Route and the precision Approach phases of flight. This System follows the international requirements for the Differential Corrections (DC) and the error control coding. The reliability of the Differential Correction Transfer and the universality of the application of the DGPS Subsystem for the various types of the aircraft is guaranteed by the DC transfer in the 3 independent channels (VHF/UHF, HF /VHF, LF) and by the simultaneous receiving of the DC on from 2 up to 3 channels. The precise navigation information is integrated into the airborne navigation system of the various types of the aircraft. The integrity of the system is guaranteed by its ground monitoring.

The experimental screening of the function of the DGPS System was made in the laboratory conditions at the Military Academy in Brno. The Reference Station and the DC trasmitter were placed in the distance of approx. 200 m from the DC receiver and from the other parts of the airborne segment of the DGPS

navigation system. The verification of the accuracy of the DGPS Subsystem in the static conditions was made on the geodetic point No./fig. 0070 in Brno and the final experimental screening in the dynamic conditions was made on the L-410 FG airplane in the area of the Pardubice Air Force Base in November 1999 and additionally during the flight experiment in October 2000 on the MI-17 SOR helicopter at the Caslav Air Force base.

### **PAR data source**

The PAR data source presents the of the RP-5M Precise Approach Radar, which detected the target's position in 2 surfaces — azimuth and elevation. The measuring data are processing and evaluating as a deviations of the aircraft owing to the Final Approach Segment and after the filtration they are displayed on the indicator.

It is possible to use the evaluating deviations from the final approach segment together with the data refer to the adjusted Final Approach Segment as the data for the transfer for the airborne aircraft. The positions of the target data are transmitted and at the same time it is possible to transmitt the single formalized commands too. These data is necessary to transform into the conventional format of the user message to make possible their processing on aircraft. The given data are transforming twice a second on board by the actual elevation and the azimuth of target position. The „alpha“ mode will make possible the identification of the individual targets during the Approach.

The conventional format of the user message of the PAR data consists of 12 Bytes. The first 3 words form the header of the message, what follows is a message of 8 words of of the PAR data + one-time commands and the message is finished by the check word. The one-time commands are transfered on board with the aim of the making the TOWER – aircrew communication during the Approach and the Landing more effective. The one-time commands must be a nature of the simple orders. The file of the commands should be made by the Air Traffic Control operators. Analogously is defined the phraseology of the voice communication in the single flight phase. The code combination will be added to particular one-time commands to make possible their transfer and indication on board on conventional format of user message. The requisite bit range for the creating of the one-time commands file will be reserved.

### **PAR data transfer subsystem**

PAR data transfer subsystem is realized in the VHF band (frequency range 138–144 MHz). It consists of the ground and the airborne segment. The ground segment has got the PAR data integrator and the DGPS DC integrator on the

RS 232 interface. The RS 232 interface makes the PAR data input and the DGPS DC input into the transmission channel possible. For the transfer the PAR data file is preferred during the service of the demands. The PAR data are coming on the input in the according user binary format of the message. The constant length of the message is 96 bits. The following Cyclic Redundancy Code (CRC) ensures the reformatting of the message into the user format RTCA and the code providing of the CRC transfer. The transmitter modem will transfer the binary signal into the audiosignal with the application of the Mode 1 modulation, which modulates the communication VHF transmitter.

The airborne segment consists of the communication receiver, a modem and the CRC decoder.

The modem provides the convert of the audiosignal Mode 1 to the binary signal. The CRC decoder provides evaluation of error control coding and reformatting of PAR messages from RTCA format into original user format.

The channel output consists of the PAR data in the conventional user format for the Data Acquisition Unit and the separation of the DC of the DGPS for the GPS receiver. The separator is equipped with the RS 232 interface.

### **Data Acquisition Unit**

The Data Acquisition Unit (DAU) is determined to the concentrating and to the preliminary data processing from the individual sources of the multinavigation information. It reads the PAR data, the position of the DGPS, the deviations of the LOC and the GS, the distance of the DME and the altitude of the RALT and the Encoder data for the next processing. The data proceeds from the DAU into the Control Unit, they are stored in the defined files there. The DAU is the separated functional unit with its own microprocessor, which is monitoring every navigation sensors. The DAU processes the data of these sensors and it refers the data to the superior computer in the consistent form. It consists of the single units, the setting and the programmed properties of the units may differentiate by the use navigation. It is coincident interface for the connection with the superior computer, the unit of the D/A convertor, the discrete output and input unit, the Gray code decoder, the half-duplex serial interface for the communication with the GPS receiver, the PAR data receiver and the navigation system for all of the variant.

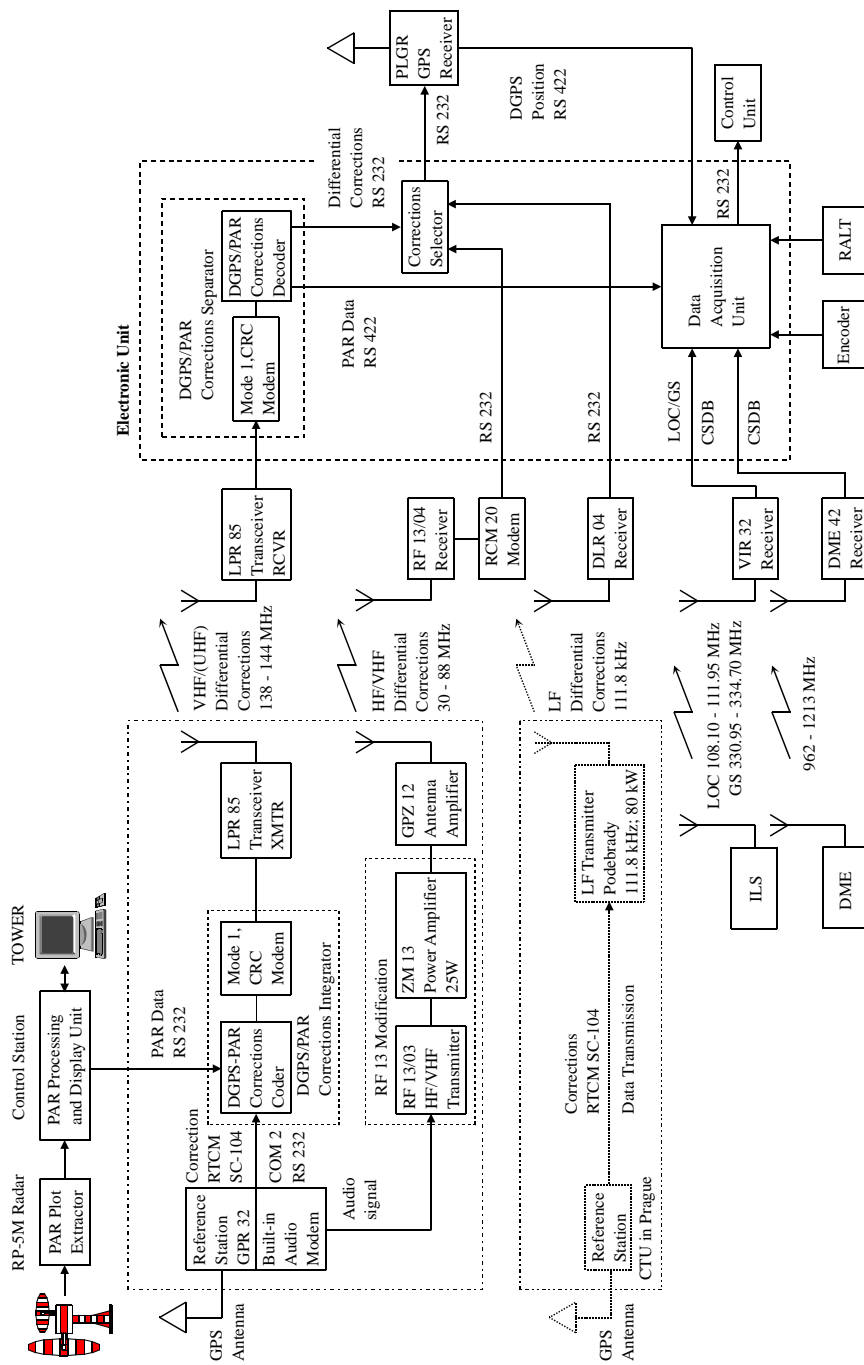

Fig. 1. Concept of Multinavigation Information MNI Processing and Display System



## The Control Unit

The Control Unit served for the Data Acquisition and for the control of the DC Unit during the flight tests. It stored the data from all sensors, they have been connected with the Control Unit by means of the half-duplex parallel interface in the EPP mode. Only data are transferred, the transfer of the addresses is not used. The main demand for the operation system of the Control Unit is its stability, the simple periphery service and for this phase of the project is important variety of the easy available means for the production of the software. The UNIX operation system and its freeware version LINUX for the trial project has been selected for these reasons. The UNIX operation system, should be also recommended for the final solution of the Approach system in the version for the work in the real time — QNX. The QNX operation system is applied in the aviation by now, among others it is used in the navigation system for helicopters. The using of the device programming language, which is assigned to the RT devices, will be the next possibility.

## ACHIEVED RESULTS

The aim of the flight test of the system was to ensure the storage of the ILS, PAR, DGPS data and the other auxiliary navigation informations during the Approach and the Landing. At the same time they made the appreciating of the interface function channel of the PAR data and the data preprocessing by the DAU. The stored data files then made their ensuring processing and evaluating of the accounting of the individual sources of the multination information possible. The aircraft position with regard to the approach segment in the Approach was simultaneously monitored by the Radio Telemetry Theodolite System (RTT). The control of the descent has been planned primary only in some of the specific points. It has been possible to receive and store the data files about the whole descent thanks to the possibility to fix the complete set of the RTT. The data files are supplied with the data in UTC time. The reference data file for the evaluating of the other archived files has been received by this way. The airborne radionavigation equipment of the applied aircraft made the IFR guidance for the Approach possible. This is why every descent manoeuvres were practised by the ILS. The utilization of the data navigation from the PAR files and the DGPS files for the guidance of the aircraft descent in the Approach was appreciated on the basis of the comparison of the evaluating deviations from the Final Approach Segment. The deviations from the final Approach segment are defined by the ILS System. The measured target positions from the separated sources of the navigation information has been received

in the different time moments, and with the different (for the individual systems constant) delay, it is why it was necessary to ensure their synchronization. It is mentioned the example of the comparison of the elevation and the azimuth deviations of the PAR system and the DGPS system from the Final Approach Segment in the dependence upon the distance from the touchdown on the Fig.2. The offset of the course of the deviations in the distance between the PAR system and the DGPS system is made by the different definition of the touchdown for the individual systems.

**Režim přistání pro dané zdroje navigační informace**

BOD DOTYKU : TDZ32: N 49° 56' 01,031" E 15° 23' 25,618" 286,95m Počet bodů: PAR 544 PLGR 105 TEO 301

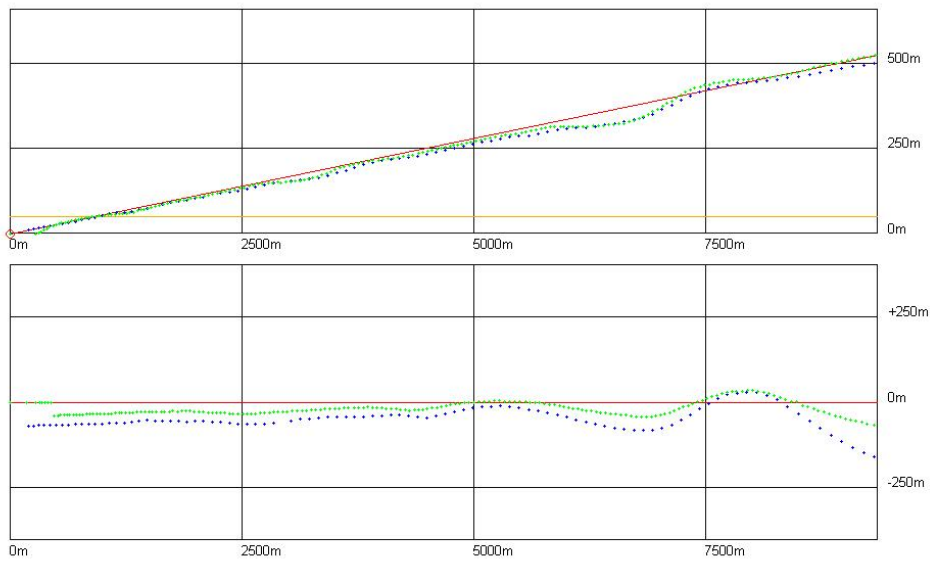

Fig. 2. The course of deviations of the PAR system and the DGPS system in the dependence upon the distance

## CONCLUSION

The results of the research task indicated the possibility to applicate the probing parts of the segment especially during the precise Approach. The results of the first phase of the research proved the possibility of the using of the DGPS system for the navigation in the En-Route and also in the Precise Approach. The results of the second part proved the possibility to use the PAR data for the precise Approach too.

We can see the possibility to arising the multinavigation system thanks to the using of the results of the first and the second phase. The MN system presents the comprehensive complex of the acquisition, the processing and the navigation informations. The comprehensive complex of the acquisition is used above all during the Precise Approach. It attends to the objective increasing of the safety of this flight phase because of the information above. This system should significantly increase the redundance of the navigation information and it could save the delete (filtration) of the navigation informations. Then it could improve the continuosness and improve the reability of the flight safety, especially in the critical phase of the Precise Approach. These improvements of the navigation parametrs of the navigation system should be displayed especially during the landing at the alternate airdrome. The aim of the next phase of the research of the MNI system is the working model of the construction Acquisition Data Unit, the processing and the display of the deviation of the aircraft from the descent trajectory, the distance to the touchdown and the terrain altitude in the phase of the precise Approach in the pilot's point of view. It is able to realize the indication by the help of the edict for the standard analogue indicators or by the way of the syntetic display on the multifunctional display.

The ILS and the DGPS systems provide the navigation in the real time and their common indication was verified experimentaly. The information of the PAR system shows the explicit time hysterezion, which manifests during synchronization by the distance and this is why its using needs the assigning of the aircraft position by means of the deviation its vector speed. This integration of the presented sources assumes first of all the providing of the standards for their selection, and then their processing by the method of the Kalmann's filtration for the optimal assigning of the aircraft deviations from the ordered FAS. The assigning of the distance to the touchdown and the altitude, which is resolving from the touchdown of the waiting increasing of the flight safet, demands an analogous way of the data processing as by the basic navigation informations. The informations about the distance to the touchdown and about the altitude are the complementary navigation informations.

#### REFERENCES

- [1] ANDRLE Milos, NAIDER Jiri, SUSEN Jaroslav, VOSECKY Slavomir, ZELINKA Jaroslav: Final report of research project ICAO/NAVIS/DGPS. Air Force and Defence Technical Institute Prague, 1999. (in Czech).
- [2] ANDRLE Milos, NAIDER Jiri, JERABEK Jaroslav, VOSECKY Slavomir, ZELINKA Jaroslav: Final report of research project NAVIS/2000, Volume 1. Air Force and Defence Technical Institute Prague, 2000. (in Czech).
- [3] Partial research reports of project NAVIS/2000. Air Force and Defence Technical Institute Prague, 2000. (in Czech).

## INTEGRATED FIX INFORMATION

### INTRODUCTION

The ECAC (European Civil Aviation Conference) states signed the basic document — the EUROCONTROL Airspace Strategy — describing the future evolution of the ECAC airspace organisation up to 2015 and then beyond. In the context of the Strategy, the airspace users community encompasses a wide range of quite different interest groups involved either in Commercial Air Transport Operations, Military Operations, General Aviation & Aerial Work Operations or Test Flights & Unmanned Aerial Vehicles Operations.

Current forecasts show a more than doubling of commercial air transport flights throughout Europe by 2015 based on 1995 traffic levels.

The future airspace organisation management processes have to address all of the expectations of these different user communities and therefore have to find trade-offs between the needs peculiar to each airspace user or Air Traffic Management (ATM) service provider category.

The strategic intent for the future ECAC airspace organisation is *“to progressively move towards an uniform airspace organisation leading to one continuum of airspace ... providing maximum freedom for all airspace users consistent with the required level of safety in the provision of ATM services, while making due allowance for the security and defence needs of individual States.”*

The desirable method of navigation within the European airspace is the Area Navigation (RNAV) – *„a method of navigation which permits aircraft operation on any desired flight path within the coverage of station-referenced navigation aids or within the limits of the capability of self-contained aids, or a combination of these (ICAO)“*.

Air traffic/air operation of different users within a limited airspace is possible only if the engaged navigation and surveillance systems fulfil all the main operational requirements – accuracy, availability, continuity and integrity. A final flight safety level is limited by measurement accuracy of immediate aircraft positions in space (“fixes”), by their repetition rate and also by reliability of those measurements.

Then any desirable growth of air traffic density is impossible apart from the previous corresponding increase of fix measurement accuracy in the given airspace segment.

Determination of true aircraft fixes within the given airspace depends upon several factors — the surveillance/fix measurement accuracy, the fix measurement repetition rate, surveillance systems working areas, the moments at which fixes of the same target are taken by different surveillance systems, the co-ordinate systems accepted e.t.c. Fortunately, the known differences in co-ordinate values as well as time and repetition rate effects can be processed and almost eliminated. What remain are the fix accuracy limitations, which depend upon operation possibilities of the navigation as well as surveillance systems engaged.

Air Traffic Control (ATC) ground surveillance/control systems still rely upon one kind of so called independent air traffic surveillance systems only. They are ground surveillance radars. Secondary Surveillance Radars (SSRs) represent fundamental sources of aircraft fix information for civilian air traffic services (ATS). Primary Surveillance Radars (PRs) serve as basic sources of fix information for military anti-aircraft defense systems (AAD) and for surveillance of the aircraft not equipped with SSR transponders.

Lacks of detection of some sorts of targets, a limited fix measurement accuracy as well as a relatively low fix repetition rate of the radars mentioned above call for parallel use of other kinds of surveillance systems which should cover the radar network “weak points” and help to improve a final accuracy and reliability of identification/surveillance/guidance of different aircraft/targets operating under RNAV flight conditions within the given airspace.

A complex of highly accurate and reliable ground reconnaissance/surveillance/control systems has been established and tested in recent years. The complex is highly effective and useful for exploitation especially at newly emerging common civilian/military ATS centres, named the Integrated Air Control Centres (IACCs), which are recently being planned and built throughout Europe. There are two kinds of alternative systems, which can serve as parallel no-radar means of ground surveillance. One of them is a system of independent surveillance — the Passive Surveillance System (PSS). The other is the Automatic Dependent Surveillance System (ADS).

## GEOMETRY OF THE SYSTEMS

### Radar Systems

Both SSR and PSR use the same method — the distance-angle method (see Fig. 1) — for measurement of aircraft fixes. Then the lines of constant values of aircraft azimuth  $\Theta$  always cross the circles of constant radar-aircraft horizontal distance (R) at the same angles  $\gamma=90^\circ$  and the system geometry is then hold as ideal.

There are two kinds of errors which determine the final radar error of the fix measurement. They are equal to

$$a = \Delta\Theta \cdot R \quad (1)$$

$$b = \Delta r \quad (2)$$

where  $2\Delta\Theta$  is the width of radar antenna beam and  $\Delta r$  is equal to the error of the radar distance-meter. Since  $\Delta r$  is relatively small and remains almost constant for all slant fix distances the final fix error depends above all upon the radar-aircraft horizontal distance and  $\Delta\Theta$  values.

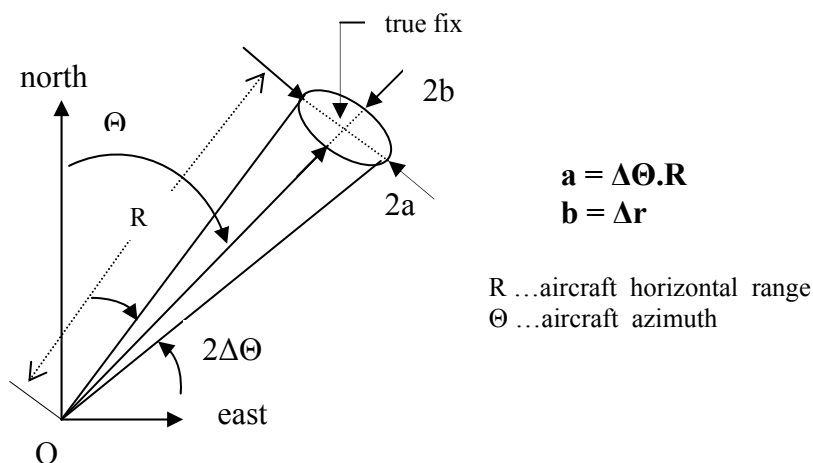

Fig. 1. Geometry of radars position lines ( $R, \Theta$ )

Beam widths of most of radar types tend to be  $1^\circ$  or more. For example at distances about 100 km this brings max. fix error value approx.  $a=1.7$  km and special complex and costly technical measures as monopulse or/and adaptive technologies must be employed to lessen it to the acceptable value. For example, if an aircraft position error be not allowed to exceed 500 m (see the EUROCONTROL standard of en-route flight path error), the maximum values of the accepted radar-aircraft distance have to be much smaller. This fact essentially influences multiradar processing in such a sense, that for the sake of avoiding too big errors of the final multiradar fixes (so called Joint Multi-Radar Information — JMRI) some appropriate weighting algorithms have to be implemented in the tertiary radar processor software which avoid negative influences of farther radar stations.

## Passive Surveillance Systems

Three or more stations of a PSS are located at different places. Geometry of this location depends upon the system role/use. A typical example of 3D PSS with its central master station **C**, three slave stations **1,2,3** and two position curves  $\Delta R_1$  and  $\Delta R_2$  are seen in Fig. 2. Corresponding distance difference values are equal to

$$\Delta R_i = R_{i,\alpha} - R_{i,\beta} = c \cdot \Delta t_i = 2a_i = 2 \cdot \sqrt{(e_i^2 + b_i^2)} \quad (3)$$

where  $\Delta t_i$  is the time difference between target signal arrivals at the **C** (master) station and at the given side station (TDOA — Time-Difference of Arrival value). Hyperbolic position curves cross each other at the fix. The final fix error depends both upon the errors of single hyperbola measurements (distance difference  $\Delta R_i$  values or simply on the time delays  $\Delta t_i$ ), and also upon the crossection angle  $\gamma$ .

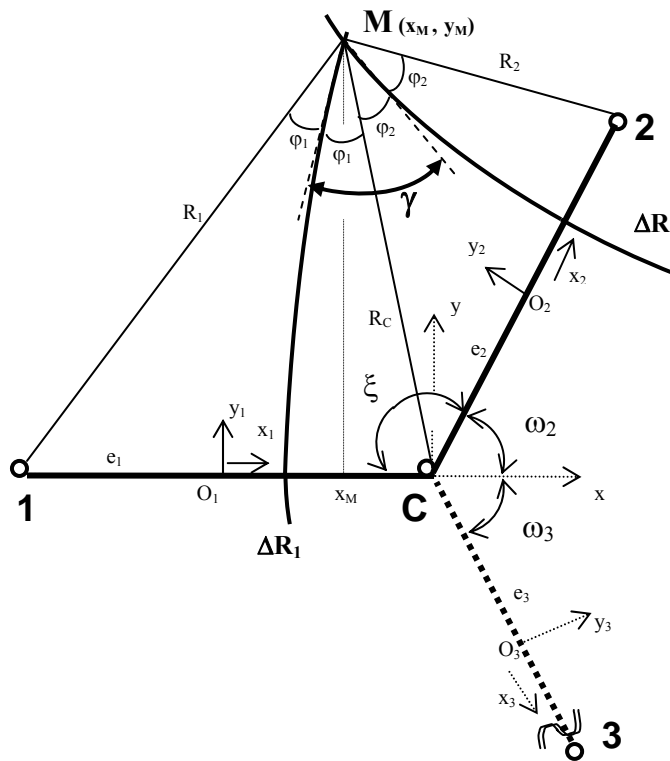

Fig. 2. Geometry of the PSS position lines ( $\Delta R_i, \gamma$ )

If

$$x_1 = x + e_1 \quad x_2 = x \cdot \cos \omega_2 + y \cdot \sin \omega_2 - e_2 \quad x_3 = \frac{x}{\cos \omega_3} - e_3$$

$$y_1 = y \quad y_2 = y \cdot \cos \omega_2 - x \cdot \sin \omega_2 \quad y_3 = x \cdot \sin \omega_3 + y \cdot \cos \omega_3$$

and

$$e_i = \sqrt{(a_i^2 + b_i^2)} \quad b_i = \sqrt{(e_i^2 - a_i^2)}$$

$$R_{i,\alpha} = [(x_i + e_i)^2 + y_i^2]^{0.5} \quad R_{i,\beta} = [(x_i - e_i)^2 + y_i^2]^{0.5}$$

then the hyperbolae and their tangents

$$\frac{x_i^2}{a_i^2} - \frac{y_i^2}{b_i^2} = 1 \quad (4)$$

$$y_i' = \pm \frac{b_i}{a_i} \frac{x_i}{\sqrt{(x_i^2 - a_i^2)}} \quad (5)$$

yield

$$\gamma_{1,2} = \left| \arctg y_1' - \left[ \arctg y_2' + \omega_2 \right] \right| \quad (6)$$

$$\gamma_{1,3} = \left| \arctg y_1' - \left[ \arctg y_3' + \omega_3 \right] \right| \quad (7)$$

$$\gamma_{2,3} = \left| \arctg y_2' - \left[ \arctg y_3' + (\pi - \omega_2 - \omega_3) \right] \right| \quad (8)$$

and

$$\varphi_i = \frac{1}{2} \cdot \arccos \frac{R_{i,\alpha}^2 + R_{i,\beta}^2 - (2 \cdot e_i)^2}{2 \cdot R_{i,\alpha} \cdot R_{i,\beta}} \quad (9)$$

$$\sigma_{\Delta\ell} = \frac{\sigma}{2 \cdot \sin \gamma} \cdot \sqrt{\left( \frac{1}{\sin^2 \varphi_1} + \frac{1}{\sin^2 \varphi_2} \right)} \quad (10)$$

where  $\sigma_{\Delta\ell}$  is a root-mean square value of the aircraft position (fix) error and  $\sigma$  is the root-mean square value of the distance - difference (c. $\Delta t_i$ ) error. Low cost, high sensitivity and accuracy, and a good experience with their long-time remote operation under bad weather conditions have allowed the PSS to play important roles in both en-route 3D or 4D air reconnaissance//air surveillance as well as in precise approach and airfield surface navigation.



## Automatic Dependent Surveillance

Position measurement errors of airborne GPS receivers operating on the Standard Positioning Service (SPS) are of values 30–100 m. Accuracy of the military Precise Positioning Service (PPS) receivers is higher. Differential GPS (DGPS) mode fix errors can drop down to submeter values. A standard GPS fix repetition rate is one fix per second. This gives a good chance for simple reconstruction of the aircraft flight trajectory at the ADS receiver output. Addressed ADS messages allow a reliable identification of any individual aircraft at ground ATS centres. There are two ways of getting ADS messages to ground ATS sites – one is via the SSR mode S format and the other is via a VHF Data Link (VDL). ADS signals can serve either as calibration information for the given SSR stations or as regular fix messages for ATC controllers.

### FIX INTEGRATION

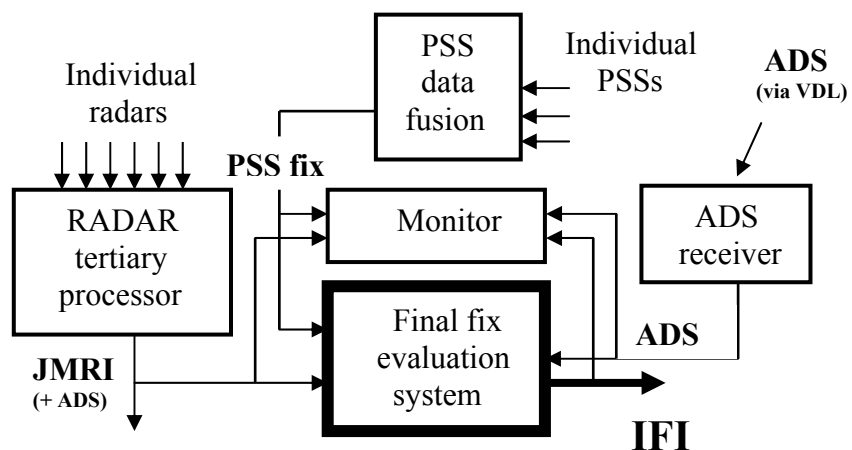

Fig. 3. Final fix integration/monitoring system

A large amount of fix data is being parallelly generated by simultaneously operating radar stations. The radar network affords a very useful reconnaissance, navigation, and surveillance/control information. A given radar network is also able to operate continuously for a long-time. In spite of these advantages the network final product (JMRI) does not contain all the information needed. Moreover — accuracy of JMRI fixes is dependent upon many factors (technical

quality of a radar station, its location with respect to the aircraft path measured, different fix repetition rates of individual radars, target identification limits of PSR as well as SSR e.t.c).

PSS network is a very potential source of reconnaissance, surveillance, and navigation informations. Narrow-band PSSs are intended for detection of airborne radar transponder signals. Broad-band PSSs are able to detect any electromagnetic signal. Passive operation, broad-band detection, high sensitivity, a very good ability of target identification (not only of different types but also of individual aircraft which had been detected before), high fix measurement accuracy, large operation areas, low cost and reliable remote operation/control of PSS slave stations successfully help „to fill the gaps“ of the JMRI and of radar operation. But a rather long fix repetition period of up-to-date PSS (similar to that of radars) still prevents timely and reliable detection of quickly changed positions and flight directions of highly manoeuvring aircraft.

ADS is intended to serve both as a time-and-fix calibration signal and as a regular source of aircraft fixes. Possible time gaps which may occur in ADS signal reception can be easily covered by radar and PSS networks.

## CONCLUDING REMARKS

1. Both the safety of civilian air traffic and the readiness of Air Force and Air Defence unit significantly depend upon levels of accuracy and reliability of the aircraft immediate position measurement.
2. Up-to-date aircraft position measuring ATC surveillance systems (radars) still do not offer all the information necessary to fulfil all tasks of newly intended Integrated Air Control Centres (IACC).
3. The PSS and the ADS have been recognized as very powerful aids which can strengthen ATS/ATC/Air Force/Air Defence capability.
4. Radar, PSS and ADS data fusion results in the IFI (Integrated Fix Information) suitable for good and prompt civil/military air co-operation.

## REFERENCES

- [1] EUROCONTROL Airspace Strategy for the ECAC States, January 2001.
- [2] The Integrated ATC Complex System of the Czech Republic and the Czech Army. (Komplexní integrovaný systém zabezpečení řízení letového provozu České republiky a Armády ČR), Prague, December 2001.
- [3] VOSECKÝ Slavomír: Integrated Navigation System (NAVIS – navigační integrovaný systém řízení letového provozu VČR a AČR, ideový projekt), Czech Republic, Brno, 1999.



## **RADAR TARGET DETECTION WITH REDUCED RADAR CROSS SECTION**

### **INTRODUCTION**

There has been growing interest over the last 30 years in the application of bistatic and multiposition radar techniques for both long and short range surveillance radar. Currently, low observable (LO) aircraft have been designed to have a low backscatter cross section. It can be shown that using aircraft shaping techniques to reduce the backscatter return of LO aircraft tends to increase the bistatic RCS of the same aircraft, thereby increasing its probability of detection. Bistatic radar systems may have important advantages with respect to monostatic radar systems. Besides having greater freedom in selecting waveform modulations, getting more information out of every transmitted signal and are less vulnerable to ECM and ARM-threat.

Very important and interesting is using commercial sources as transmitter for illumination for example TV a radio broadcasting net or mobile telephone net. Processing of backscattered signal from air objects illuminated by commercial sources may be realised by detecting, tracking and measuring the position of these objects.

### **RCS REDUCTION**

There are four basic techniques for reducing RCS [1]. They are:

- Shaping;
- Radar absorbing materials;
- Passive cancellations;
- Active cancellation.

The objective of shaping is to orient the target surfaces and edges so as to deflect the reflected energy in direction away from the radar. This cannot be done for all viewing angles within the entire sphere of solid angles because there will always be viewing angles at which surfaces are seen at normal incidence and there the echoes will be high. The success of shaping depends on the existence of angular sector over which low RCS is less important than over others.

Shaping can best be exploited if threat sector are established. This is because shaping usually does nothing more than shift the region of high echoes from one aspect angle sector to another. The RCS reduction achieved over one sector is

accompanied by an RCS enhancement over another. We might think that the surface of the target can be enclosed by a surface having a lower RCS. For example a square flat plate enclosed by a cylinder or sphere just large enough to accommodate the plate as depicted in Fig.1. The echoes from these three targets can be estimated and compared using these prescriptions

$$\sigma_{plate} = \frac{a^2}{\pi} \left[ k a \cos \theta \frac{\sin(k a \sin \theta)}{k a \sin \theta} \right]^2 \quad (1)$$

$$\sigma_{cylinder} = \frac{2\pi r l^2}{\lambda} \quad (2)$$

$$\sigma_{sphere} = \pi r^2 \quad (3)$$

where  $a$  is the dimension of the plate,  $l$  is the length of the cylinder,  $r$  is the radius of the cylinder or sphere.

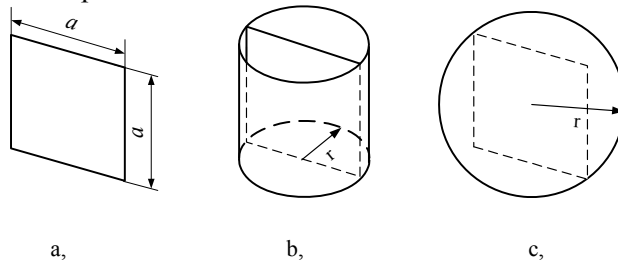

Fig. 1. RCS of (a) flat plate reduced by (b) cylinder or (c) sphere

The RCS patterns are plotted for an arbitrary plate length of  $25\lambda$  and have been normalized to the square of the plate length in Fig. 2. The flat plate has a large secular value for broadside incidence at  $\theta = 0$  and falls off very quickly as the aspect angle increasing.

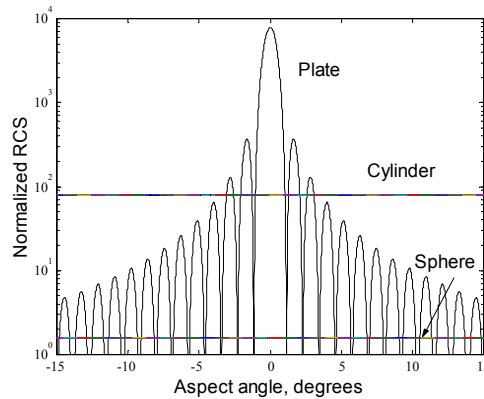

Fig. 2. RCS patterns of flat plate, cylinder and sphere

It is clear, that a substantial reduction in RCS is available if the plate can be oriented so that it is never seen broadside. The RCS of the cylinder is independent of  $\theta$  because it is rotationally symmetric about the axis normal to the direction of incidence and lies some 20 dB below the specular plate return. Similarly, the return from sphere is constant and lies nearly 30 dB below the specular plate echo. The display of Fig. 2 also illustrates that a reduction of RCS at one angle is usually accompanied by an enhancement at another.

Radar absorbing materials reduce the energy reflected back to the radar by means of absorption. Radar energy is absorbed through a kind of ohmic loss, dielectric loss or magnetic loss. Radar absorbers can reduce specular echo and creeping wave as well.

The basic concept of passive cancellation is to introduce an echo source whose amplitude and phase can be adjusted so as to cancel another echo source. This can be accomplished for relatively simple body. It is difficult to generate the required frequency dependence, and the reduction obtained for one frequency rapidly disappears as the frequency is changing. Moreover, the cancellation can revert to a reinforcement with a small change in frequency or viewing angle.

Active cancellation is the less discussed part of RCS reduction. In this case the target must emit radiation whose amplitude and phase cancels the reflected energy. Target must sense the angle of arrival, intensity, frequency and waveform of the incident wave. It must also know its own echo characteristics for that particular wave and angle of arrival. It must be fast enough to generate the proper waveform and frequency, and versatile enough to adjust and radiate a pulse of the proper amplitude and phase.

## BISTATIC RADAR

Bistatic radars are sometimes grouped into two general types: narrow angle bistatic systems wherein the transmitting and receiving antennas are not widely separated, and wide angle bistatic systems wherein the angle the transmitting and receiving antenna beams at the target approaches  $180^\circ$ . In general monostatic and bistatic RCS are not equal. For small bistatic angles the bistatic RCS is closely approximated by the monostatic RCS. For larger bistatic angles such a simple equivalence is no longer valid.

Range of bistatic radar system is defined by:

$$P_r = \frac{P_t G_t G_r \lambda^2 \sigma}{(4\pi)^3 R_t^2 R_r^2 L_t L_r L_p} \quad (4)$$

where  $P_r$  is the received power,  $P_t$  is the transmitted power,  $G_t$  the transmit antenna gain,  $G_r$  is the receive antenna gain,  $\lambda$  is the wavelength of transmitted signal,  $\sigma$  is the target bistatic cross-section,  $R_t$  is the transmitter to object range,  $R_r$  is the object to receiver range,  $L_t$  are the propagation losses transmitter to object,  $L_r$  are the propagation losses object to receiver,  $L_s$  are the losses in processing system.

The principle of bistatic radar system is given in Fig. 3 [2, 3]. Where  $\varphi$  is azimuth of transmitter antennas characteristic,  $\Theta$  is azimuth of receiver antennas characteristic,  $\beta$  is angle of observation base,  $v$  is velocity of target and  $\alpha$  is the course of observed object.

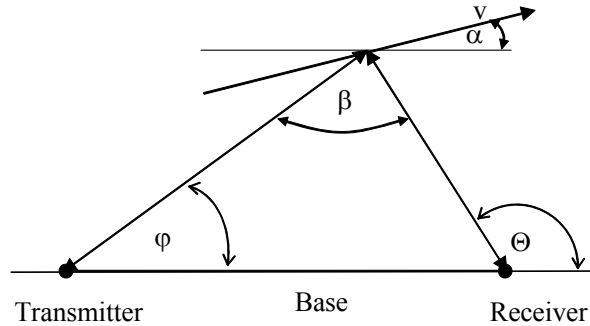

Fig. 3. Bistatic radar geometry

The co-ordinates of air object can be estimated by hyperbolic, elliptic, Doppler and bearing method. The co-ordinates can be evaluated by known relationships [1]. When bistatic radar system measure  $\theta$ ,  $\varphi$  parameters and  $R_t+R_r = S$ , then co-ordinates in rectangular system are defined by

$$x = \frac{S \left( \frac{2a}{S} - \cos \varphi \cos \theta \right)}{\left( \frac{2a}{S} \right) \cos \varphi \cos \theta - 1}; \quad y = \frac{S \left( \frac{4a^2}{S^2 - 1} \right) \cos \varphi \sin \theta}{\left( \frac{2a}{S} \right) \cos \varphi \cos \theta - 1}; \quad z = \frac{S \left( \frac{4a^2}{S^2 - 1} \right) \sin \varphi}{\left( \frac{2a}{S} \right) \cos \varphi \cos \theta - 1} \quad (5)$$

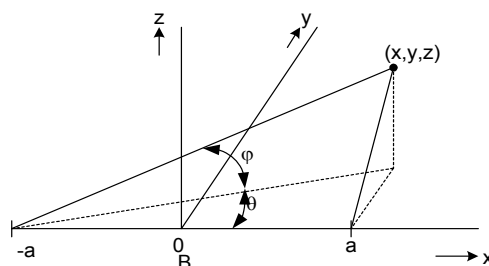

Fig. 4. The co-ordinate system

The measure of error of position an air object (Fig. 3) depends on base option B, ratio  $(R_t+R_r)/B$  and on precision of measured parameters  $\varphi$ ,  $\theta$  and  $S$ . When the co-ordinates are estimated according to Doppler frequency shift, then relationships are more complicated and require more receivers.

The monitoring by bistatic radar includes more manners **Hiba! A hivatkozási forrás nem található.**4]. In Fig. 5 are presented two, which are convenient for using of commercial transmitter illuminator for radar purpose.

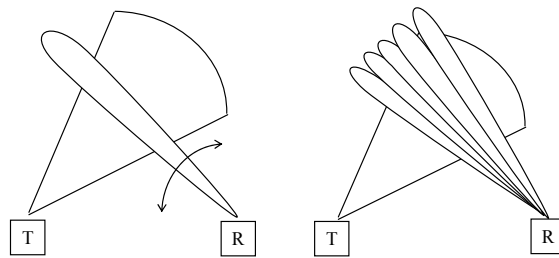

Fig. 5. Antennas characteristics of bistatic radar system

## MULTIPOSITION RADAR SYSTEM

Multiposition radar system (MRS) include co-operate transmitter and receiver stations with different structure. The Fig. 6 presents structures of MRS, which are appropriate for non traditional radar methods [7].

For target detection and location in multiposition radar systems some kind of system coordination and synchronization between the different sites are required. This includes spatial, time and phase synchronization and the frequency, waveform as well as transmitter and receiver position must be known. Critical point of design and operation of MRS is the spatial controlling of distributed stations, mutual synchronisation, date transition between stations and reference signals generation for time coherent signal processing in receivers.

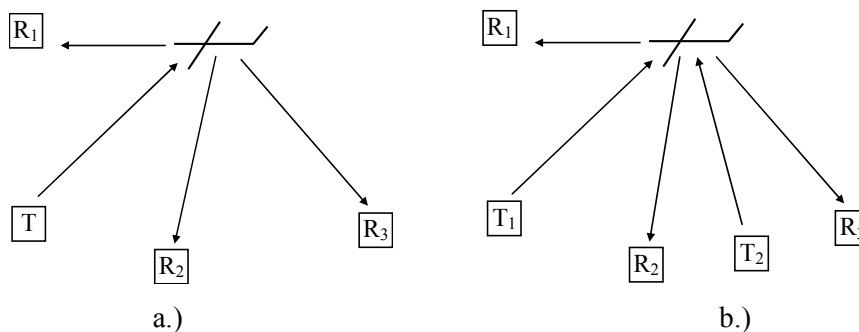

Fig. 6. MRS with (a) one transmitter and (b) two transmitters



For mutual synchronisation of MRS navigation system can be used; for example GPS or special communication channel. Reference signals can be formed in central unit and transmitted to remote station by communication channels. Coherent signal processing based on Doppler frequency shift requires delivering a pattern of transmitted signal to receiver station. High effectiveness of synchronization and time coherent processing of received signals can be achieved by directly receiving of transmitted signals in main lobe eventually in side lobes. The spatial position of object with desired accuracy is determined by evaluating of phase of received signals. One receiver and several transmitters with known positions or by one transmitter and some receivers may accomplish this. Specific problem is design of special receivers for radio or TV signals. For radar purpose is very interesting using of transmitters mobile telephone net. Some problems are solved in **Hiba! A hivatkozási forrás nem található.** [5, 6].

## CONCLUSION

The inherent advantage of bistatic radar can have a direct impact the future development of radar systems. Using shaping techniques to reduce the backscatter return of LO aircraft tends to increase the bistatic RCS, thereby the bistatic radar become more popular. Development of communication systems, positioning systems, signal and data processing can allow create available bistatic radar system to detect targets even with reduced RCS.

Moreover, the multiposition radar system based on using commercial transmitter net seems to be a very useful source of radar information for short range use. This system can provide increasing amount of radar information in spatial monitoring with required accuracy. MRS using signals of commercial transmitters can detect and track air objects in complicated electromagnetic background.

## REFERENCES

- [1] KNOTT, E. F.-SHAEFFER, J. F.-TULEY, M. T.: Radar Cross Section. Artech House, Inc. Dedham, 1985.
- [2] SKOENIK, M.: *Spravočník po radiolokaciji*. Moskva, Sov. radio 1978, s. 193-216.
- [3] DUNSMORE, M.: Bistatic radars. In: *Advanced Radar Techniques and Systems*, Peter Peregrinus Ltd., 1993, s. 822-920.
- [4] RETZER, G.: A concept for signal processing in bistatic radar. In: *IEEE International radar conference* Arlington, April 28 – 30, 1980, pp. 288-293.
- [5] GRIFFITHS, H. – LONG, N.: Television-based bistatic radar. In: *IEE Proceedings*, 1986, p. 649-657.
- [6] LANTERMAN, A. D.: *Tracking and recognition of airborne targets via commercial television and FM radio signals*. In: [www.ifp.uiuc.edu/~lanterma](http://www.ifp.uiuc.edu/~lanterma), 2001.
- [7] TKÁČ, J. et al.: *Multisensor radar data processing*. The research report. Liptovský Mikuláš, 1996. (in Slovak)

## **FUZZY LOGIC-BASED MAINTENANCE DECISION**

The real world has some uncertainty and people do not always use precise definitions. The very great experience of engineers and technicians is similar to the real world's feature mentioned above. The fuzzy logic based methods can be used to make maintenance management-decision. This paper shows an example to determine time between state-estimation and permissible parameter values.

### **INTRODUCTION**

As humans, we often rely on imprecise expressions like “usually”, “expensive” or “far”. Therefore, the real world has some uncertainty and people do not use always-precise definitions. In the engineering these ones can be error in measurement, inaccuracy results from digitalization or the integrated system's parameter-uncertainties.

The fuzzy logic is a relatively new mathematical tool, which can be used to model the inaccuracies and uncertainties of the real world mentioned above. LOFTI ZADEH, at the BERKELEY UNIVERSITY, issued first publications in the middle of 60's about the fuzzy logic. He was the first researcher who successfully applied non-binary logic in his work and called this part of the mathematics as “fuzzy”. Within conventional logic, terms can be only “true” or “false”. Fuzzy logic allows a generalization of conventional logic. It provides for terms between “true” and “false” like “almost true” or “partially false” [1].

In the aircraft engineering and in the technical management, the fuzzy logic is – can be or should be – used as a fuzzy control, decision making and diagnostic expert systems.

The very great experience of engineers and technicians is similar to the real world's characteristics mentioned above. This experience can be analyzed and utilized statistically applying the fuzzy logic. The fuzzy logic based methods can be used during trouble-shooting and to make management-decision. Using the fuzzy logic, the experts can model and solve the complicated and antinomic tasks.

The author met similar problem his earlier scientific work, when he developed a mathematical model-based maintenance management method [7]. The regulations and technical specifications do not have date about the permissible parameter values of pneumatic break system of helicopter Mi-8. Therefore the experts (pilots and

mechanical engineers) were reported. The Table 1. shows statistical results of survey. The valuable answerers were 35% of the expert population.

Statistical Results of Expert Reports Table 1.

Permissible values		Engineers	Pilots
Break-effort [%]	Minimum	0,0	0,0
	Maximum	50,0	50,0
	Medium	20,5	17,8
	Median	20,0	17,5
Break asymmetry [%]	Minimum	0,0	0,0
	Maximum	35,0	25,0
	Medium	10,1	7,4
	Median	5,0	5,0
Correlation between parameters		0,475	0,164
Times between state-estimations			
Flying hours [hour]	Minimum	5,0	
	Maximum	200,0	
	Medium	79,8	
	Median	100,0	
Calendar time [day]	Minimum	3,0	
	Maximum	365	
	Medium	120,7	
	Median	60	

## DETERMINATION OF PERMISSIBLE PARAMETERS

To determine the permissible parameters on depend of expert reports the logical expression of decision should be taken down:

**IF** break-effort  
**OR** break asymmetry meets the critical value  
**THEN** the system should be maintained. (1)

The membership functions of necessity of break-effort and break asymmetry determined by Table 1. are shown by Fig 1.

It is interesting to mention that pilots suggested lesser permissible parameters than

engineers did. Because of they experience consequence of failure directly. But engineers have stronger correlation between break-effort and asymmetry. These can be expounded that engineers have more consequent technical knowledge. The main task and aim of fuzzy logic is to model and solve mathematically these different opinions. Analog fuzzy one of logical operation **OR** is the **MAXIMUM**, so the logical expression (1) meets the given value if one of assumptions meets it. Therefore the determination of permissible values is to determine parameter values, in case of which their truth-values meet the given value.

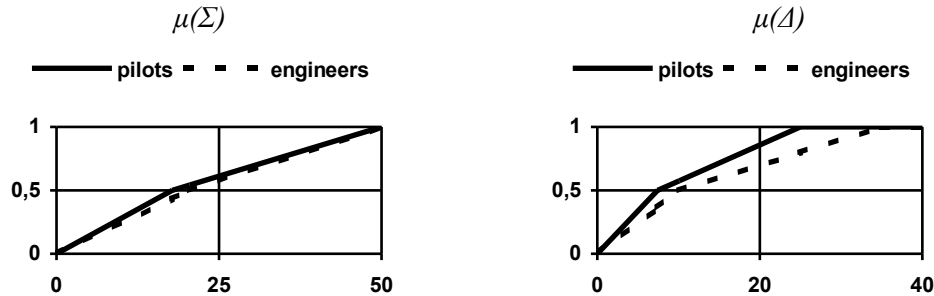

Fig. 1. Membership Functions of Permissible Values

It is expedient that the permissible truth-value of logical expression (1) is 0,7 ~ 0,8. It means that the truth-value of inadmissibility of maintenance of break-system is 0,3 ~ 0,2.

Permissible Values Determined by Fuzzy logic Table 2.

	$\delta F_{\Sigma h} [\%]$		$\delta F_{\Delta h} [\%]$	
	$\mu(\Sigma) = 0,7$	$\mu(\Sigma) = 0,8$	$\mu(\Delta) = 0,7$	$\mu(\Delta) = 0,8$
Pilots	30,68	37,10	14,44	17,96
Engineers	32,30	38,20	20,06	25,04

The Table 2. shows permissible values of parameters incident to the truth-values mentioned above.

## DETERMINATION OF TIME BETWEEN STATE-ESTIMATIONS

Because of the developed diagnostic method should be adapted to an existing maintenance system, the state-estimation can be applied in earlier-determined period.

To determine time between state-estimations firstly the logical expression of decision should be taken down:

$$\begin{array}{ll}
 \text{IF} & \text{checking is need taking into calendar time} \\
 \text{OR} & \text{taking into flying hours} \\
 \text{THEN} & \text{state-estimation is need.}
 \end{array} \quad (2)$$

The membership functions of necessity depend on calendar and flying time determined by Table 1. can be seen in Fig. 2. These functions have been determined by results of the expert reports mentioned above.

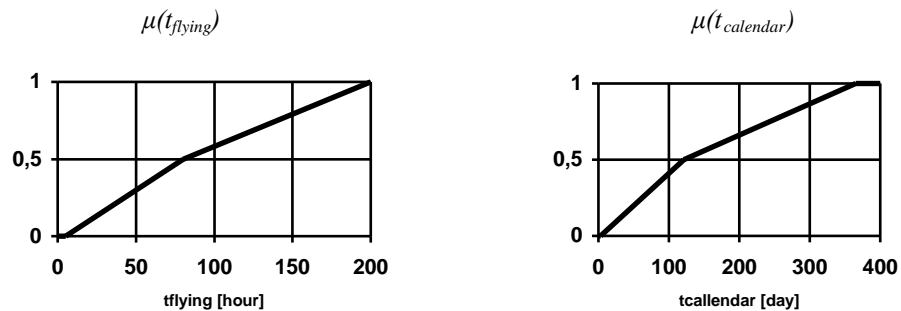

Fig. 2. Membership Function of Times

The task is to determine truth-values of expression (2) in case of practicable (used) calendar and flying time periods (see Table 3.).

by Flying Time	$t_{flying}$ [hour]	$\mu(t_{flying})$	by Calendar Time	$t_{calendar}$ [nap]	$\mu(t_{calendar})$
$50^{+10-5}$ hour	60	0,367	After $60^{+5}$ days	65	0,263
	45	0,267		60	0,242
$100^{+20-10}$ hour	120	0,667	During provisions	240	0,745
	90	0,542		120	0,496
$200^{+40-20}$ hour	240	1			
	180	0,917			

The recommended truth-value of logical expression (2), that is necessity of system controlling is 0,7 ~ 0,8. This means that needless of state-estimation is 0,2 ~ 0,3.

Therefore, the suggested times between state-estimation of pneumatic break system of helicopter Mi-8 *Hip* are:

$$100^{+20-10} \text{ flying hours}$$

and

during summer and winter provisions.

It is important to mention that these results are less weighty than ones determined by other (statistical) methods. The time intervals are longer and permissible parameter values were augmented too. The author thinks that the results of fuzzy investigation mentioned above are fitter than other ones. But he cannot explain his opinion exactly, “only” on the basis of his experiences got during longtime practical and mathematical modeling work.

## CLOSING REMARKS

This paper showed the possibilities of use of fuzzy logic during maintenance decision making. This methods was shown by simplified determination of permissible parameter values and inter-state-estimation times of pneumatic break system of helicopter Mi-8 *Hip*.

## REFERENCES

- [1] BORGULYA, I.: Neurális hálók és fuzzy-rendszerek, Dialóg Campus, Budapest–Pécs, 1998, pp226.
- [2] BOWLES, J. B., PELÁEZ, C. E., Fuzzy Logic Prioritization of Faliures in a System Failure Mode, Effect and Criticality Analysis, Reliability Engineering and System Safety 50 (1995) p. 203-213.
- [3] DANILOV, V.A.: Vertolet Mi-8, Transport, Moscow, 1988.
- [4] GIRARDELLI, E., DIDÓ, F.: Diagnostic from System Models: The Adam System Approach, Proceedings of the 21<sup>st</sup> ICAS Congress, Melbourne, 1998 (CD version).
- [5] POKORÁDI L.: Fuzzy Logic — The Mathematical Base of Robot Technique, Robot Warfare, Porceedings of Conference on Robot Warfare, Budapest, 2001, p. 83-92.,
- [6] <http://www.zmne.hu/tanszekek/ehc/konferencia/april2001/pokoradi.html>.
- [7] POKORÁDI L.: Fuzzy Technique in the Aircraft Engineering, Proceedings of VSDIA 2000, Budapest (under publishing).
- [8] POKORÁDI, L., SZABOLCSI, R.: Aircraft Operation Management Based on State-Estimation, Proceedings of 21<sup>st</sup> ICAS Congress, 13-18 September 1998, Melbourne, Victoria, Australia (CD-version).
- [9] ROHÁCS, J., POKORÁDI, L., ÓVÁRI, GY., KAVAS, L.: Anomalies in Integrated Aircraft Systems, Proceedings of the AIMS 2000, Garmish-Partenkirchen, 2000, p. 269-281.
- [10] XIZHAO W., BIN CH., GUOLIANG Q., FENG Y.: On the Optimization of Fuzzy Decision Trees, Fuzzy Sets and Systems 112 (2000), p. 117-125.

## ACKNOWLEDGEMENT

This work has been supported by Széchenyi Professorship through grant No SzPÖ 0042/99, which is gratefully acknowledged.

## RECREATION AND EVALUATION OF THE AGING AIRCRAFT STRUCTURE FOR THE NEED OF LIFE-TIME EXTENSION

### INTRODUCTION

In this paper a method of generation a virtual model (3D-model) of an aircraft, basing only on the real aircraft structure (without the sufficient technical documentation), is shown. The first step is a precise co-axial measurement of the real aircraft structure. On this base, the models of the aircraft: Su-22 and MiG-29 were created using the UNIGRAPHICS CAD/CAM/CAE system [1, 4]. Then, the models mentioned above were utilised to design special models for the wind tunnel investigations and numerical calculations. In this way the sets of aerodynamic, and strength characteristics as well as free vibrations were obtained. In order to determine the co-ordinates  $x$ ,  $y$ ,  $z$  of the real object the following procedure was implemented:

- The aircraft was set on the jack-lift elevators according to the flight line (Fig.1), then the local grid should be set (Fig.2);
- All the linear and radial quantities were measured;
- The levelling of all the measured points was done;



Fig.1. Aircraft Su-22 set up to determine the co-ordinates  $x$ ,  $y$ ,  $z$

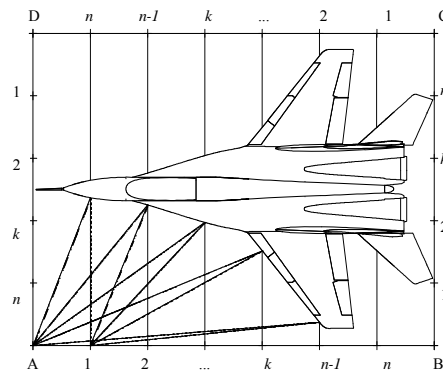

Fig.2. Local grid for high precision measurements of the co-ordinates  $x$ ,  $y$ ,  $z$



The measurement procedure:

- The instrument was set consecutively at all the points of the local grid, and the angles and distances were measured (Fig.2);
- The “heights” of the considered points were determined using precise levelling method.

The set of aircraft co-ordinates:  $x$ ,  $y$ ,  $z$ , was calculated on the base of the above determined quantities.

## NUMERICAL RECREATION OF AIRFRAME

Quality of the geometry recreation of the existing objects depends on: a method of the precise co-axial measurement, quality of the measuring instruments as well as CAD system used for a virtual aircraft creation aircraft.

The number of measurements, even 1000 points and more at a surface in various cross-sections of aircraft (see Fig.3) doesn't have any impact on the recreation quality. What is more, it can be a reason of the “rippling” phenomenon of the curves, during the creation of the virtual aircraft, what it means that the measurements were done with unsatisfactory precision. In this case, the process of surface smoothening must be implemented. Technical aircraft documentation (drawings, sketches, etc.) if such exists, is a considerable convenience during recreation, mainly for verification. The wing geometry was created on the base of measurement of thirteen wing cross sections [1].



Fig.3. Grid points after determining of the co-ordinates  $x$ ,  $y$ ,  $z$ :, Su-22 aircraft

Such a process of recreation of the aircraft structure is very complex and time consuming. In the case of the large structures we have to comply with the natural aircraft composition: wing, fuselage, tail unit, undercarriage. Following the procedure, component modules must be put together into complete unit, which is defined at the very beginning of the work (Fig.4).

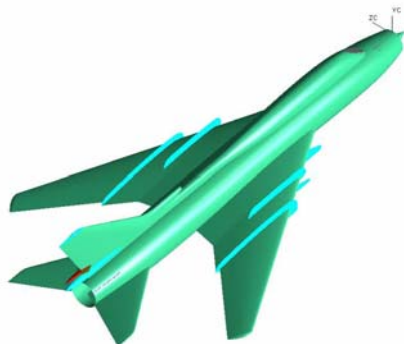

Fig.4. Virtual model of the Su-22 aircraft

To obtain a numerical model of the aircraft with a much complex aerodynamic layout, e.g. the MiG-29 aircraft (Fig.5) additional data are required; concerning the curves representing the geometry of aircraft components, such as: a strake-wing, etc. In this case the process of model generation must be preceded by selection of the aircraft elements, for which the additional precise measurements must be done.

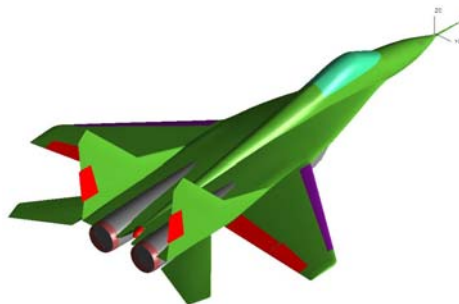

Fig.5. Virtual model of the MiG-29 aircraft

## INVESTIGATIONS AND NUMERICAL CALCULATIONS OF THE SU-22 AERODYNAMIC CHARACTERISTIC

Using a CAD/CAM system a model of the Su-22 aircraft (variable geometry wing aircraft) was designed and built. The wind tunnel investigations were carried out for the model of the clean configuration aircraft without the aerodynamic fences on the wing and the armament pylons as well as for the aircraft with high lift devices and various deflections of the stabiliser. The

investigations were conducted in a small velocity wind tunnel ( $D = 1.1$  m diameter of the measuring chamber).



Fig.6. Aircraft model with the sweep angle  $\chi_{sk} = 30^\circ$  in the wind tunnel

Wing tunnel investigations as well as calculations were made for two models with the sweep angles:  $\chi_{sk} = 30^\circ$  and  $\chi_{sk} = 63^\circ$ , respectively. For the clean configuration (without external pylons) and with high-lift devices in the neutral position and retracted undercarriage investigation were carried out in scope of the angles of attack from  $\alpha = -60^\circ$  to  $\alpha = 60^\circ$  with the step  $2,5^\circ$ . In addition, the influence of the horizontal stabiliser, (in scope of its angles of deflection from  $\delta_H = -26,5^\circ$  to  $\delta_H = 10^\circ$ ), flaps and ailerons on aerodynamic characteristics was investigated. Moreover, the models with ailerons and stabiliser in the neutral position referring to the real aircraft ( $\delta_i = 6^\circ$ ,  $\delta_H = -5^\circ$ ), for the range  $\alpha = -10^\circ$  to  $50^\circ$  and the step  $2,5^\circ$ , were investigated.

## AIRCRAFT EXTERNAL LOAD EVALUATION

This work must be started with determination of the aircraft service conditions. Due to the lack of the aircraft design requirements in the former Soviet Union for recreation of the external load acting upon the Su-22 aircraft, the American regulations for equivalent class of aircraft were employed.

According to [5], the velocities, which were taken for the determination of the external load acting upon an aircraft, should be related to the ultimate loads. The full spectrum of the aircraft loads required analysis of all the possible aircraft configurations, so it was time-consuming task. It was impossible to recreate all the data, but after the evaluation of the flight restriction imposed by Russian designers, it was possible to determine a critical point for  $Ma = 0.9$  and  $\chi = 63^\circ$  the sweep angle of the wing, and permissible load factor  $n = 7$ ,  $m = 14000$  kg.

A manoeuvring load factor was reduced for the other aircraft configurations. So, in this case as the essential point of the curve, the following point was selected:  $Ma = 0.9$ ,  $\chi = 63^\circ$ ,  $n = 7.0$ , and calculations of the pressure distribution on the wing were performed with the method of the vortex grid [2, 3,].

The load growth is a result of: the backward travel of the aerodynamic centre and a considerable increase in the pitching moment. So for balance of the aircraft there is a purpose for a huge amount of the force on the horizontal stabiliser acting downward [5].

In this case an increase of the lift force on the wing must appear. Basing on the available data it can be concluded that the maximal value of the pitching moment factor (without the stabiliser and  $\chi = 63^\circ$ ,  $x_{cg} = 38\%$  MAC) should not exceed  $C_{mbu} = -0.13$  ( $C_{mbu} = -0.188$  from calculations).

## STRESS ANALYSIS

The elements and nodes (FEM) for the Su-22 numerical model (see Fig.7). For the purposes of the stress analysis in the Su-22 structure the following numerical models were produced:

- Computational models of the main aircraft components for the preliminary evaluation of the aircraft as a whole;
- Verified models for more advanced research.

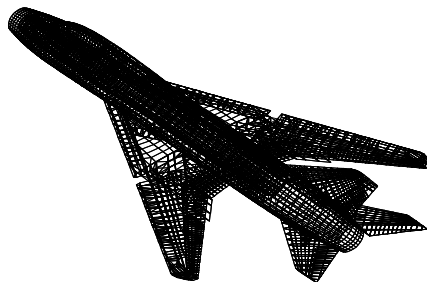

Fig.7 Model for calculations of the Su-22 aircraft

To minimise the computational time the UNIGRAPHICS processor was selected for the Finite Element Method (FEM) package NASTRAN. The grid of the nodes of the surfaces of the main aircraft components was set at points of the intersections of the theoretical lines of stringers, ribs, bulkheads and spars. The airframe skin was formed of the membrane and plate elements, frame bulkheads of beam elements, whereas the stringers of bar elements. The computations were conducted for the following flight parameters:  $m=14000\text{kg}$ ,  $\chi = 63^\circ$ ,  $Ma = 0.9$ ,

$n = 7$  and presented in Figs. 8 to 11. Fig.10 and 11 present the results for the wing spar. The maximum displacement 0.75 mm appears at the end of the wing spar, whereas the higher stress level is  $472 \text{ N/mm}^2$  around the lower attach lug (see Fig.11).

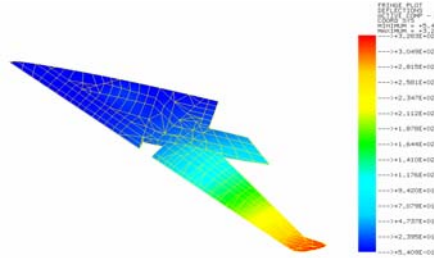

Fig.8. Wing displacements of the Su-22 aircraft

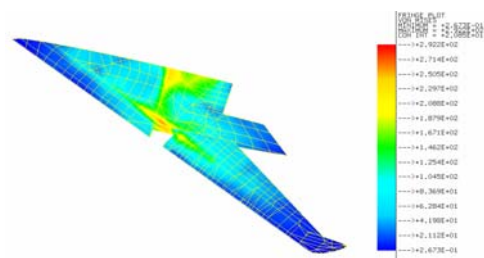

Fig.9. Von Mises stresses of the wing skin for Su-22 aircraft

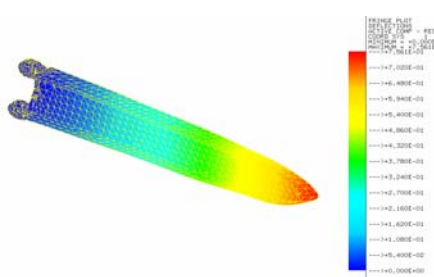

Fig.10. Wing spar displacements of the Su-22 aircraft

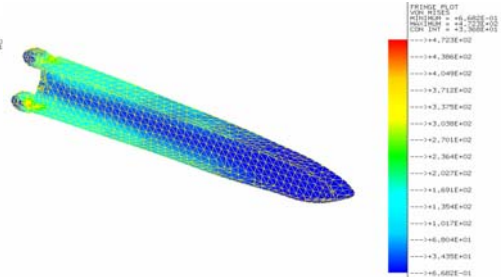

Fig.11. Von Mises stresses of the outer area of wing spar for Su-22 aircraft

## 6. ANALYSIS OF FREE VIBRATION

The analysis of the frequencies and modes was conducted for the Su-22 model (see Fig.7) with 65000 degrees of freedom, similar to the static evaluations. Fig.12 and 14 show the first modes of the free vibrations. Furthermore, the influence of the structure damage was detected.

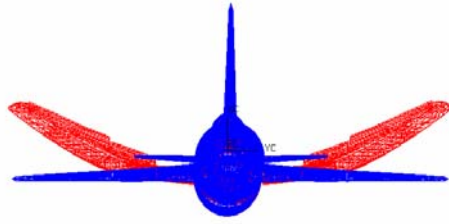

Fig.12. First symmetrical mode of the self-vibrations Su-22 aircraft,  
 $\omega_1 = 8,517$  Hz

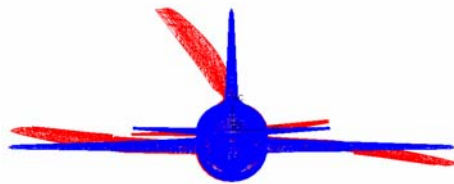

Fig.13. Second antisymmetrical mode of the self-vibrations Su-22 aircraft,  
 $\omega_2 = 11,04$  Hz

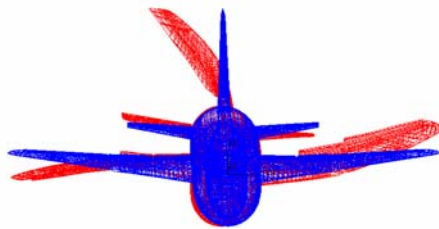

Fig.14. Third antisymmetrical mode of the self-vibrations Su-22 aircraft,  
 $\omega_3 = 12,79$  Hz

## CONCLUDING REMARKS

Using the CAD/CAE systems the algorithm of the numerical recreation of the existing objects was presented. In this case the UNIGRAPHICS system and its processor for the FEM NASTRAN was selected.

Methodology was presented for the assessment and evaluation of the technical state of the ageing fleet of the rotary and fixed wing aircraft in service of the PAF. As a sample the Su-22 was selected. The process of the recreation was difficult due to the lack of comprehensive technical and overhaul documentation as well.

## REFERENCES

- [1] Electronic Data Systems, UNIGRAPHICS - Modeling, Finite Element Modeling and Analysis. Maryland USA.
- [2] Lan E.C., A Quasi-Vortex-Lattice Method in Thin Wing Theory. Journal of Aircraft IX 1974.
- [3] Lan E.C., and Campbell J.F., Theoretical Aerodynamics of Upper-Surface-Blowing Jet-Wing Interaction. NASA TN D-7936 XI 1975.
- [4] Linsenbarth A., Special and ground photogrammetry. PPWK Warszawa-Wrocław 1974
- [5] Luis R., Miranda R.E.D., and William M., A Generalized Vortex Lattice Method for Subsonic and Supersonic Flow Applications. NASA Contractor Report 2865.
- [6] Olejnik A., Kachel S., Leszczyński P., Jarzębiński L., A study of the Su-22 structure for strength analysis, aerodynamics investigations, flight mechanics and free vibrations., Proceedings of the Fourth International Seminar on RRDPAE 2000.

## WHY I LIKE THE $(ax^2 + b)/x$ FUNCTION?

### INTRODUCTION

The  $(ax^2 + b)/x$  function is a very important function for production and operations managers and for reliability and maintenance experts, in other words: technical managers. They usually use this function to find the optimum solution to technical problems.

I would like to show some application of  $(ax^2 + b)/x$  function.

### BASIC ECONOMIC ORDER QUANTITY (EOQ) MODEL

The EOQ model is used to identify the order size that will minimize the annual cost of ordering inventory and the sum of the annual cost of holding inventory. The unit purchase price is not generally included in the total cost. So the total cost (TC) is equal annual carrying cost (CC) plus the annual ordering cost (OC).

$$TC = CC + OC \quad (1)$$

The total cost curve is illustrated in figure 1. The carrying cost is linearly related to order size, and the ordering cost is inversely and nonlinearly related to order size.

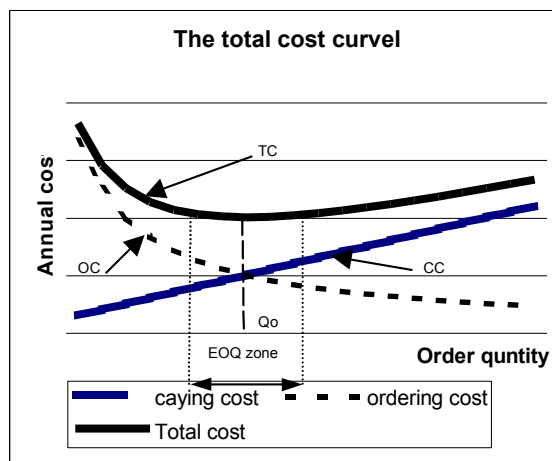

Fig. 1. The total cost curve



The total cost curve is U-shaped and that it reaches its minimum at the quantity where carrying and ordering cost are equal. An expression for the optimal order quantity ( $Q_0$ ) can be obtained using a simple calculus:

$$Q_o = \sqrt{\frac{2DS}{H}} \quad (2)$$

where :

- D — demand (units per year)
- Q — order quantity (in units)
- S — Ordering cost ( Ft)
- H — Carrying cost ( $\frac{Ft \times year}{unit}$ )

### Quantity discounts

Are price reductions for large orders offered to customers to induce them to buy in large quantities. The buyer's goal in the case of quantity discounts is to select the order quantity that will minimize total cost. So the new total cost is the sum of carrying, purchasing and ordering cost. (The total costcurve is illustrated in figure 1.) Recall that in the EOQ model, determination of order size does not involve the purchasing cost.

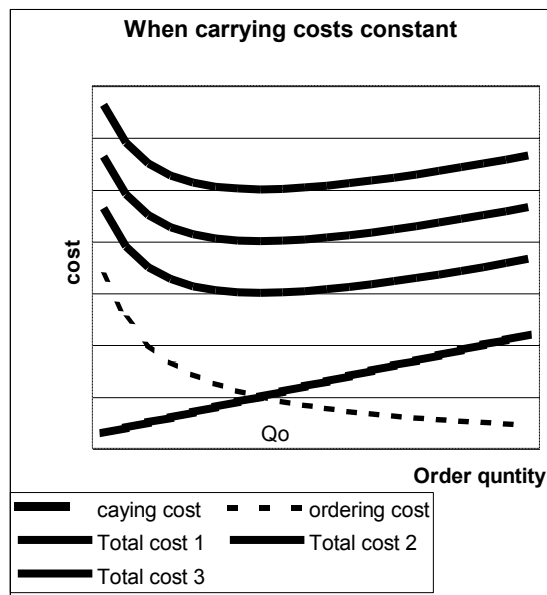

Fig. 2. When carrying costs are constants

A graph of the purchasing costs versus quantity would be a horizontal line. Hence, including purchasing costs would merely raise the total cost curve by the same amount at every point. That would not change the EOQ. So there are two general cases of the model:

- Carrying costs are constant and in the other carrying costs are stated as a percentage of purchase price. When carrying costs are constants, there will be a single EOQ that is the same for all of the cost curves. (figure 2.)
- When carrying costs are specified as a percentage of unit price, each curve will have a different EOQ. Since carrying costs are a percentage of price, lower prices will mean lower carrying costs and larger EOQs. (figure 3.)
- When carrying costs are specified as a percentage of unit price, each curve will have a different EOQ. Since carrying costs are a percentage.

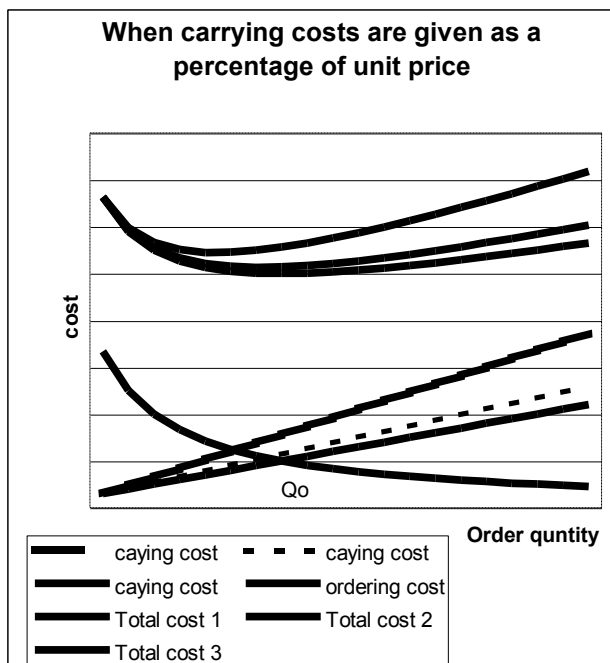

Fig. 3. When carrying costs are given as a percentage of unit price

## MAINTENANCE

The goal of maintenance is to keep production systems in good working order at minimal cost. Decision makers have two basic options with respect to maintenance. One option is reactive and the other option is proactive.

Breakdown maintenance (reactive) is to deal with breakdowns or other problems when they occur. Preventive maintenance (reactive) is to reduce breakdowns through a program of lubrication, adjustment, cleaning, inspection, and replacement of worn parts. Decision makers try to make a trade-off between these two basic options that will result in minimizing their combined cost. Without preventive maintenance repair cost would be tremendous. Furthermore, hidden costs such as the cost of wages while equipment is not in service, and lost production, must be factored in. Also the cost of injuries or damage to other equipment or facilities, or to other units in production. However, beyond a certain point, preventive maintenance is wasteful. The best approach is to seek a balance between preventive and breakdown maintenance. The concept applies to maintaining production systems: Strike a balance between prevention cost and breakdowns cost. This concept is illustrated in figure 4.

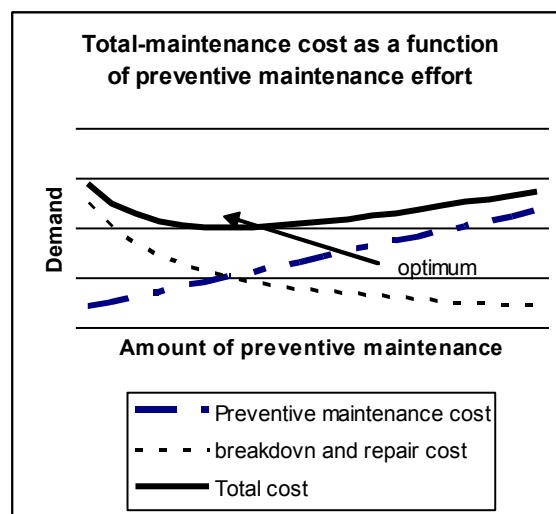

Fig. 4. Total-maintenance cost as a function of preventive maintenance effort

## INSPECTION

To determine if a process is functioning as intended, or the final products does not contain more than a specified percentage of defectives. The main question is: How much to inspect and how often? The amount of inspection can range from no inspection whatsoever to inspecting each item numerous times. The majority of quality control application lies somewhere between the two extremes:

- Most require some inspection –this is not always can be expensive.

— The cost of letting undetected defectives slip through is high enough that inspection cannot be completely ignored.

The amount of inspection needed is governed by the costs of inspection and the expected costs of passing, defective items. (figure 5).

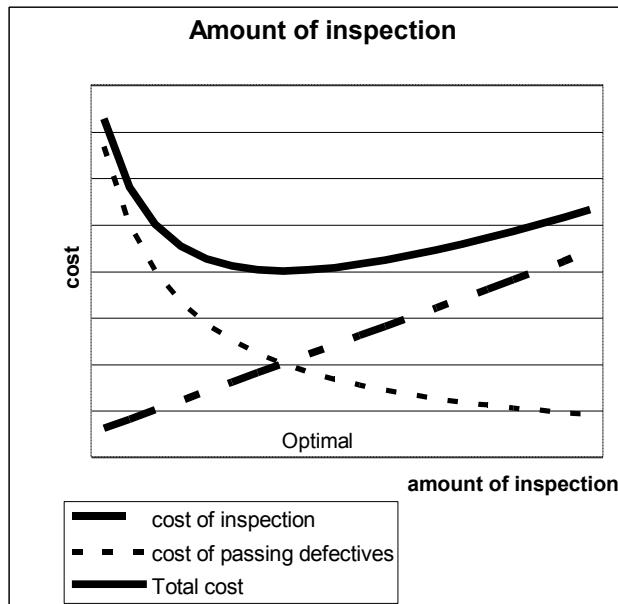

Fig. 5. Amount of inspection

These are only simple examples. The engineers every day use this function. This function is very simple and very usable. If we have a ruler we can optimize this function.

This is why, this is the reason engineers like using the  $(ax^2 + b)/x$  function.

#### REFERENCES

- [1] Arthur R. **Tenner**, Irving J. **DeToro**: Total Quality Management: Three steps to continuous improvement. Addison-Wesley Publishing Company, Inc. USA, 1992.
- [2] Jim **Morgan**: Management for the small design Firm Watson-Gutpill Publications Singapore, 1998.
- [3] Thomas M. **Cook**, Robert A. **Russell**: Contemporary operations management Prentice-Hall, Inc. Englewood Cliffs, N.J. 1980.
- [4] Richard A. **Johnson**, William T. **Newell**, Roger C. **Vergin** : Production and operations management Houghton Mifflin Company Boston, 1974.
- [5] Warren H. **Schmidt**, Jerome P. **Finnigan**: TQM manager Jossey-Bass Inc. San Francisco, California, 1993.
- [6] William J. **Stevenson**: Production/ operations management Addison-Wesley Publishing Company, Inc. USA, 1992.



## **VALUES, HARMONY, SOCIAL AND ARMY**

The countries of Central Europe have successfully implemented procedural democracy through the simultaneous transformation of their economic, political, social, legal and constitutional, and military structures. This stands in contrast to the experiences of the countries of Southern Europe (Greece, Spain, Portugal) which underwent recent transitions to democracy, but which sought to first transform their democratic structures and delay the more difficult and politically costly reforms relating structural economic change until the situation in the country became stabilised. The simultaneity of Central European reforms across all main sectors has made the task of defence reform all the more challenging, as the defence and military sector must contend with competing social and economic priorities. Such a context, I believe, highlights both the degree of commitment to reforms and the extent of success the Central and Eastern European countries have already experienced.

The progress of defence reform in the region has also been confirmed by the commitment shown by military and political elites to democratic political structures and processes. Many of the constitutional, legal, and administrative requisites for civil control or supremacy over the armed forces have been implemented, and while there continues to be fine-tuning of the specific processes and mechanisms of defence management in these democratic polities.

The modern military professional is thus like Janus in having two faces looking in opposite directions: he is both a technical expert (upholding the principle of non intervention in difficult affairs) and a bureaucrat (characterised by corporatism, which in difficult times may stimulate a form of intervention to advance institutional interests). Seeking to protect the organisation, (possessing professional expertise or authority) and constitutes a huge bureaucracy, characterised by corporate tendencies. Normally committed to protecting the national security of its client, the nation (and not intervening), instability or corruption may lead the military professional to intervene. The professional soldier's military corporatism holds the key to modern civil-military relations.

## DEMOCRATIC CONTROL OF THE ARMED FORCES

In Hungary only a relatively more narrow strata (older, religious, low existence level, more immobile country inhabitants) preserved the former specific traditional attitudes toward the military.

They could accept a higher prestige of military professions is appreciated by the public. They could accept an above average salaries of the professional soldiers and prefer their traditional institutional tendencies and conditions as far as their job is concerned. In their respect the military is relatively influential and seen as a guard of national sovereignty. Their opinion is supportive and considers the military as a school at nation. In this relation is supportive and considers the military as a school at nation. In this relations the soldiers or former soldiers military seem to be the most authentic experts in military and security issues. As it concerned the perspectives, the future looks like undoubtedly: the older generation's attitudes are much more supportive toward the military than the younger generations.

After the system-changing, new political elite destroyed military-party relations and proclaimed the military as an apolitical national institution in Hungary too. It was a beginning of a division at authority between the president and the government, parliamentary oversight, civilian ministers and defence were appointed and peacetime governmental control of the general staff was introduced. However the progress made in Hungary — similar to the other CEE countries — didn't yet meet all democratic control requirements, sometimes looked like more symbolic than real. This problem was symbolised by such scandals as: the failure of the prime minister's initiative to the president in the time of strike at taxi drivers in 1990, the protest steps on the side of army commander general Kálmán Lőrincz, the media campaign against the defence government on the mistakes were done concerning the air-force exercise abroad etc.

Main problems can be noticed as the followings:

It was possible to register the legal and constitutional ambiguities mainly the unclear definitions of division of power especially between the president and government, or the minister of defence and the chief of general staff. Additional problems were implementation of existing law and the different interpretation by the different consultation officials persons. During a longer process still now we can register an essential progress on this field, in some extent due to the hope to be invited to become a NATO member.

It was a lack of knowledgeable civilian experts. The lack of supportive civilian experts was enhanced by low societal and political interest in military issues as well as underdevelopment of civilian expertise on defence and security fields.

Some of the military leaders while misunderstood the protection of defence interests they resented many measures establishing democratic control principles.

Against some experts opinion that promoting democratic control is becoming more of tactic than a genuine strategy and that there is continuing discrepancy between the structure and reality of civilian oversight I have to emphasize that the establishing of the entire democratic control principles.

Against some experts opinion that promoting democratic control is becoming more of tactic than a genuine strategy and that there is continuing discrepancy between the structure and reality of civilian oversight, I have to emphasize that the establishing of the entire democratic control is a long-lasting process and finding out solutions is influenced by many cultural, historical and economical factors. In my private prognosis patience will be necessary also in the near future.

## VALUES

- The professional Army ethic is the set of values that guide the way we live our lives and perform our duties. The essential values of our professional ethic are:
  - *Loyalty*: Loyalty to the nation, to the Army and to the unit. This means supporting the military and civilian chain of command, as well as devoting oneself to the welfare of others.
  - *Duty*: Duty is the legal and moral obligation to do what should be done without being told.
  - *Selfless service*: This means putting the welfare of the nation and accomplishment of the mission ahead of personal desires.
  - *Integrity*: This is the thread woven through the fabric of the professional Army ethic. Integrity means honesty, uprightness, the avoidance of deception and steadfast adherence to standards of behaviour.
- Four individual values strengthen and support the ethical code. They are commitment, competence, candour and courage. Commitment means dedication to carry out all unit missions and to serve the values of the nation, the Army, and the organization. Competence is proficiency in required professional knowledge, skills, and attitudes. Candour is being frank, open, honest, and sincere with soldiers, seniors, and peers. Courage comes in two forms. Physical courage is overcoming personal fears of



bodily harm and doing your duty. Moral courage is overcoming fears of other than bodily harm while doing what ought to be done.

## IMPORTANCE OF BELIEFS, VALUES AND NORMS

Beliefs, values, and norms guide the actions of individuals and groups. They are like a traffic control system; they are signals giving direction, meaning, and purpose to our lives.

Beliefs, values, and norms have great motivating power. Respected leaders of strong and honourable character are able to influence the beliefs, values, and norms of their soldiers. As a professional, you are sworn to use your power for the good of the country, the Army, and those you lead.

The professional Army ethic contains the values that guide the way leaders should carry out their professional responsibilities. The elements of the professional Army ethic are loyalty to the nation, the Army, and the unit, duty, selfless service and integrity.

When faced with a situation where the right ethical choice is unclear, consider all the forces and factors that relate to the situation and then select a course of action that best serves the ideals of the nation. The ethical decision making process is a way to resolve those dilemmas.

Individual values, beliefs and attitudes are shaped by past experiences involving such things as family, school, work and social relationships. Leaders must understand the importance of nurturing and shaping belief and values in their subordinates because they are fundamental motivating factors.

## INFLUENCING BELIEFS, VALUES, AND NORMS

As a leader, you have the power to influence the beliefs and values of your soldiers by setting the example; by recognizing behaviour that supports professional beliefs, values and norms; and by planning, executing, and assessing tough, realistic individual and collective training,

Tough training does not mean training in which leaders haze or yell at troops in an effort to cause artificial stress. This merely creates an antagonistic atmosphere of “us against them”. This kind of leadership does not succeed in combat, so why practice bad habits. Tough training occurs when leaders and soldiers mutually experience realistic, exhausting conditions that prepare both, as a team, for the stress of combat. Reform of civil-military relations and introducing democratic control in Hungary appeared as the crucial issues facing

new political elite, as well as military and civil society. Civil military relations include at least the involvement's of the institutions of three classical power branches (legislation, governments, jurisdiction), partly within them separately the defence and military governmental relations (think about both central and local governments). Beside them as other sectors of the CMR system we have to speak about the social factors, one side the civil society (laic citizens and their civil society organizations) and other side the military society, or the society of soldiers with its integrating organizations. Between this two fundamental politico-governmental and societal subsystems we have to mention the very important, so called mediator zone to say the publicity with its key institutions of the electronic and press media. This very difficult multilevel and multifunctional system is under which we can find the armed forces in Hungary too.

I am convinced that during the empirical characterisation of this system it is not enough to take the wellknown Chris Donnelly slogan that "a country which has no problems in civil-military relations and democratic control is a country which has no democracy". On the basis of systematic analysis I have to emphasise that it means not only the logical, continuous tensions between civilians and the military but a lot of other tensions as well within the civilian control system and the controlled military system. This is the reason of it, that to build up and work the functional balance of their own inner elements is necessarily very problematic not only for the so called new democracies, but the older democracies too. I think we have to accept that the overemphasis of civil-military tensions were very functional during the system changing, mostly its beginning period, until finding the new position of armed forces within the new democratic system. But today the same overemphasis of the tensions only in civil-military relations can paralyse the energy and prevent us for stepping forward. It can be a new obstacle on the road of building up the necessary details, it can curtail the responsibilities of the different elements of both civilian and military side.

According to the empirical facts, we have the basically built up democratic type CMR system and our armed forces work under democratic control. And if we are able to enforce the efficiency of elements within both controlling and controlled systems, we could step forward in the quality of relations between civilian and militaries, seeing that the quality of relations and the solving of tensions depend upon channels which are able or not able to overcome these tensions.



## **MODELS OF CHANGING ORGANISATIONAL CULTURES ADEQUATE TO THE REORGANISATION OF THE HUNGARIAN DEFENCE**

### **TIES BETWEEN ORGANISATIONAL CULTURE AND CHANGE MANAGEMENT**

Organisational and management expectations, the behaviour of the organisational members and the values they follow are crucial factors of the culture of that organisation. However, it is difficult to determine what kind of interrelationship there is between the successful change and the culture of the organisation. When analysing culture, it is a dominant viewpoint if it is a strong or a weak culture that exists in the organisation. In case the organisational culture is weak, it is highly possible that the subcultures, i.e. the cultures of organisational units become strong. In case of a strong culture, members will accept its basic values that will trigger their everyday activities. Whether it is the culture of the whole organisation or that of its parts that is dominant, it will strengthen the need for stability on the organisational or sub-organisational level. In that respect, either of them can be a hindrance to the success of organisational change. Many think organisational culture represents an important power in the organisation (see e.g. Kotter 1996). In their opinion, this power has three sources:

- the existence and workings of the selection and socialisation subsystem;
- the fact that it works through people's actions within the organisation;
- the fact that it is subconscious, therefore it is difficult to influence.

Within today's dynamically changing environmental conditions, the capability for change (that is, for development or, at least, for adaptation), can be decisive to survival. It is no simple task for the manager to build the need for change and renewal into the organisational culture. The acceptance of innovative behaviour on the organisational level can only be the result of a combined modification of a number of cultural characteristics, such as risk-taking, the endurance of conflicts, control, and so on.

Models of cultural change of organisations offer two major lines of action for the manager beside the partial modification or radical change of processes: the wide utilisation of communication channels and human resource management tools helping change. These two areas have the most substantial impact on the members and help form their attitudes towards the change to the more positive.

## THE UTILISATION OF COMMUNICATION CHANNELS IN THE MANAGEMENT OF CULTURAL CHANGE IN THE ORGANISATION OF HUNGARIAN DEFENCE

The change of organisational culture within the process of organisational restructurisation is a strategic issue. The furthering or hindering effect of culture can be decisive for single actions as well as for the whole of the process. Grove (1998) states that success may, in many cases, depend on accurately communicating the managerial decision concerning the change. Kotter (1996) expresses the same opinion and offers a wide range of communication channels (from posters through the media to round-table discussions) as tools to be used by management.

The acceptance of change requires the building of an organisational culture that accepts, on occasions even requires the renewal of the organisation. To reach such an attitude, a wide range of communication is needed. As the change is of importance for the managers too, it can be helpful if they find personal contact to the employees of the organisation. The individual opinions and attitudes of the members, as a result of the socialisation process, influence the organisational culture. Therefore, it is of primary importance for the manager to get first hand information at the start of the change, that is possible only by way of direct communication.

The steps towards changing organisational culture of the Hungarian Defence have not been backed up by the necessary communication in the course of the recent reform actions. The communication activities of the Hungarian Defence was limited to a rather ineffective statements targeting the society. Under the first two governments after the political changes, the external communication of the Army concentrated on (rather painful and weak) commentaries and explanations concerning scandals in and around it and the shortening of the service time of the enlisted soldiers, and practically that was it. Neither the professional nor the popular military magazines and journals enjoy much reputation with civilian readerships. The posters, television, radio and newspaper advertisements recently seen have been serving exclusively the purpose of recruiting contractual soldiers and have nothing to do with the formation of

culture. A positive internal communication supporting the cultural change of the organisation is lacking.

Neither the communiqués of top military leaders announcing the abolition, rationalisation or dislocation of various units can be taken for communication aiding the cultural change of communication - they were restrained to the dry facts without trying to show a way for the remaining or encouraging them. Not even they did not help start a healthy change of culture, but also destroyed the still existing positive features of the culture of the military units. The leaders of the Hungarian Defence did not make use of the opportunities offered by communication to form the Army's organisational culture.

## HUMAN RESOURCES MANAGEMENT AS A SUPPORT OF CHANGE MANAGEMENT IN THE HUNGARIAN DEFENCE

In the course of the past ten years of military reform, pompous slogans like “our people are the key factor to the future” and others were aired in each stage of the organisational change. Reality, however, showed something different. From documents dealing with human resources in the Army and opinions set forth at various platforms it became clear that it is difficult to do more than uttering such statements in an organisation where its peculiarities allow only a slow pace for changing operational processes and organisational culture. If there is no dominant culture in the Army, if the rapid change of values is a main quality of the age we are living in, if it is impossible to directly measure organisational effectiveness and have no well-formed system of budgeting and control, development will be slow whatever environmental coercive factors are in effect. Values dumped on army members by expectations based on nostalgic memories of officers of the Second World War, emigrants returning home, reactivated officers, etc. led to resistance or indifference in the organisation.

NATO requirements and internal auditing showed that the management of human resources of defence is especially weak. Professionalism in this field cannot dominate due to the counter-selectivity of the decision mechanism. The analysis of social consequences has usually been missing. A further source of problems is that central human resource planning has not covered the strategic issues of the revitalisation of the remaining staff.

The lack of comprehensive analytical and evaluation systems and the repeated failure to set them up are responsible for the fact that there is no feedback pool for information on the capabilities of the personnel. Therefore there has been no

chance for giving a realistic assessment of the effectiveness of the whole organisation or individual parts of it.

This has influenced on the changing culture of the Army as well. Social impacts (unemployment, economic instability, the lack of political endorsement) wiped away positive features of the character of military culture, while negative social influences (fear of losing the job and/or social status, excessive concentration on individual financial interests, egotistic introversion, etc.) have found an easy way into it.

Human resources management in the Army has not yet got over the level of personnel administration. Personnel offices do not have an integrated information database on the staff. Decisions in this field are born on the basis of relationships and power. The human resources subsystem that should intensively support cultural change in the organisation of Hungarian National Defence does not exist.

## STRATEGIES OF ORGANISATIONAL CHANGE IN THE HUNGARIAN NATIONAL DEFENCE AND THE CHANGE OF CULTURES

The army reforms of the past decade brought forward a quantitative reduction of the organisation. Operational processes speeded up both in the Army and in the society. Shortage of resources became the representative feature of all parts and sections of the military. The Army has used up its reserves - there is no fuel for flying, no replacement for wrong parts, pilots feel stranded as a sea captain in harbour service.

As mentioned above, social impacts demolishing cultural values have reached the organisational culture of the National Defence in abundance after the political changes. Neither the political, nor the military leadership has taken steps to revitalise it. Spontaneous processes of cultural change and the alteration of values forced by various power groups have led to a distortion in the military culture. The military leadership of this era has not been able to create a new cultural value system that would positively influence the functioning of the organisation. The "Socialist" value system was torn out of the culture of the defence forces and its replacement with a "Democratic" one has been without success. The values and norms present in the organisation, however, are blocks that should be used to form a new culture. Forming and managing organisational culture is a management task that is by no means impossible. There exists a pretty rich management literature on cultural change that is taken for a long-term strategic issue of organisational leadership. Nowadays, when in all modern

182

armies of the world it is the human individual (and not the technology) that is held for the key factor of effective military operations, the Hungarian Defence Forces have no other way to go.

#### LITERATURE

- [1] ANGYAL, Á.: A vezetés mesterfogásai. Kossuth Kiadó, Budapest, 1999.
- [2] BAKACSI, GY.: Szervezeti magatartás és vezetés. Közgazdasági és Jogi Könyvkiadó, Budapest, 1996.
- [3] GROVE, A.S.: Csak a paranoidok maradnak fenn. Bagolyvár Könyvkiadó, Budapest, 1998.
- [4] KOTTER, JOHN P.: Leading Change; Harvard Business School Press Boston, Massachusetts, 1996.
- [5] DR. MARTINKÓ, JÓZSEF: Felnőttképzés a Magyar Honvédség humán erőforrás gazdálkodásában; kézirat, 2000.





## LEVELS OF LEADERSHIP

Leadership has been defined by many different disciplines in the past. There are psychological, interpersonal, and sociological concepts of leadership in the behavioral sciences; there are historical, allegorical, and fictional examples in the humanities; and there are obvious assumptions in microeconomics, operations research, and quantitative finance.

### A DEFINITION OF LEADERSHIP FROM THE CIVILIAN ORGANISATION

To develop a useful definition of leadership, we must first understand three related concepts: power, influence, and authority. *Power* is the potential ability to affect the behavior of others. Power is generally related to the control of valued or scarce resources. *Influence* exists when a person consciously or unconsciously exercises power to affect the behavior or attitudes of someone else. *Authority* is power created and granted by an organization.

The most management writers agree that leadership is *the process of influencing the activities of an individual or a group in efforts toward goal achievement in a given situation*. From this definition of leadership, it follows that the leadership process is a function of the *leader*, the *follower*, and other *situational* variables —  $L=f(l,f,s)$ . It is important to note that this definition makes no mention of any particular type of organization. In any situation where someone is trying to influence the behavior of another individual or group, leadership is occurring. Thus, everyone attempts leadership at one time or another, whether his or her activities are centered around a business, educational institution, hospital, political organization, or family.

It should also be remembered that when this definition mentions leader and follower, one should not assume that we are talking only about a hierarchical relationship such as suggested by superior (boss) /subordinate. Any time an individual is attempting to influence the behavior of someone else, that individual is the *potential leader* and the person he or she is attempting to influence is the *potential follower*, no matter whether that person is your “boss,” a colleague (associate), a subordinate, a friend, or a relative. It is reality in the Army too.

## DEFINITIONS FROM THE USA ARMY

- a.) Leadership is the process of influencing others to accomplish the mission by providing purpose, direction, and motivation. Effective leadership transforms human potential into effective performance.
- b.) Management is the process of acquiring, assigning priorities to, allocating, and using resources (people, money, materiel, facilities, information time, etc.) in an effective and efficient manner.
- c.) Leader development is a process. It is the preparation of military and civilian leaders, through a progressive and sequential system of institutional training, operational assignments, and self development, to assume leader positions and exploit the full potential of present and future doctrine.
- d.) Command is the legal authority vested in an individual appointed to a position in the chain of command. Command carries with it special powers of responsibility and accountability which are associated with the position.

### Some important notice

Our leaders today must meet the challenges of an increasingly turbulent and complex environment, particularly as this complexity changes the nature of warfare. Some leaders in the past, as well as a number of contemporary ones, have adopted and applied successfully a systems approach to leadership. This chapter intends to codify this concept, in the hope of increasing the competence of leaders who will be exercising their responsibilities in the future. The greatest significance of the systems concept is its reinforcement of an important but often misunderstood construct: leadership skills vary by organizational. level This is illustrated in the next figure:

### Leadership skills

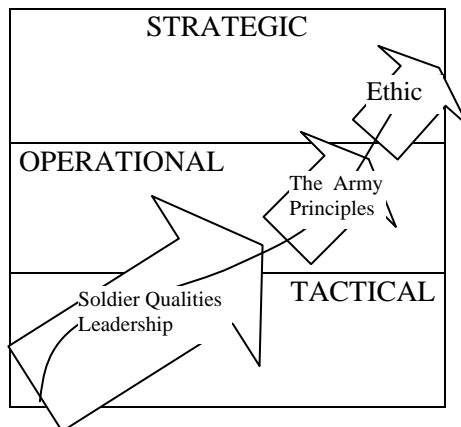

The Peters and Waterman study, *In search of Excellence* (1982), identifies eight attributes of excellent organizations. Restated for the military, these eight attributes are:

- 1.) *Active participation.* Do it yourself until it works.
- 2.) *Responsiveness to the commander.* Do whatever the commander needs done.
- 3.) *Power down.* Cultivate initiative and the freedom to try.
- 4.) *Achievement through the efforts of others.* The rank and file are the source of quality; reward it.
- 5.) *Performance, excellence.* Be the best that you can be.
- 6.) *Adherence to the mission.* Define the individual's mission in relation to the organization's mission.
- 7.) *Simple form, lean staff.* Communicate to solve the problem without letting layers of staff or organizational charts confuse that communication.
- 8.) *Centralized planning, decentralized execution.* Solve problems at the lowest possible level; planning originates at the top, but permeates all levels.

Our leaders must now lead an informed soldier rather than an uninformed one. This challenge is greatest at the Army. Here, traditional hierarchical structures and command and control techniques (e.g., C<sup>3</sup>I: Command, Control, Communications, and Intelligence) give way to more organic structures with control based upon consensus and distributed data bases. Figure displays a prototype of possible future structures. Next:

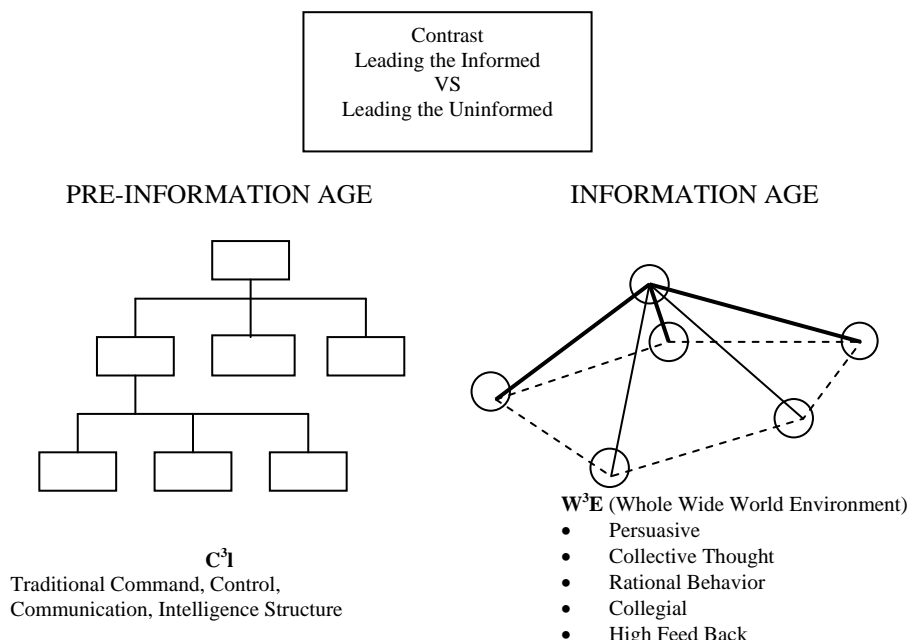

## Levels of leadership at the Army

Total Army leadership policy recognizes three interrelated levels of leadership requirements: direct, senior and strategic. These levels vary in scope and character, and require differing mixes of leadership skills.

- The direct level is the front-line or first level of leadership. This level includes leaders from the squad through battalion levels of tactical units, and from branch through division level in Table of Distribution and Allowances(TDA) organizations. Leadership at this level consists of the skills, knowledge and attitudes which relate to face-to-face, interpersonal leadership that influences human behavior and values. Direct leaders build cohesive teams and empower subordinates. Skills required for effective leadership at this level include technical and tactical competence on individual soldier and leader tasks, problem solving, interpersonal skills, performance counseling, team building, and developing and executing plans that implement policies and accomplish missions. Direct leaders focus on short-range planning and mission accomplishment ranging from three months to one year, or more.
- Senior level leadership exists in more complex organizations. This level includes military and civilian leaders at the brigade through corps levels in tactical units, and directorate through installation level in TDA organizations. Senior leaders tailor resources to organizations and programs and set command climate. Skills required for effective leadership at this level include technical and tactical competence on synchronizing systems and organizations, sophisticated problem solving, interpersonal skills (emphasizing listening, reading, and influencing others indirectly through writing and speaking), shaping organizational structure and directing operations of complex systems, tailoring resources to organizations or programs, and establishing policies that foster a healthy command climate. Senior leaders focus on mid-range planning and mission accomplishment ranging from one to five years, or more.
- The strategic level of leadership exists at the highest levels throughout the Army. This level includes military and civilian leaders at Field Army through national levels. Strategic leaders establish structure, allocate resources and articulate strategic vision. Skills required for effective leadership at this level include technical competence on force structure and integration, unified, joint, combined, and interagency operations, resource allocation and management of complex systems; conceptual competence in creating policy and vision; and interpersonal skills emphasizing consensus building and influencing peers and other policy makers — both internal and external to the organization. Strategic leaders focus on the long-range vision for their organization ranging from 5 to 20 years, or more.

## REFERENCES

- [1] AR. 600-100. Army Leadership.
- [2] FM. 22-100. Military Leadership.
- [3] FM. 22-103. Leadership at Senior Levels.
- [4] Griffin: Management. Houghton Mifflin Company, 1976.
- [5] Hersey and Blanchard: Management of organizational Behavior. Prentice-Hall, 1977.
- [6] Hunt and Blair: Leadership on the future battlefield. Pergamon – Brassey's, 1985.
- [7] Thompson - Strickland III – Fulmer: Readings in srtrategic management. Business Publications, inc. 1984.



Bányai Kornél

## **MILITARY BACKGROUND AND LEADERSHIP SKILLS IN THE BUSINESS LIFE**

Leaving the army – not a new matter in our life. All army leavers (officers) have higher education with very strong leadership skills. They have to find new career opportunities in civilian life without any experiences in that field. What does this mean in terms of leadership skills? How can these skills help in business life?

This publication would describe the most characteristic features of demobilized officers.

Leadership has many aspects. Due to the limited size of this article the goal now to describe what the military leader must be, know and do by means of military leadership framework and how these properties can influence the ex-officer's career in business life, how these properties succeed there, how business appreciate those skills.

The army's ultimate responsibility is to win wars, to defend the country against enemies, ensure the security of the land. Leadership in combat is the primary mission and most important challenge. To meet this challenge an officer should develop his character and competence while achieving excellence. It focuses on character, competence and excellence.

Leadership starts at the top, with the character of the leader. In order to lead others an officer must first make sure his own house in order. Army leadership begins with what the leader must be, the values and attributes that shape a leader's character. But character and knowledge — while absolutely necessary — are not enough. An officer cannot be effective, cannot be a leader, until he applies what he knows, until he acts and does what he must. As with skills, he will learn more leadership actions as he serves in different positions. Because actions are the essence of leadership, the discussion begins with them.

### **LEADERSHIP DEFINED**

Leadership is influencing people – by providing purpose, direction, and motivation – while operating to accomplish the mission and improving the organization. This definition is the same in the civilian life as well, valid in every kind of organizations.

In military perspective leadership doctrine has 3 major elements:



- Influencing: making decisions, communicating those decisions, and motivating people
- Operating: the things you do to accomplish your organization's immediate mission
- Improving: the things you do to increase the organization's capability to accomplish current or future missions.

First of all we have to define these elements from the army's point of you.

## INFLUENCING

Influencing means getting people to do what you want them to do. It is the means or method to achieve two ends: operating and improving. But there's more to influencing than simply passing along orders. The example the officer sets is just as important as the words he speaks. And officer sets an example – good or bad – with every action. Influencing actions fall into these categories: communicating, decision making, motivating. Through the officer's words and example, he must communicate purpose, direction and motivation.

### **Purpose**

Purpose gives people reason to do things. This does not mean that as a leader the officer must explain every decision to the satisfaction of his subordinates. It does mean he must earn their trust: they must know from experience that the officer cares about them and would not ask them to do something — particularly something dangerous — unless there was a good reason, unless the task was essential to mission accomplishment.

### **DIRECTION**

When providing direction, an officer communicates the way he wants the mission accomplished. Prioritize tasks, assign responsibility for completing them (delegating authority when necessary), and make sure your people understand the standard. In short, the officer figures out how to get the work done right with the available people, time, and other resources; then he communicate that information to his subordinates. As he thinks the job through, he can better aim his effort and resources at the right targets.

People want direction. They want to be given challenging tasks, training in how to accomplish them, and the resources necessary to do them well. Then they want to be left alone to do the job.

## **MOTIVATION**

Motivation gives subordinates the will to do everything they can to accomplish a mission. It results in their acting on their own initiative when they see something needs to be done.

To motivate the people, officer should give them missions that challenge them. Get to know the people and their capabilities; that way you can tell just how far to push each one. An officer should give them as much responsibility as they can handle; then let them do the work without looking over their shoulder and nagging them. When they succeed, they should be praised. When they fall short, credit should be given for what they have done and coach or counsel them on how to do better next time.

People who are trained this way will accomplish the mission, even when no one is watching. They will work harder than they thought they could. And when their leader notices and gives them credit (with something more than the offhand comment „good job”), they will be ready to take on even more next time.

But army leaders motivate their people by more than words. If his people are working in the rain, the officer’s uniform will be wet too. If they have missed breakfast, the leader’s stomach will be growling just as loudly. The best leaders lead from the front. They don’t underestimate the importance of being where the action is.

## **OPERATING**

Operating is what the officer does to accomplish the immediate mission, to get the job done on time and to standards. Actions taken to influence others serve to accomplish operating actions, those actions you take to achieve the short-term goal of accomplishing the mission. All military leaders execute the operating actions, which become more complex as they assume positions of increasing responsibility. Operating actions fall into the following categories: planning and preparing, executing and assessing.

## **IMPROVING**

The army also expects from the officers to do far more than just accomplish the day’s work. Army leaders also strive to improve everything entrusted to them: their people, facilities, equipment, training and resources. There will be a new mission, of course, but part of finishing the old one is improving the organization. Good leaders strive to leave an organization better than they found it.

Army leaders set priorities and balance competing demands. They focus their organization's effort on short- and long-term goals while continuing to meet requirements that may or may not contribute directly to achieving those goals.

By doing these things the officer is creating a better organization, one that will work smarter the next time. His example sends an important message. The soldiers see their leader look at their own and the organization's performance, evaluate it, identify strong areas to sustain as well as mistakes and shortcomings, and commit to a better way of doing things. These actions are more powerful than any lecture on leadership.

Improving actions fall into these categories: developing, building, learning.

## INDICATORS

After this short summary of military leadership framework we have to define those properties which are most useful in business life. In order to achieve that it is reasonable to describe the most military properties. At this stage I used the indicators from US Army Field Manual No. 22-100.<sup>1</sup>

During the previous years I made investigations among headhunting companies in Hungary asking them, how they evaluate, appreciate the logistics professionals. In the previous months I repeated this investigation but now with strong focus on leadership skills of the ex-military staff.

I gave them the list below, and asked them to indicate the most typical elements of the ex-military leaders behavior according to their experiences. (The most relevant answers are indicated with italics letters.)

## ACTIONS

### *Influencing*

- *Use appropriate methods to reach goals while operating and improving.*
- *Motivate subordinates to accomplish assigned tasks and missions.*
- *Set the example by demonstrating enthusiasm for—and, if necessary, methods of—accomplishing assigned tasks.*
- Make themselves available to assist peers and subordinates.
- *Share information with subordinates.*
- Encourage subordinates and peers to express candid opinions.
- *Actively listen to feedback and act appropriately based on it.*
- Mediate peer conflicts and disagreements.

---

<sup>1</sup> Army leadership – Be, Know, Do (Field Manual No. 22-100 US Army, 31 August 1999).

- *Tactfully confront and correct others when necessary.*
- Earn respect and obtain willing cooperation of peers, subordinates, and superiors.
- Challenge others to match their example.
- *Take care of subordinates and their families, providing for their health, welfare, morale, and training.*
- Are persuasive in peer discussions and prudently rally peer pressure against peers when required.
- Provide a team vision for the future.
- *Shape the organizational climate by setting, sustaining, and ensuring a values-based environment.*

### **Communicating**

- *Display good oral, written, and listening skills.*
- Persuade others.
- *Express thoughts and ideas clearly to individuals and groups.*

### **Oral Communication.**

- Speak clearly and concisely.
- Speak enthusiastically and maintain listeners' interest and involvement.
- *Make appropriate eye contact when speaking.*
- Use gestures that are appropriate but not distracting.
- Convey ideas, feelings, sincerity, and conviction.
- Express well-thought-out and well-organized ideas.
- Use grammatically and doctrinally correct terms and phrases.
- Use appropriate visual aids.
- *Act to determine, recognize and resolve misunderstandings.*
- *Listen and watch attentively; make appropriate notes; convey the essence of what was said or done to others.*
- *React appropriately to verbal and nonverbal feedback.*
- *Keep conversations on track.*

### **Written Communication.**

- Are understood in a single rapid reading by the intended audience.
- Use correct grammar, spelling, and punctuation.
- Have legible handwriting.
- *Use the active voice.*
- *Use an appropriate format, a clear organization, and a reasonably simple style.*
- Use only essential acronyms and spell out those used.

- *Stay on topic.*
- *Correctly use facts and data.*

### **Decision Making**

- *Employ sound judgment and logical reasoning.*
- *Gather and analyze relevant information about changing situations to recognize and define emerging problems.*
- *Make logical assumptions in the absence of facts.*
- *Uncover critical issues to use as a guide in both making decisions and taking advantage of opportunities.*
- *Keep informed about developments and policy changes inside and outside the organization.*
- *Recognize and generate innovative solutions.*
- *Develop alternative courses of action and choose the best course of action based on analysis of their relative costs and benefits.*
- *Anticipate needs for action.*
- *Relate and compare information from different sources to identify possible cause-and-effect relationships.*
- *Consider the impact and implications of decisions on others and on situations.*
- *Involve others in decisions and keep them informed of consequences that affect them.*
- *Take charge when in charge.*
- *Define intent.*
- *Consider contingencies and their consequences.*
- *Remain decisive after discovering a mistake.*
- *Act in the absence of guidance.*
- *Improvise within commander's intent; handle a fluid environment.*

### **Motivating**

- *Inspire, encourage, and guide others toward mission accomplishment.*
- *Don't show discouragement when facing setbacks.*
- *Attempt to satisfy subordinates' needs.*
- *Give subordinates the reason for tasks.*
- *Provide accurate, timely, and (where appropriate) positive feedback.*
- *Actively listen for feedback from subordinates.*
- *Use feedback to modify duties, tasks, requirements, and goals when appropriate.*

- *Recognize individual and team accomplishments and reward them appropriately.*
- *Recognize poor performance and address it appropriately.*
- *Justly apply disciplinary measures.*
- *Keep subordinates informed.*
- *Clearly articulate expectations.*
- *Consider duty positions, capabilities, and developmental needs when assigning tasks.*
- *Provide early warning to subordinate leaders of tasks they will be responsible for.*
- *Define requirements by issuing clear and concise orders or guidance.*
- *Allocate as much time as possible for task completion.*
- *Accept responsibility for organizational performance. Credit subordinates for good performance. Take responsibility for and correct poor performance.*

## **OPERATING**

- *Accomplish short-term missions.*
- *Demonstrate tactical and technical competency appropriate to their rank and position.*
- *Complete individual and unit tasks to standard, on time, and within the commander's intent.*

### **Planning and Preparing**

- *Develop feasible and acceptable plans for themselves and others that accomplish the mission while expending minimum resources and posturing the organization for future missions.*
- *Use forward planning to ensure each course of action achieves the desired outcome.*
- *Use reverse planning to ensure that all tasks can be executed in the time available and that tasks depending on other tasks are executed in the correct sequence.*
- *Determine specified and implied tasks and restate the higher headquarters' mission in terms appropriate to the organization.*
- *Incorporate adequate controls such as time phasing; ensure others understand when actions should begin or end.*
- *Ensure all courses of action accomplish the mission within the commander's intent.*

- Allocate available resources to competing demands by setting task priorities based on the relative importance of each task.
- *Address likely contingencies.*
- Remain flexible.
- *Consider SOPs (standard operation procedures)*
- Coordinate plans with higher, lower, adjacent, and affected organizations.
- *Personally arrive on time and meet deadlines; require subordinates and their organizations to accomplish tasks on time.*
- *Delegate all tasks except those they are required to do personally.*
- *Schedule activities so the organization meets all commitments in critical performance areas.*
- *Recognize and resolve scheduling conflicts.*
- *Notify peers and subordinates as far in advance as possible when their support is required.*
- Use some form of a personal planning calendar to organize requirements.

### **Executing**

- *Use technical and tactical skills to meet mission standards, take care of people, and accomplish the mission with available resources.*
- *Perform individual and collective tasks to standard.*
- *Execute plans, adjusting when necessary, to accomplish the mission.*
- Encourage initiative.
- *Keep higher and lower headquarters, superiors, and subordinates informed.*
- *Keep track of people and equipment.*
- Adapt to and handle fluid environments.
- *Fight through obstacles, difficulties, and hardships to accomplish the mission.*
- Keep track of task assignments and suspenses; adjust assignments, if necessary; follow up.
- *Assessing*
- Leaders who effectively assess—
- Use assessment techniques and evaluation tools to identify lessons learned and facilitate consistent improvement.
- *Establish and employ procedures for monitoring, coordinating, and regulating subordinates' actions and activities.*
- Conduct initial assessments when beginning a new task or assuming a new position.

- *Analyze activities to determine how desired end states are achieved or affected.*
- Seek sustainment in areas when the organization meets the standard.
- Observe and assess actions in progress without oversupervising.
- *Judge results based on standards.*
- Sort out important actual and potential problems.
- *Determine causes, effects, and contributing factors for problems.*
- Analyze activities to determine how desired end states can be achieved ethically.

## **IMPROVING**

- Sustain skills and actions that benefit themselves and each of their people for the future.
- Sustain and renew the organization for the future by managing change and exploiting individual and institutional learning capabilities.
- Create and sustain an environment where all leaders, subordinates, and organizations can reach their full potential.

## *Developing*

- *Strive to improve themselves, subordinates, and the organization.*
- *Mentor by investing adequate time and effort in counseling, coaching, and teaching their individual subordinates and subordinate leaders.*
- *Set the example by displaying high standards of duty performance, personal appearance, military and professional bearing, and ethics.*
- Create a climate that expects good performance, recognizes superior performance, and doesn't accept poor performance.
- *Design tasks to provide practice in areas of subordinate leaders' weaknesses.*
- *Clearly articulate tasks and expectations and set realistic standards.*
- Guide subordinate leaders in thinking through problems for themselves.
- Anticipate mistakes and freely offer assistance without being overbearing.
- *Observe, assess, counsel, coach, and evaluate subordinate leaders.*
- Motivate subordinates to develop themselves.
- Arrange training opportunities that help subordinates achieve insight, self-awareness, self-esteem, and effectiveness.
- Balance the organization's tasks, goals, and objectives with subordinates' personal and professional needs.



- Develop subordinate leaders who demonstrate respect for natural resources and the environment.
- Act to expand and enhance subordinates' competence and self-confidence.
- Encourage initiative.
- Create and contribute to a positive organizational climate.
- Build on successes.
- *Improve weaknesses.*

### **Building**

- *Spend time and resources improving the organization.*
- Foster a healthy ethical climate.
- *Act to improve the organization's collective performance.*
- *Comply with and support organizational goals.*
- *Encourage people to work effectively with each other.*
- Promote teamwork and team achievement.
- Are examples of team players.
- Offer suggestions, but properly execute decisions of the chain of command—even unpopular ones—as if they were their own.
- *Accept and act on assigned tasks.*
- *Volunteer in useful ways.*
- Remain positive when the situation becomes confused or changes.
- Use the chain of command and NCO support channel to solve problems.
- Support equal opportunity.
- *Participate in organizational activities and functions.*
- Participate in team tasks and missions without being requested to do so.
- *Establish an organizational climate that demonstrates respect for the environment and stewards natural resources.*

### **Learning**

- *Seek self-improvement in weak areas.*
- Encourage organizational growth.
- Envision, adapt, and lead change.
- *Act to expand and enhance personal and organizational knowledge and capabilities.*
- *Apply lessons learned.*
- Ask incisive questions.
- Envision ways to improve.
- *Design ways to practice.*
- Endeavor to broaden their understanding.

- *Transform experience into knowledge and use it to improve future performance.*
- Make knowledge accessible to the entire organization.
- Exhibit reasonable self-awareness.
- *Take time off to grow and recreate.*
- Embrace and manage change; adopt a future orientation.
- *Use experience to improve themselves and the organization.*

What can we see from the above indicated sentences? The proper answer requires much more detailed investigation, but some of the elements are enough to see, what the business life appreciate in the ex-military staff, which positive elements were mentioned mostly:

- they use appropriate methods to reach goals, they can accept their goals and fight for them honestly, execution is their major strength;
- they set example by demonstrating enthusiasm for accomplishment;
- they share information, actively listen to feedback and tactfully confront and correct others when necessary;
- take care of subordinates, feel their needs, know them well (!!!);
- they display good communication skills, keep conversation on track, use the active voice, stay on topic, keep subordinates informed (they are disciplined!!!);
- they act to determine, recognize and resolve misunderstanding, setting always clear goals;
- make logical assumptions in the absence of facts, anticipate needs for action;
- inspire, encourage and guide (not necessarily motivate!!!!) others toward mission accomplishment, very strong operating skills.

But what are those elements, which are clearly negative in the businessman's eyes? Let us see the weaknesses as well:

- there was no indicated sentence in the improving part at all (!!!);
- they not necessarily use logical reasoning during the discussions ("they are tough guys, giving an order, no place for reasoning!");
- they are not always flexible, too strong connection to SOP's;
- positive organizational climate and motivation underevaluated (due to clearly articulated tasks and expectations);
- performance is much more appreciated than ethics (in case of decision the achievement has primary importance for them);

Are those statements right or coming from stereotypes? Very good question, but to explore that we have to continue the investigation.



## **GRIPEN FOR HUNGARY. WHY THE GRIPEN IS THE BEST SOLUTION**

We would like – in our briefing – to give you a short, but essential overview about the main characteristics of the Gripen, which is a fourth generation, multirole, fighter aircraft.

### **MAIN TECHNICAL AND AERODYNAMIC CHARACTERISTICS**

The main design features are the followings:

- single engine,
- canard-delta wing configuration with relaxed pitch stability and an electronic flight control system,
- extensive use of modern materials, such as carbon fiber composites,
- computer based, integrated and modularised systems,
- extensive use of computers in all aircraft systems.

Past experience in the aircraft maintenance shows, that some 60 per cent of combat aircraft life cycle costs are engine related. The choice of a single engine configuration is thus of great importance in keeping the costs down. In terms of overall aircraft design, it also contributes to reducing visual and infrared signatures as well as, most importantly, radar cross section.

The engine chosen is an improved version of the General Electric F 404-400, given the Swedish designation RM-12. The improvements, developed by Volvo Aero Corporation in co-operation with GE, resulted in 10-15 per cent more thrust, better bird ingestion capability, higher system redundancy and further improvements in modularization and maintainability.

Side located air intakes were chosen instead of belly intake mainly to reduce the radar cross section and engine foreign object damage. They also permit a more forward nose-wheel location for enhanced ground stability during take-offs and landings on short, narrow runways.

The canard-delta configuration, relaxed stability and electronic flight control system offer:

- increased maneuverability in both subsonic and supersonic flight;

- lower trim drag, especially in supersonic flight;
- lower take off and landing speeds;
- efficient landing roll braking and steering;
- lower weight compared to conventional flight control systems,
- possibilities for unconventional flight control and aiming modes.

Approximately 25 percent of Gripen's structure by weight consists of carbon fiber composites. The advantages are primarily lower weight and good fatigue characteristic.

## **The multirole capability**

The three main scenarios with clearly distinct requirements on flight and systems performance can be identified as intercept, close in combat, and strike/reconnaissance missions. The major contributors to the Gripen capability in these roles are:

### *Intercept*

- The PS-05 radar, which can detect and track multiple targets at long range and deliver target data to the weapons system, the pilot's displays and the data link system,
- The small radar cross section, especially in the frontal aspect, obtained both through small physical size and through other measures to reduce radar reflections.
- The data link system provides target data from other Gripens in the area and ground control centres, which can be displayed to the pilot, and integrated with target data from superior tactical situation awareness as well as necessary information for long range interaction between Gripen units.

Full integration of modern medium range missiles capable of sequential launches against multiple targets.

### *Close in combat*

- An efficient man machine interface with weapon and system controls conveniently located on the throttle and control stick /HOTAS/, automatic radar modes for rapid search and lock-on, and the data link with other aircraft.
- Decision support via synthetic voice and tone information, and highly developed situation awareness and weapon aiming symbology on the wide-angle, diffractive-optics head up display.

- An easily maneuverable, high-performance aircraft with high instantaneous and sustained turn rates and high acceleration.
- Provision for a close-coupled cannon aiming mode in which the pilot keeps the target within an “aiming window” and radar derived target data are fed directly to the flight control system, keeping the cannon on the impact point. This allows cannon firing with a high hit probability at long range and at all target aspect angles.
- Good visibility for the pilot, small visual signature for the aircraft and a low smoke emission engine.

### *Strike and reconnaissance*

- Support of advanced stand-off weapons via data bus interface.
- Advanced navigation system support, including ground proximity warning as an aid for high-speed low-level penetration.
- Data linking of tactical information in real or near-real time.
- Use of data link to communicate target positions and the threat situation among radar-silent attacking units and target-designating or reconnaissance units at stand-off distance.
- Provision for Flir navigation and aiming system.
- High self defence capability.
- a comprehensive mission planning system for the pilot to fly and analyse the mission in advance and easily load all mission data to the aircraft via a data transfer unit.

## NATO INTEROPERABILITY

The Gripen aircraft system will be adapted to NATO standards. This gives the aircraft the capability to operate with NATO forces. BAe with its long time experience of deliveries of aircraft to NATO forces will assist in the NATO adaptation of the Gripen.

The following main features contribute to the operational capability of the Gripen in a “NATO theatre”:

- NATO standard fuel connection. The aircraft is designed to use NATO and commercial standard fuels.
- Ground power supply receptacle and phase order comply with NATO standards.
- Duplicated VHF/UHF transceivers with AM and FM modulation capabilities.

- IFF transponder and interrogator will be modified by the Hungarian requirements.
- ILS landing system integration.
- NATO standard weapons loading and carrying.

## OPERATION AND MAINTENANCE

Gripen has excellent flight and handling characteristics. Its radar, the PS-05, uses the latest technology for target acquisition and electronic warfare protection which, combined with the low observation of the aircraft, allows hostile aircraft to be detected before the Gripen itself can be located.

The data link permits tactical information to flow among group of Gripens as well as between the aircraft and ground control centre. This information enhances tactical situation awareness among the pilots, improves operational interaction, and helps each pilot to use his aircraft to maximum efficiency at any given moment. The multi-role capability permits optimum use of each Gripen in response to the particular demands of any tactical situation.

The Gripen aircraft is specially designed for high availability and easy maintenance in order to achieve a high mission rate combined with low operating and maintenance costs.

The Gripen cost killers can be summarised as follows:

- Highly reliable components and material.
- Highly reliable systems-redundancy within systems
- Low aircraft weight-small aircraft
- A single engine
- High flexibility – multirole concept
- Line replaceable unit concept and modular engine
- Built in safety checks
- Built in function monitoring in flight
- Built in fault localisation
- Built in maintenance data recording system
- Minimal, easy to handle ground support equipment
- Easy to access
- minimum maintenance.

The result:

- Low fuel consumption
- Low spare parts need
- Low maintenance work load.

## ADVANTAGES OF THE AIRCRAFT LEASE FOR HUNGARY

In the life cycle cost of each type of aircraft the biggest part is the spare parts and the maintenance. It was clearly shown in accordance with the Mig-29 availability in the recent years. To avoid the similar situation, the Hungarian government signed a contract with the Swedish government, that the lease fee, contains all the spare parts and maintenance costs. Hungary bought only flight hours 120 per aircraft per year. In these case all the aircraft, in every case will be in working condition, and to keep up the agreed level of availability will be the responsibility of the Swedish Air Force. It is the first, and most important advantage of the contract.

The second advantages, that the complete lease fee, which is 108 Bn HUF will be compensate with a 110% offset package. The offset agreement contains, 32 Bn HUF, which will be invested in Hungary by the government designated districts of the country. The other part of the sum of money will be covered by procurements Hungarian made products.

The advantageous lease contract had given for ten years the most up to date, forth generation fighter squadron without aircraft procurement, with very favourable conditions.

## FUTURE POSSIBILITIES

The development of the Hungarian Air Force demand one, or two time more fighter aircraft to meet all the domestic and NATO requirements. In this case, based on the gathered experience of the Gripen operation, will be possible to increase the number of aircraft, and build up a powerful Air force.





## SELECTED ASPECTS OF THE MODERN FIGHTERS EVALUATION

### INTRODUCTION

In available literature on military aircraft evaluations including multirole aircraft, the considered type of aviation is analysed by means of design survey, development trends of selected parameters in some period of time. Some relevant conclusions can be drawn from these evaluations, particularly referring to the present status and development trends of the considered class of the aircraft. Anyway, it is impossible to accomplish a conclusion regarding aircraft assessment, especially from the point of view of their combat capabilities, dominance areas etc. In this paper, a concept of a comprehensive method aircraft evaluation is presented. The method was adapted to the needs of assessment of aircraft combat capabilities using a matrix calculus technique.

### EVALUATION TECHNIQUE

In general, military aircraft are designed to carry out various types of air operations. So, some areas, called the areas of comparison, which are important from the point of view of the task realisation, can be determined. For the contemporary fighters these areas are weapon system, avionics and navigation systems, manoeuvrability, dynamics, service flexibility etc. The mentioned areas as representative of some class, type of fighters should be carefully evaluated through the identification of the relevant parameters representing the investigated area and then some comparison analysis should be carried out.

It can be assumed that  $n$  – is the number of the same class aircraft e.g. fighters, bombers, attacks or trainers, which can be evaluated,  $m$  – is the number of assessed areas determined for these aircraft. Within every selected area some parameters or measurements can be specified and defined. In this way for the  $i$  area parameters:  $a_{i1}, a_{i2}, \dots, a_{ik}$ , were specified ( $k$ -is the number of the defined parameter). It means that a considered aircraft is depicted by  $m$  areas and every area is represented by  $k$  parameters, So  $\mathbf{A}$ -designated aircraft, can be shown as a  $m \times k$  matrix. To put it briefly, an aircraft was described by  $m$  areas, and every

area by  $k$  parameters so, in this way for next aircraft similar matrices – **B**, **C**, **D**,..., **Z** could be created. As it mentioned earlier, every area is depicted by  $k$  dimensional or non-dimensional parameters. What is more, the impact of a parameter on the area must be determined; of course, it could be advantaging or disadvantaging.

$$\mathbf{A} = \begin{bmatrix} a_{11}, & a_{22}, & \dots, & a_{1k} \\ a_{21}, & a_{22}, & \dots, & a_{2k} \\ \dots, & \dots, & \dots, & \dots, \\ a_{m1}, & a_{m2}, & \dots, & a_{mk} \end{bmatrix} \quad (1)$$

After that, for all the considered aircraft, proper areas should be compared. In this case, the matrix representing the considered area comprising all the investigated aircraft is built. We can create  $m$  such type matrices, i.e. as many as the specified areas. For the first area, the matrix is:

$$\mathbf{S}_1 = \begin{bmatrix} a_{11}, & a_{12}, & \dots, & a_{1k} \\ b_{11}, & b_{12}, & \dots, & b_{1k} \\ \dots, & \dots, & \dots, & \dots, \\ z_{11}, & z_{12}, & \dots, & z_{1k} \end{bmatrix} \quad (2)$$

Such composed matrix (2) representing the evaluation areas, which comprises (each of them) all the considered aircraft, should be normalised in a proper way. In a similar way the matrices  $\mathbf{S}_1, \mathbf{S}_2, \dots, \mathbf{S}_m$ , for subsequent areas could be created. Such matrices must be normalised in a proper way. The matrix components are a value from 0 to 1, and at least one of them equals 1. Using the above presented procedure, for the other aircraft areas,  $m$  aircraft matrices can be created. Such created matrices should be used for designing of separate matrices regarding every aircraft and comprises all the specified areas. So, for the first aircraft the  $\mathbf{A}$  matrix has the following form:

$$\bar{\mathbf{A}} = \begin{bmatrix} \bar{a}_{11}, & \bar{a}_{12}, & \dots, & \bar{a}_{1k} \\ \bar{a}_{21}, & \bar{a}_{22}, & \dots, & \bar{a}_{2k} \\ \dots, & \dots, & \dots, & \dots, \\ \bar{a}_{m1}, & \bar{a}_{m2}, & \dots, & \bar{a}_{mk} \end{bmatrix} \quad (3)$$

Similar to the matrix (1) but with non-dimensional components. The number of the matrices (3) is determined by the number of the evaluated aircraft. These matrices are the essential base for the final evaluations. Using the matrices (3), an analysis of selected aircraft areas as well as the final aircraft ranking can be made. In cases, (area, aircraft) the final score is the result of aggregation of the fraction scores. For an area the result is the sum of the component values of the proper matrix rows line of the **A**, **B**, **C**,..., **Z** matrices, which be can written as:

$$L_{iA} = \overline{a_{i1}} + \overline{a_{i2}} + \dots + \overline{a_{ik}} = \sum_{j=1}^k \overline{a_{ij}}$$

$$L_{iZ} = \overline{z_{i1}} + \overline{z_{i2}} + \dots + \overline{z_{ik}} = \sum_{j=1}^k \overline{z_{ij}}$$
(4)

for  $i=1,2,3,\dots, m$  areas

An aircraft holds superiority within the  $i$  area, when the following formula is met:

$$L_{i,\max} = \max(L_{iA}, L_{iB}, \dots, L_{iZ})$$
(5)

for  $i=1,2,3,\dots, m$  areas

Implementing a similar procedure for the aircraft i.e. aggregating values of all the considered areas according to (5) we can obtain the values of the consecutive aircraft taken into consideration. An aircraft is superior when reach its maximum:

$$L_{\max} = \max(L_A, L_B, \dots, L_Z)$$
(6)

Numerical values obtained from formulas (5) and (6) we can use as the base for the other areas and the aircraft as well. In this way we can fix a value from 0 to 1 for all the areas and aircraft, and also the areas and aircraft can be made up. Moreover, the aircraft with the best capabilities within the specified areas can be identified e.g. area of combat capabilities, survivability area etc. What is more, some relations between the evaluated aircraft, from the point of investigated areas can be given.

## SAMPLE OF FIGHTERS EVALUATION

Combat capability means the ability to destroy aerial and surface targets by an aircraft with proper technical and tactical features. In this work, considerations were limited to the air-to-air operation. A group of selected modern multirole

fighters were the object of analysis, while the goal was the comparison some features, that are essential for combat capabilities. According to the method requirements some significant areas should be determined for these class aircraft. The areas are manoeuvrability, aircraft dynamic properties, weapon system, avionics, service flexibility etc. In the paper, presented comparison samples are limited to two selected areas, i.e. manoeuvrability and dynamic properties.

### **Manoeuvrability**

This feature is a key factor in a close-in dogfight where a manoeuvrability and fire at short distance are essential. Manoeuvrability is understood as the ability to rapid change the aircraft location, i.e. speed, altitude and flight direction.

Seven parameters were employed for evaluation of this area. Their values for evaluated aircraft are presented in Table 1. They are significant and relevant for this class of aircraft. However, some comments to these parameters is required; normal take off mass is taken as an aircraft mass, in the case of an aircraft with lifting fuselage, the fuselage was added to a general aircraft surface. The inertial moment  $I_y$  is given as non-dimensional and refers to the MiG-29(9-12)  $I_y$  moment. It was assumed that  $I_y = 1$  for the MiG-29. The data from table 1 are essential for evaluation of considered area. According to the technique presented in paragraph 2, all the dimensional parameters were normalised in proper way to non-dimensional form. As a consequence, the evaluated fighters can be ranked following the manoeuvrability, see Fig.1.

### **Dynamic properties**

In available literature there is a lack information about dynamic characteristics, especially important from point of view of acceleration and deceleration times, rate of climb, scramble time etc. For estimation of dynamic properties, some factors may be used, which could be determined generally on the basis of the reliable resources. These factors can presented in the form of e.g. thrust to lifting surface ratio, see Fig.2. Russian aircraft from Suchoy and Mikoyan design bureaus have advantage over the others. It is the result of their huge power; thrust surplus, especially with afterburner (e.g. the MiG-21bis) and very precisely designed aerodynamic shape of the aircraft (e.g. the MiG-29, Su-27). It should be pointed out, that the top scored aircraft in this area, is superior to the others in view of acceleration and energy as well. It allows among the other things for determination how the aircraft is capable to change altitude, speed, and so on.

## CONCLUDING REMARKS

In a short form, a comprehensive method of aircraft assessment was presented and its utilisation to combat capabilities. In this case, only two sample areas were determined from the point of view of examined features. Selected areas were defined by representative factors, which were used for the aircraft evaluation, on the assumption that all the factors were equivalent in hierarchy. Then, the areas scores were cumulated in the form of the final ranking. The combat capability assessment was done for an equivalent scale of the examined areas. In practise, for a much more comprehensive analysis, all the fighter areas should be examined (only two in this paper) with variable, differ scales.

Manoeuvrability ranking

Table 1.

	Aircraft, type	$n_e$ 1	$n_k$ daN/kg	$n_{kd}$ daN/kg	$V_{lad}$ km/h	$w$ m/s	$I_y$ 1	$P$ kg/m <sup>2</sup>
1	<b>F-4 Phantom</b>	7	0.52	0.84	280	152	1.44	382
2	<b>MiG-21 bis</b>	8	0.46	1.12	280	225	0.50	379
3	<b>MiG-29 (9.12)</b>	9	0.63	1.04	235	330	1.00	249
4	<b>F-16C</b>	9	0.62	1.07	235	300	0.61	270
5	<b>Su-22M4</b>	7	0.47	0.67	285	220	1.25	475
6	<b>F/A-18C</b>	8	0.58	0.94	240	300	1.04	258
7	<b>JAS 39</b>	9	0.68	1.01	235	300	0.37	200
8	<b>Su-27</b>	9	0.58	1.07	235	250	2.46	213
9	<b>MiG-29M</b>	9	0.59	1.02	235	334	1.08	270
10	<b>Mirage 2000-5</b>	9	0.59	0.90	220	284	0.51	217

List of abbreviations:

- $n_e$  – max service load;
- $n_k$  – normal thrust ratio (dry);
- $n_{kd}$  – max trust ratio (with afterburner);
- $V_{lad}$  – landing speed;
- $W$  – climbing speed;
- $I_y$  – inertial moment about the side axis to the moment of the MiG-29 9.12 variant;
- $P$  – surface load.

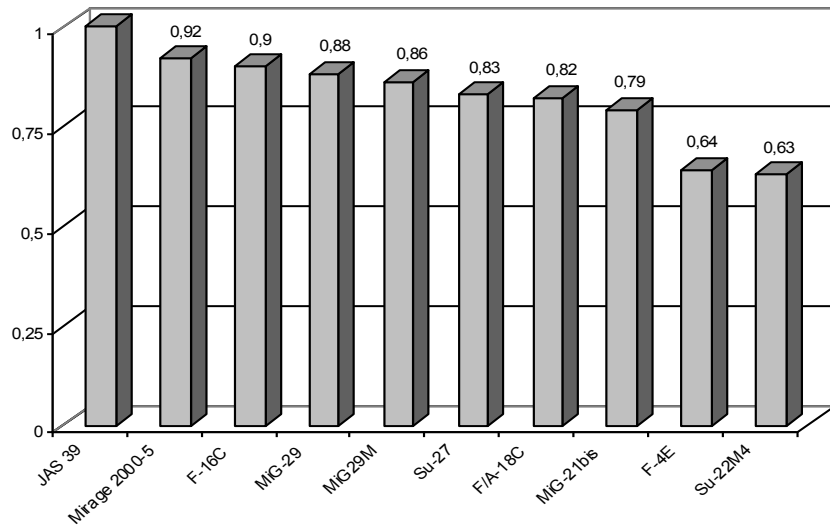

Fig.1. Manoeuvrability ranking

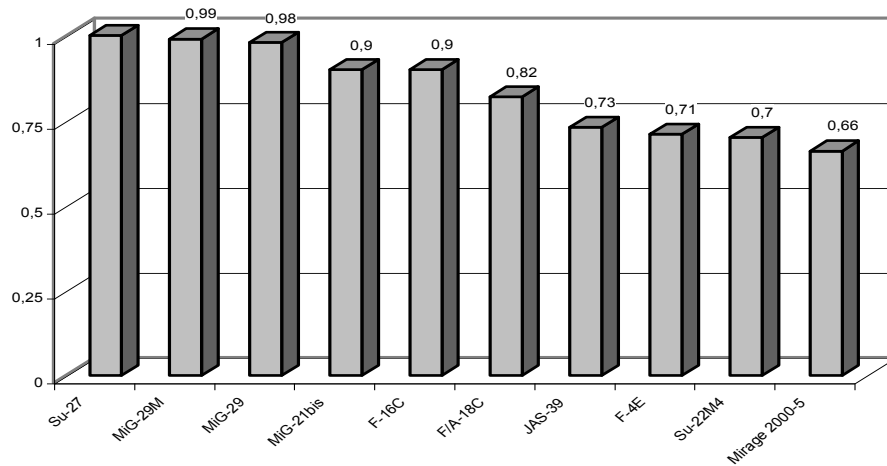

Fig. 2. Ranking of the dynamic properties

**REFERENCES**

- [1] Akao Y.: Quality Function Deployment: Integrating Customer Requirements into Product Design. Massachusetts 1990.
- [2] Reagan J.M., Downey F.M.: The TASCFORM Methodology a Technique for Assessing Comparative Force Modernisation. 6 edition, Arlington, USA, 1993.
- [3] Coniglio S.: Fighter-Bombers on Offer. Military Technology - MILTECH, 6, 1995.

- [4] Lorrey M., Raymer D.P., Kennedy M., Leveaux H.: The Grey Threat: Assessing for the next Generation of Aircraft. RAND Corporation, 11, 1995.
- [5] Błaszczyk J., Olejnik A., Zalewski P.: Analysis of the Technical Parameters and Performance of Modern Military Multi-role Aircraft. Third International Seminar on RRDPAE'98, Warsaw, 24-25.11.1998.
- [6] Błaszczyk J.: A new method of the aircraft evaluation by means of the matrix calculus. Fourth International Seminar on RRDPAE. Warsaw 30.11-2.12.2000.
- [7] Błaszczyk J., Wróblewski M., Zalewski P.: Fundamental problems of the weapon system evaluation an example of the expert assessing method of the aircraft effectiveness. III International conference on Armament, Waplewo, 11-13.10.2000.
- [8] Błaszczyk J., Wróblewski M., Zalewski P., Comparative assessment of the combat survivability of the contemporary military aircraft. III International conference on Armament, Waplewo 11-13.10.2000.





## AN ANALYSIS OF THE AXIAL FLOW COMPRESSOR STABILITY USING THE BIFURCATION THEORY

### INTRODUCTION

Axial flow compressors are designed to operate in steady axisymmetric flow. If the mass flow is decreased, the pressure rise increases but, unfortunately a critical value is reached, beyond steady flow is no longer stable; a small change in the flow may be enough to push one into the unstable region. It is important to know the nature of the flow that develops in this situation, as the different flows can have quite different consequences.

In this paper it will be shown how bifurcation theory can be used to characterise each type of flow and locate the regions of parameter space where such a flow is stable. The flow regimes are: axisymmetric steady, nonaxisymmetric steady, axisymmetric time dependent and non-axisymmetric time dependent and are known respectively as design flow, rotating stall, deep surge and classic surge.

It is possible to reduce the Moore-Greitzer model for compressor instability to a set of three ordinary differential equations using a one-mode truncation in bifurcation theory. The flow entering the inlet is uniform and the duct is straight (radial variations are negligible); the flow is assumed to be incompressible and irrotational (the velocity potential of any disturbance which develops in the inlet satisfies Laplace's equation). The unsteady flow is 2D in axial distance and circumferential angle and the general solution is:

$$\tilde{\phi} = \sum_{n=1}^{\infty} a_n(t) e^{in\theta} \left\{ e^{n(\eta+l_I)} + e^{-n(\eta+l_I)} \right\} + c.c. \quad (1)$$

where  $\tilde{\phi}$  is the potential function for the disturbance in the inlet. The independent variables are time (nondimensionalised with the time for the wheel to rotate one radian), angular position and axial distance (nondimensionalised with the wheel radius). The disturbance that reaches the compressor face is assumed to move straight through the compressor to the plenum and as a result the only independent variables are and time,  $t$ . The rate of change of mass flow through the compressor can be related to the pressure rise in the following way:

$$\frac{l_c}{S} \Phi'(t) = -\Psi(t) + \frac{1}{2\pi} \int_0^{2\pi} \Psi_c(\phi) d\phi \quad (2)$$

where  $\Phi$  represents the angle averaged axial mass flow and  $\Psi$  represents the angle averaged pressure rise, with the prime denoting differentiation with respect to  $t$ . The mass flow coefficient and pressure rise coefficient have been rescaled and shifted so that:

$$\Phi = \frac{\text{mass flow coefficient}}{W} - 1$$

$$\Psi = \frac{\text{pressure rise coefficient}}{H}.$$

Parameters  $W$  and  $H$  are scaling factors chosen so that the resulting performance curve is representative for all compressors at all speeds. Let  $P_{\max}$  be the maximum pressure rise coefficient and  $M_{\max}$  be the corresponding mass flow coefficient. Then:

$$W = \frac{M_{\max}}{2}$$

$$H = \frac{P_{\max} - \Psi_o}{2}.$$

The axial mass flow coefficient is:

$$\phi(\theta, t) = \Phi(t) + \tilde{\phi}_{,\eta|_{\eta=0}}$$

where  $\tilde{\phi}_{,\eta|_{\eta=0}}$  is the axial flow disturbance.

The function  $\Psi_c(\phi)$  in (2) represents the response of the compressor in steady axisymmetric flow; it is a typically S-shaped curve (Moore-Greitzer):

$$\Psi_c(\phi) = \Psi_{co} + 1 + \frac{3}{2}\phi - \frac{1}{2}\phi^3 \quad (3)$$

The parameter  $\Psi_{co}$  reflects the number of stages in compressor,  $l_c$  represents the inertial length of the compressor and the scaling parameter  $S=H/W$ .

When the angle variations are taken into account and the pressure rise is summed over each component of the engine, we arrive at the following expression which acts as the last boundary condition for Laplace's equation in the inlet:

$$\left[ m \tilde{\phi}_{,t} + \frac{1}{a} \tilde{\phi}_{,\eta t} \right]_{|\eta=0} = -l_c \Phi'(t) - S \Psi(t) + \Psi_c(\phi) - \frac{1}{2a} \tilde{\phi}_{,\eta\theta|_{\eta=0}} \quad (4)$$

where  $\tilde{\phi}_{,\eta|_{\eta=0}}$  is the axial mass flow disturbance at the compressor face. Parameter  $m$  reflects the type of exit duct ( $m=1$  for abrupt expansion;  $m=2$  for the long channel); parameter  $a$  is associated with the time lag of the flow in between the rows of blades.

Assuming the process in the plenum polytropic, the mass continuity equation for the plenum chamber is:

$$l_c \Psi'(t) = \frac{1}{(2B)^2 S} [\Phi(t) - \Phi_T(\Psi)], \quad (5)$$

where  $\Phi_T$  is the mass flow coefficient leaving the chamber. The pressure rise through the throttle is modelled by the simple parabolic relationship:

$$\Psi = \frac{1}{\gamma} (\Phi_T + 1)^2 \quad (6)$$

where  $\gamma$  is the control parameter for the exit mass flow.

To simplify the parameter groupings we define a new time variable:

$$\xi = t \frac{S}{l_c}$$

Substituting this into (1),(2),(4),(5) and recalling the solution for the inlet flow field gives the “full model”. The prime now denotes differentiation with respect to time.

$$\Phi'(\xi) = -\Psi(\xi) + \frac{1}{2\pi} \int_0^{2\pi} \Psi_c(\phi) d\theta \quad (7)$$

$$\Psi'(\xi) = \frac{1}{(2BS)^2} [\Phi(\xi) - \Phi_T(\Psi)] \quad (8)$$

$$\tilde{\phi} = \sum_{n=1}^{\infty} a_n(\xi) e^{in\theta} \left\{ e^{n(n+l_I)} + e^{-n(n+l_I)} \right\} + c.c. \quad (9)$$

$$\frac{1}{l_c} \left[ m \tilde{\phi}_{,\xi} + \frac{1}{a} \tilde{\phi}_{,\eta\xi} \right] \Big|_{\eta=0} = -\Phi'(\xi) - \Psi(\xi) + \Psi_c(\phi) - \frac{1}{2aS} \tilde{\phi}_{,\eta\theta} \Big|_{\eta=0} \quad (10)$$

## ONE MODE TRUNCATION

This simplification has been added advantage that eight parameters of the full model can now be reduced to four. It is assumed that the second and higher modes have negligible amplitude:

$$\tilde{\phi} = a_1(\xi) e^{in\theta} \left\{ e^{n(n+l_1)} + e^{-n(n+l_1)} \right\} + c.c. \quad (11)$$

Substituting into (10) gives:

$$\begin{aligned} & \frac{1}{l_c} \left[ m(e^{l_1} + e^{-l_1}) + \frac{1}{a}(e^{l_1} - e^{-l_1}) \right] a_1'(\xi) = \\ & = \left[ -\frac{i}{2aS} + \frac{3}{2}(1 - \Phi^2)(e^{l_1} - e^{-l_1}) \right] a_1 - \frac{3}{2}(e^{l_1} - e^{-l_1}) a_1^2 \bar{a}_1 \end{aligned}$$

The complex coefficient  $a_1$  can be written as:

$$a_1(\xi) = \frac{r(\xi)}{(e^{l_1} - e^{-l_1})} e^{i\delta\xi} \quad (12)$$

where  $r$  is the amplitude and  $\delta$  is the phase speed of an angular disturbance. Substituting this into the above and separating real and imaginary parts gives

$$\frac{r'(\xi)}{r} = \frac{\sigma}{2}(1 - \Phi^2 - r^2); \quad \delta = -\frac{\sigma}{6aS}$$

where:

$$\sigma = \frac{3l_c a (e^{l_1} - e^{-l_1})}{m a (e^{l_1} - e^{-l_1}) + (e^{l_1} - e^{-l_1})} \quad (13)$$

The equation for  $r$  can be further simplified by introducing  $R=r^2$ . Equation (8) is unchanged and the integral in (7) can be solved explicitly. Equations (7)-(11) are thus reduced to the following set of three ordinary differential equations:

$$\Phi'(\xi) = -\Psi + \Psi_c(\Phi) - 3\Phi R \quad (14)$$

$$\Psi'(\xi) = \frac{1}{\beta^2}(\Phi - \Phi_T(\Psi)) \quad (15)$$

$$R'(\xi) = \sigma R(1 - \Phi^2 - R) \quad (16)$$

where  $\beta=2BS$ . Both  $\Psi$  and  $R$  can assume only positive values; the former because of physical constraints and the latter because it is a squared quantity. Equations (14)-(16) contain the essential dynamics of the physical problem. Using the bifurcation theory to define the boundaries for different flow regimes in the  $(\beta, \gamma, \Psi_{co}, \sigma)$  parameter space is possible to determine the possible solutions of this set of ordinary differential equations before solving them numerically.

The problem of locating the stationary points of (8)-(10) and examining their stability can be expressed as  $\dot{x} = F(\mu, x)$  where  $x \in \mathfrak{R}^3$ ,  $\mu \in \mathfrak{R}^4$

The stationary values  $x_0 = \{x_{0i}\}$  satisfy  $F(\mu, x_{0i}) = 0$  and the stability of each  $x_{0i}$  is governed by the eigenvalues of the linear operator  $L_\mu = D_x F(\mu, x_{0i})$ . When no eigenvalue has a positive real part, the stationary point is stable to small perturbations; if one of this has real part positive, then the equilibrium point is unstable. As the parameter  $\mu$  is varied, qualitative changes may occur in the dynamics. These changes are called bifurcations and the parameter values are called bifurcations values. We first find the simplest bifurcations of the equilibria and latter discuss the bifurcations of the periodic orbits. A qualitative picture where the branches of the equilibria are shown in  $(x, \mu)$  space is a bifurcation diagram. A bifurcation set consists of the loci of the bifurcation points in  $\mu$  space. An examination of (14)-(16) shows that there are two equilibrium values of  $R$ ,

$$\begin{aligned} R &= 0 \\ R &= 1 - \Phi^2 \end{aligned}$$

The first of these demands  $\Psi = \Psi_c$ , which defines the axisymmetric characteristic. For the second case

$$\Psi = \Psi_{co} + 1 - \frac{3}{2}\phi + \frac{5}{2}\phi^3 \quad (17)$$

which defines the rotating stall characteristic. Linearising (14)-(16) about an equilibrium point  $(\Phi_e, \Psi_e, R_e)$  gives:

$$\Phi'(\xi) = (\Psi'_c(\Phi_e) - 3R_e)\Phi - \Psi - 3\Phi_e R$$

$$\Psi'(\xi) = \beta^{-2}\Phi - \beta^{-2}\Phi'_T(\Psi_e)\Psi$$

$$R'(\xi) = -2\sigma\Phi_e R_e \Phi + \sigma(1 - \Phi_e^2 - 2R_e)R$$

The plane defined by  $R=0$  is invariant since all flows starting on this plane will remain there forever. For all parameter values there is a fixed point  $x_{01}$  on this plane at the intersection of the curves  $\Psi_c(\Phi)$  and  $\Psi(\Phi_T)$ . Trajectories with  $R=0$  represent axisymmetric flow and when fixed point is stable, it represents the steady design flow. At large values of  $\gamma$  the design flow represented by  $x_{01}$  is stable. Decreasing  $\gamma$  corresponds to reducing the mass flow and causes  $x_{01}$  to

lose stability either at a transcritical or a pitchfork bifurcation point. We denote this bifurcation point as  $\gamma_c$ . At this stage we restrict our attention to the fixed points which are of interest physically, i.e., those which lie on or above the  $R=0$  plane. With  $\Psi_{co} < 4$ , two new fixed points,  $x_{02}$  and  $x_{03}$ , results from the saddle node bifurcation at  $\gamma = \gamma_s$ . The latter is unstable (having a complex pair of eigenvalues and a positive real eingevalue) until it moves below the  $R=0$  plane at the transcritical bifurcation where  $x_{01}$  loses stability. Thereafter it is no longer of physical interest. The stability of  $x_{02}$  will be discussed momentarily. In the critical case,  $\Psi_{co} = 4$ , where  $x_{01}$  loses stability at a pitcfork bifurcation point. In this case  $x_{03}$  exists only for  $R < 0$  and hence has no physical meaning. For  $\Psi_{co} > 4$  the saddle node bifurcation lies below the  $R=0$  plane and  $x_{01}$  now loses its stability at the transcritical bifurcation point with  $x_{02}$  and  $\gamma = \gamma_c$ . When  $x_{01}$  is stable, it represents the steady axisymmetric flow which is the design condition of the engine, and when  $x_{02}$  is stable the flow condition modeled is steady rotating stall. The only occasions when  $x_{03}$  is stable occur in the physically meaningless negative half/space of R. The positions of the equilibrium points vary with  $\gamma$ , and the loci of the fixed points on the graph of pressure rise versus mass flow are called characteristics. The axisymmetric points lie on the cubic  $\Psi_{co}(\Phi)$  axisymmetric characteristics). The non axisymmetric fixed points lie on another cubic, the rotating stall characteristic.

## CONCLUSIONS

The three ordinary differential equations were studied using the methods of bifurcation theory, which gave the boundaries in space parameter for each type of solution. The analysis shows the qualitative difference between deep surge (a purely axisymetric periodic orbit with actual trajectories showing some rotating stall initiated by the back ground distortion) and classic surge (associated with the Hopf bifurcation of the rotating stall point). The bifurcation analysis is of great value in the study of compressor instability. It provides a complete picture of the parametric effects in this simple model.

### REFERENCES

- [1] BOSCOIANU Mircea, ZAGANESCU Florin, An Analysis of Rotating Stall in Multistage Axial Compressors, 22nd International Congress of Aeonautical Sciences ICAS 2000.

## ISSUES ABOUT AIRCRAFT TURBOJET ENGINES CONTROL LAWS

### INTRODUCTION

The mathematical pattern that describes the functioning of the parts of a turbojet engine, from the thermogasodynamic point of view, is represented by a system of equations at which the number of the unknown parts are bigger than the number of the equations. So, solving the system of equations without imposed additional terms is not possible. The additional conditions imposed to the parameters of the engine at the changing of the flight conditions are called control laws, and the ones imposed to the parameters of the engine at the changing of the functioning regimes (for the same flight conditions) are called control programmes. Choosing a certain control law or program represents a very important issue, with implications on the height and speed characteristics. In order to analyse the laws and control programmes of the turbojet engines, it is necessary to find the functioning equation of the set compressor – combustion chamber – turbine.

From the equation of mass flow, written for the section of entrance into the turbine, results:

$$\begin{aligned} & \sqrt{\frac{k}{R} \left( \frac{2}{k+1} \right)^{\frac{k+1}{k-1}}} \cdot S_1 \cdot q(\lambda_1) \cdot \frac{P_1^*}{\sqrt{T_1^*}} (1 + q_c) \cdot (1 - \delta_1) = \\ & = \sqrt{\frac{k'}{R'} \left( \frac{2}{k'+1} \right)^{\frac{k'+1}{k'-1}}} \cdot S_3 \cdot q(\lambda_3) \cdot \frac{P_3^*}{\sqrt{T_3^*}} \end{aligned} \quad (1)$$

where:

k – the adiabatic exponent;

R – the air constant parameter;

$\delta_1 = \frac{G_{ar}}{G_a}$ ;  $G_{ar}$  is the air flow that comes from the compressor for the set

climatisation – pressurisation and cooling of the turbine blades, and  $G_a$  is the air flow of the engine;



$q_c = \frac{G_c}{G_a}$  where  $G_c$  is the fuel flow introduced in the combustion chamber;

$M$ ,  $p$ ,  $T$  — represent the Mach number, the pressure and the temperature;  
The indices “1” si “3” refer to the entrance section in the compressor and the turbine;

$$q(\lambda_1) = \lambda_1 \cdot \left[ 1 - \frac{k-1}{k+1} \lambda_1^2 \right]^{\frac{1}{k-1}} \cdot \left( \frac{k+1}{2} \right)^{\frac{1}{k-1}}; \quad \lambda_1^2 = \frac{\frac{k-1}{2} M_1^2}{1 + \frac{k-1}{2} M_1^2};$$

Considering that  $p_3^* / p_1^* = \pi_c^* \cdot \Gamma_{ca}$ , the equation above can be expressed like this:

$$\pi_c^* = q(\lambda_1) \sqrt{\frac{T_3^* \cdot T_0}{T_1^*}} \cdot C_1 \cdot \frac{S_1}{S_3} \quad (2)$$

where  $T_0 = 288^\circ K$ , and  $C_1$  is a constant.

If the surfaces  $S_1$  (compressor inlet) and  $S_3$  (turbine inlet) are constant, then the equation becomes

$$\pi_c^* = q(\lambda_1) \sqrt{T_{3r}^*} \cdot C_2 \quad (3)$$

The equation (3) represents in co-ordinates  $(\pi_c^*, q(\lambda_1))$  a line with the slope  $\sqrt{T_{3r}^*} \cdot C_2$ .

The constant  $C_2$  is determined by knowing the thermogasodynamic parameters at the calculation regime.

On the other hand, from the equality of the compressor power and of the turbine  $N_c = N_t \cdot \eta_m$ , results:

$$\left( \pi_c^{*\frac{k-1}{k}} - 1 \right) \frac{1}{\eta_c^*} = T_{3r}^* \left( 1 - \frac{1}{\pi_t^{*\frac{k-1}{k}}} \right) \cdot \text{const.} \quad (5)$$

Replacing the parameter  $T_{3r}^*$  from the equations (3) and (5) we obtain the functioning equation of the set compressor – combustion chamber - turbine:

$$\frac{q(\lambda_1)^2 \left( \pi_c^{*\frac{k-1}{k}} - 1 \right)}{\pi_c^{*2} \left( 1 - \frac{1}{\pi_t^{*\frac{k'-1}{k'}}} \right) \cdot \eta_c^*} = C_3 \quad (6)$$

This equation can be modified by replacing the turbine pressure ratio,  $\pi_t^*$ , obtained from the equation of the mass flow, written for the inlet section in the stator of the first turbine step and the critical section of the jet nozzle,  $S_{5cr}$ :

Considering

$$\pi_t^* = p_3^* / p_4^* \text{ si } T_4^* = \left[ 1 - \left( 1 - \frac{1}{\pi_t^{*\frac{k'-1}{k'}}} \right) \cdot \eta_t^* \right] \quad (8)$$

results

$$\pi_t^* \sqrt{1 - \left( 1 - \frac{1}{\pi_t^{*\frac{k'-1}{k'}}} \right) \cdot \eta_t^*} = [S_{5cr} \cdot q(\lambda_{5cr}) / S_3] \cdot \text{const.} \quad (9)$$

From the equation above the turbine pressure ratio  $\pi_t^*$  (that depends on  $S_{5cr}$ ,  $S_3$  and  $q(\lambda_{5cr})$ ) is obtained. If the engine has the sections  $S_{5cr}$  and  $S_3$  invariable and it works at a supracritical regime ( $p_4^* / p_H > \beta_{cr}$ ), then  $q(\lambda_{5cr}) = 1$  and so  $\pi_t^*$  is constant.

## CONTROL LAWS

*Control law  $n = \text{const.}$*

For a turbojet engine with  $S_3$  (the exit section from the stator of the first turbine step) and  $S_{5cr}$  (the critical exit section of the engine) constant, after the control law  $n = \text{const.}$ , the control factor consists of the fuel flow  $G_c = \text{var.}$  The automatic control system of the engine ensures the modification of the fuel flow so that at the modification of the inlet parameters in the engine (that is

accomplished by the modification of the flight conditions  $V_H$  and  $H$ ) to ensure continuously the condition  $n = \text{const.}$  In this way it is obvious that the following conditions should be obeyed:

$$T_3^* \leq T_{3 \max}^* \text{ \& i } \Delta K_y \geq \Delta K_{y \min}$$

where

$$K_y = \frac{[\pi_c^* / q(\lambda_1)]_{\text{line pomp.}}}{[\pi_c^* / q(\lambda_1)]_{\text{line funct.}}}, \text{ and } \Delta K_y = (K_y - 1) \cdot 100 \%$$

In order to determine the engine parameters, under the conditions of the control rule that is given, as an independent variable can be considered: the equivalent rotation  $n_r = n \sqrt{T_o / T_1^*}$ , the equivalent relative rotation  $\bar{n}_r = \bar{n} \sqrt{T_o / T_1^*}$ , or the temperature factor  $\sqrt{T_o / T_1^*}$ , where  $T_o = 288^\circ \text{K}$ ,  $\bar{n} = n / n_0$ ,  $n_0$  = the maximal rotation of the engine in the conditions  $M_H = 0$  and  $H = 0$ .

The independent variable is linked to the flight regime by the temperature  $T_1^*$  which is defined by the equation

$$T_1^* = T_H \left( 1 + \frac{k-1}{2} M_H^2 \right) \quad (10)$$

For  $H = \text{const.}$  (namely  $T_H = \text{const.}$ ) along with the growing of  $M_H$  the  $T_1^*$  grows, too, and so  $\bar{n}_r$  decreases and for  $M_H = \text{const.}$ , with the growing of  $H$  until 11 km,  $T_1^*$  decreases because of the decreasing of the temperature  $T_H$  and, so, the  $\bar{n}_r$  grows.

*Control law*  $T_3^* = \text{const.}$

Maintaining a temperature  $T_3^*$  constant, in front of the turbine of an engine with the geometry of the flow sections, invariable, in the conditions of the modification of the flight regime, it can be achieved by the modification of the fuel flow, so that  $T_3^* / T_4^* = \text{const.}$  In this way, the engine rotation will modify because of the temperature  $T_1^*$  at the compressor inlet. The line of functioning regimes for a turbojet with uncontrolled sections are traced with the help of equation (6), so for the two control laws ( $n = \text{const.}$  and  $T_3^* = \text{const.}$ ) the position of this line in the characteristic of the compressor is the same, but for the same value of  $\bar{n}_r$ , correspond different values of the engine rotation.

For this control rule, the conditions  $n \leq n_{\max}$  și  $\Delta K_y \geq \Delta K_{y \min}$  must be achieved.

*Control law  $n_r = \text{const}$ .*

By this control rule, the automatic control system modifies the fuel flow, at the modification of the flight conditions, depending on  $T_1^*$ , so that the rotation may be proportional with the modification of the parameter  $\sqrt{T_o / T_1^*}$ , because  $n_r = n \sqrt{T_o / T_1^*}$ .

The limitations imposed in this case will be:  $n \leq n_{\max}$  and  $T_3^* \leq T_{3 \max}^*$ .

The line of the functioning regimes, which verifies the equation (6) from the compressor characteristic goes to a single point, which corresponds to the design regime, so for all the flight regimes, the values of the parameters  $\pi_c^*$ ,  $q(\lambda_1)$ , and  $\Delta K_y$  will be constant and equal with the values from the design regime.

So, through the design point in the compressor characteristic only a line will cross, corresponding to  $T_{3r}^* = \text{const}$ .

Obviously, the control of the engines can be done after one or more parameters. To obtain better characteristics, the combined control rules are used, namely certain control laws for certain flight regimes.

In Fig.1 is shown the variation of  $\bar{n}$ ,  $n_r$  și  $T_3^*$  depending on  $\sqrt{T_o / T_1^*}$  for a combined control law. For such a combined control rule, the temperature  $T_{11}^*$  from which we pass to a new control law, is chosen to ensure the imposed parameters of the engine at all flight regimes, obeying the limitative conditions:  $n \leq n_{\max}$ ,  $T_3^* \leq T_{3 \max}^*$  and  $\Delta K_y \geq \Delta K_{y \min}$ .

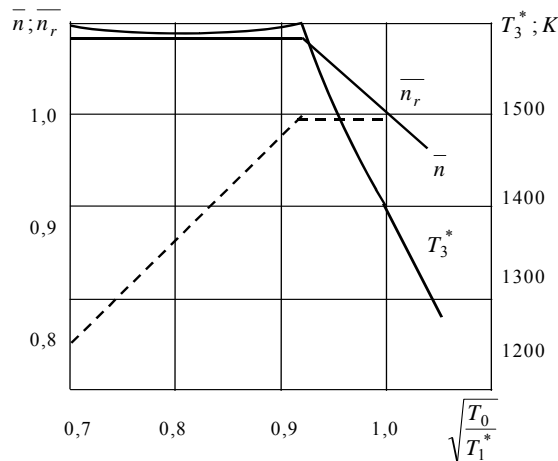

Fig. 1

In Fig. 2 an example of combined control law like  $n = \text{const.}$ ,  $T_3^* = \text{const.}$ ;  
 $\bar{n}_r = \text{const.}$ ,  $T_3^* = \text{const.}$  is presented.

This control law is possible at the engines with the critical section area of the nozzle  $S_{scr.}$ , variable.

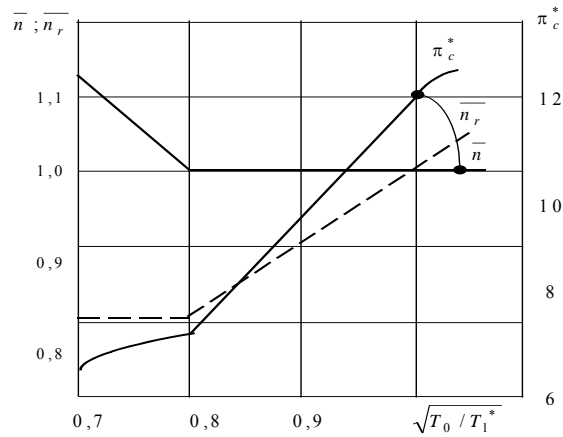

Fig.2

## CONCLUDING REMARKS

The equation (6) allows the plot of the line of the functioning regimes of the engine in coordinates  $(\pi_c^*, q(\lambda_1))$  depending on the law or control program. We see a very big influence on the position of the line of the functioning regimes has a surface of the section of exit from the combustion chamber and turbine entrance. The difficulty of achieving such a variable section is obvious in this area of the engine because of the very high temperature of the combustion gas. Another conclusion drawn from this is that of the possibility of improving the performance of turbofan with a mixture of the two flows after the turbine by modification of this section.

## REFERENCES

- [1] STANCIU Virgil, *Characteristics of turbojet engines*, "Pitaco Trade Company" Publishing House Bucharest, 1993.
- [2] ROTARU Constantin, *Theory of Turbojet Engines*, Publishing House of Military Technical Academy, Bucharest, 1999.
- [3] STOICESCU Mihai, ROTARU Constantin, *Turbojet Engines. Characteristics and Control Methods*, Publishing House of Military Technical Academy, Bucharest, 1999.

## **DATA LINK CONCEPTION FOR JOINT TACTICAL UNMANNED AERIAL VEHICLES BASED ON STDMA PROTOCOL**

### **INTRODUCTION**

Any information about theater of operations has the strategic sense. Acquisition of that information by using Joint tactical unmanned aerial vehicles has become common in few last years. In this paper, I present the basic approaches of modern data link conception for unmanned aerial vehicles (UAV) operating in environment causing a lot of errors and interference.

Effective utilization of UAV needs reliable and precise control of that vehicle and design of dependable crash-proof secure data links between UAV and control station (CS). Communication system must ensure transmissions of TV signal, and telemetric information from onboard sensors to control station and command control from CS to UAV. Generally, there are two separate data links with different data transfer rate.

If several UAVs operate together and one of them works as relay station, the conception of the data links is getting more complicated and it must fit following requirements:

- Basic of the system is multiple access protocol.
- Entire data throughput of the system allows transmission of image signal from at least three sources simultaneously.
- Each UAV is able to transmit and receive data containers of equal size (relay function).
- All UAVs are completely replaceable by each other.

Satisfaction of all above-defined requirements is not elementary. The most important parameter of the system is data throughput in arbitrary spatial configuration of the system.

### **RECEIVER AND TRANSMITTER FUNCTIONS**

Modern sophisticated radio communication devices are designed with respecting to software oriented radio conception with an open architecture and modular

components, which has a lot of advantages. One of the motivating factors behind developing them is that they have the potential to provide enhanced performance, growth and flexibility. Figure 1 illustrates the functional diagram and the basic elements of a spread spectrum digital communication system, with which we can mainly meet in data link conceptions.

The functions of the particular elements will be discussed in next chapters. Discussion will be limited only on the transmitter functions because of the receiver functions are generally inverse.

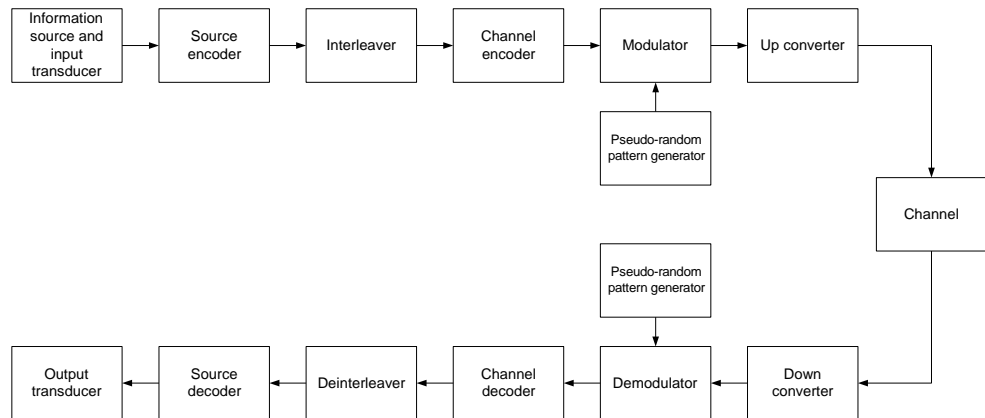

Fig. 1: Basic elements of a spread spectrum digital communication system

### Source coding

Because command control and information messages don't have high redundancy, we don't have to use source coding and therefore this chapter will describe source coding of image information.

Image modulation signals of analog TV systems share wide frequency band, approximately from 4 to 6MHz. After conversion, the bit rate of a PCM formatted digital signal is higher than  $200\text{Mb}\cdot\text{s}^{-1}$  and the bit rate of HDTV systems is even higher. If the system cannot supply such a high bit rate, it's necessary to implement an effective source coding in a transmitter.

Digital communication systems for transmissions of video signals, whose have suppressed the redundancy, mustn't have the bit error rate (BER) worse than  $10^{-10}$ . Generally, there are two types of the redundancy in TV signals: spatial and time redundancy.

Only modern video source encoders based on the MPEG-2 standard can sufficiently suppress bit rate from  $200\text{Mb.s}^{-1}$  to  $5\text{-}10\text{Mb.s}^{-1}$ .

### **Channel coding and interleaving**

If a system cannot ensure a required BER by using optimal methods of modulation and detection of the signal we have to use channel codes that make it possible to achieve reliable communication, with as small an error probability as desired. The channel capacity requirements will rise by using the channel coding. In particular, we treat two classes of codes, namely, block codes and convolutional codes. The block codes are widely used in wireless applications, because they are simply feasible, sufficiently effective and can be used for high bit rates. The Reed-Solomon code seems to be suitable for data link concept, because it is much faster than convolutional code.

Most of the well-known codes that have been devised for increasing the reliability in the transmission of the information are effective when the errors caused by the channel are statistically independent. This is the case of AVGN channel. However, there are channels that exhibit bursty error characteristic. An effective method for dealing with burst error channels is to interleave the coded data in such a way that the bursty channel is transformed into a channel having independent errors. The interleaver can take one of two forms: a block structure or a convolutional structure. A block interleaver formats the encoded data in a rectangular array of  $m$  rows and  $n$  columns. The bits are read out column-wise and transmitted over the channel. Convolutional interleavers are better matched for use with the class of convolutional codes.

Unfortunately, the complicated digital communication systems cannot achieve reliable communication with a simple channel coding. Therefore they use concatenated codes and the forward error correction (FEC).

### **Spread spectrum and digital modulator**

The concept of data link using the spread spectrum (SS) with applied method of direct sequence (DS-SS) is the most perspective for the military applications. The advantage of DS method of spreading the frequency spectrum is that the unauthorized receiving of the transmitted signal is disallowed or at least embarrassed. Next benefit of the DS concept is his reliability during the operating in the environment with a lot of errors and interference due to jamming, multipath propagation and noise. The basic of the robustness of this method is caused by spectral expansion of the spurious signal in input



demodulator in contrast to desired signal. Only fractional part of the spurious signal energy appears on the output of following narrow band filter.

The input data are spreaded by pseudorandom sequence with several times higher bit rate than is the bit rate of original input data. Spreading is accomplished by logical XOR. Output data flow is at the next time processed by digital modulator.

Current systems of data transmission most of the time use the methods of quadrature phase shift keying (QPSK) and its varieties. They are the most effective under the condition of jamming.

The offset QPSK (O-QPSK) modulation, instate of classical QPSK is widely used in data link concepts due to its less spurious amplitude modulation.

### **Up convertor**

Up-convertor converts modulation signal and interfrequency (IF) into required frequency band, which is wide enough to realize reliable transmission of signal with high bit rate. The transmission of image information is accomplished in the X or Ku bands.

### **Methods of encryption**

According to the text above the SS transmission concept contains certain degree of encryption itself, which is defined and characterized by used algorithm of pseudorandom sequence generation. The principal of frequency spectrum expansion also hides the present of signal behind noise. When higher demands of the encryption are requested, there can be added an encryptor into the communication system. In the military applications are common the standard encryptors COMSEC devices KG-68 and KG-135.

## **PROPOSAL OF THE DATA LINK BASED ON STDMA PROTOCOL**

The STDMA protokol can be charakerized like a TDMA protocol with the dynamic slot allocation. A unique feature of the STDMA system is the way that the available transmission time is divided into a large number of short time-slots synchronized to a global time base. Each time slot may be used by a radio transponder (mounted on aircraft, ground vehicles or at fixed ground stations) for transmission of data. The exact timing of the slots and planned use of them

for transmissions are known to all users, so that efficient use of the data link can be made and users do not transmit simultaneously. As a result of this ‘self-organizing’ protocol, the STDMA system does not require any ground infrastructure to operate and can therefore support air-air as well as ground-air communications and applications.

## Communication system architecture

Each user of the system is equipped (UAV, surface station) with a transponder for determining the position and time, managing transmissions on the data link and for transmitting and receiving data. Figure 2 shows one of the principle architecture of a communication system. This principle architecture is the same for airborne and ground users.

The GNSS receiver provides position and time information via its one pulse per second time signal. This pulse is synchronized to UTC. The communication processor co-ordinates the use of the communication channel and holds a virtual image of the time-slot frame in its memory. Further, it controls the slot allocation for the station own transmissions and continuously updates its own slot map.

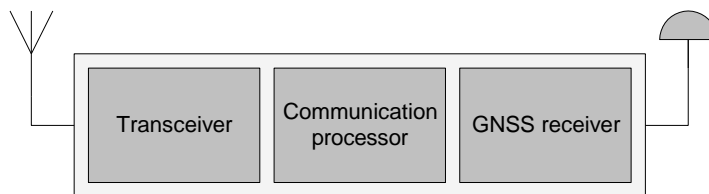

Fig. 2. Communication system architecture

The communication processor controls the transceiver functions. The internal structure of the transceiver was discussed in chapters above.

## Slot selection

An important feature of the STDMA protocol is the method used to select the slots for a new transmission or for placing reservation for future transmission. When a channel is not busy, slot selection is straightforward since a slot that has not been previously reserved by another station can be easily found. When a channel becomes busier such that unreserved slots are harder to find, the system must ensure slot selection according to the priority of transmitted data. For example the transmission of the command control has higher priority than the transmission of the ISR sensor data. The slot selection process is described in next bullets:

- An application wishing to send data or to place a reservation to send data in the future first specifies a range of candidate slots from which a slot will be chosen.
- The station then derives a list of available slots. The available slots are a subset of the candidate slots
- A slot is selected randomly from the available slots.

### **Channel capacity**

In a TDMA system, each user transmits for  $1/K$  of the time through the channel of bandwidth  $W$ , with average power  $KP$ . Therefore, the capacity per user is

$$C_K = \left(\frac{1}{K}\right)W \log_2 \left(1 + \frac{KP}{WN_0}\right)$$

The channel capacity per user in STDMA system will be changing according to slot allocation requests. It means that there will not be requested extremely high channel capacity for transmission of control signals – only small number of allocated slots. On the other hand the image transmission requires incomparable higher number of allocated slots caused by desired bit rate about 20 MB.s<sup>-1</sup>. The average channel capacity per user is then lower compared to protocol TDMA.

## **CONCLUSION**

As mentioned above, the data link transmissions among several users based on STDMA protocol achieve much better results than standard TDMA protocol. The main advantage is that surface control infrastructure is not required. Its self-organizing feature is divided from the synchronization by UTC time of GNSS receiver. Slot allocation seems to be complicated but the benefit is reduction of entire channel capacity.

## THE SAAB NETDEFENSE CONCEPT

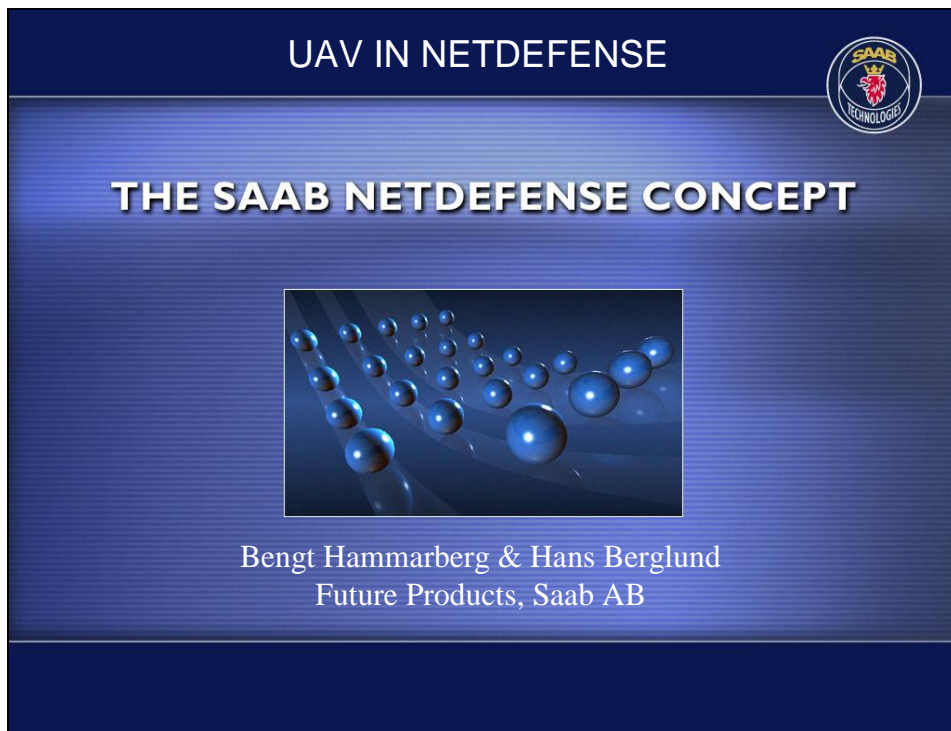

The Swedish armed forces will be drastically re-organized within the coming decade according to a government bill accepted by the Swedish parliament 1999. The emphasis will be put on what is called Net Centric Warfare, NCW, to certain extent at the expense of the traditional armed forces. Instead the system will allow them operate in more efficient way than before. This process has already started.

It should be mentioned that the ideas behind this change came from the US but there is probably no country where the plans have proceeded further than in Sweden.

The presentation represents Saab's view on NCW which we call the Saab NetDefense Concept, in particular with respect to the role of Unmanned Aerial Vehicles, UAVs.



The NET-Centric System constitutes a common net in which Army, Navy and Air Force units, Command Centers etc. are tied together. The user will have the possibility to have access to all relevant information, depending on the user's role. Actually the infrastructure of the existing Internet will be used, and a virtual net created with secure access control.



Decision Superiority will be obtained from quick from quick access to data gathered from different sensors which can be airborne, e g by UAVs, or on ground, on ships or in the sea. Also open information e g from the ordinary Internet will be used. The data will processed, compiled and presented in a way that simplifies the decision tasks.

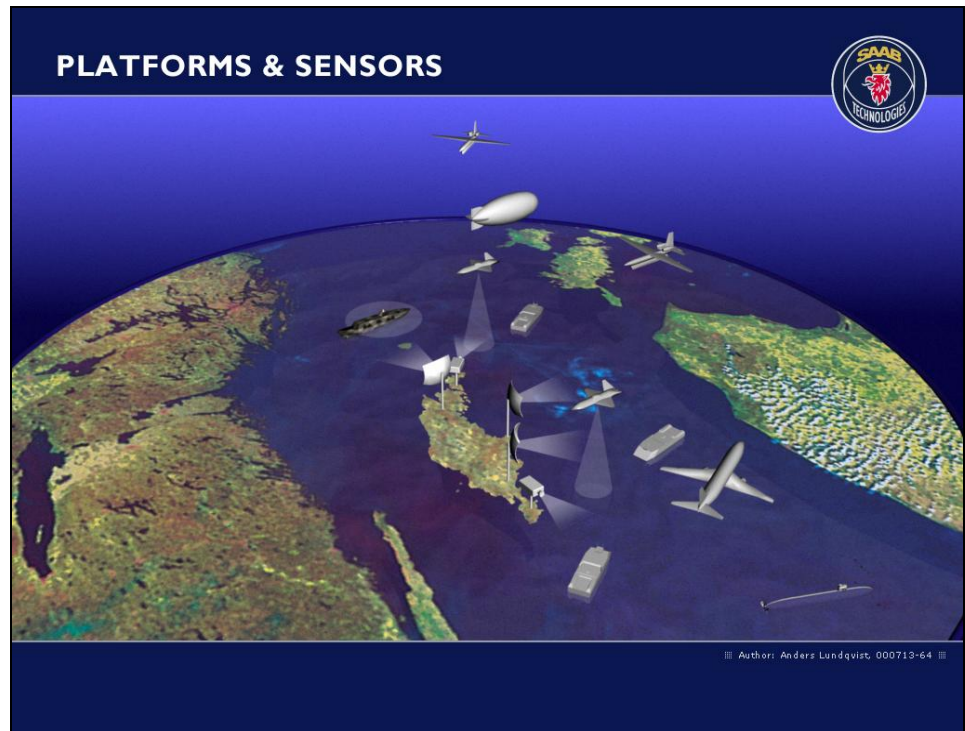

This picture illustrates different sensors and sensor platforms that can be used for surveillance over sea, in this case the Baltic.

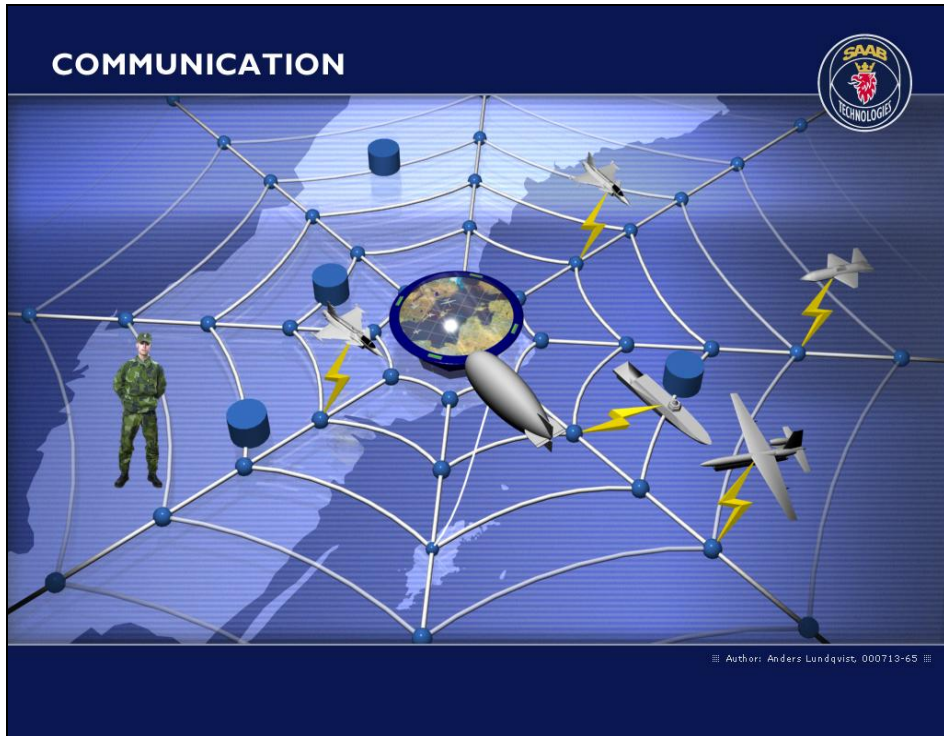

The different sensors or sources of information are connected to the net.



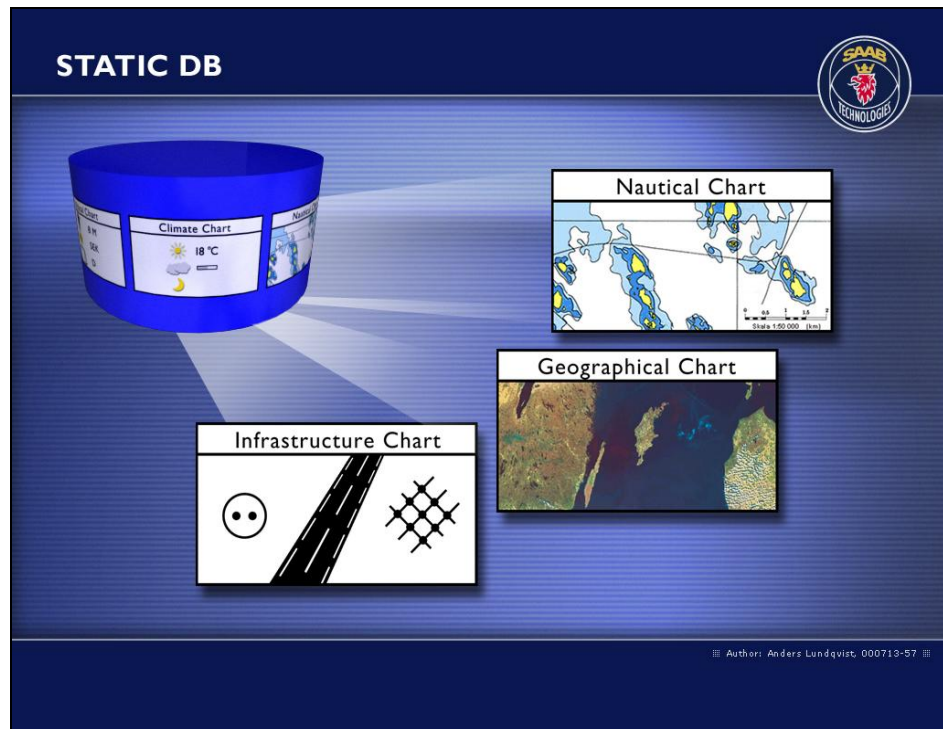

A number of data bases will be available in the system.  
There will be data bases with more or less static data e g geographical and nautical charts and infrastructure charts.

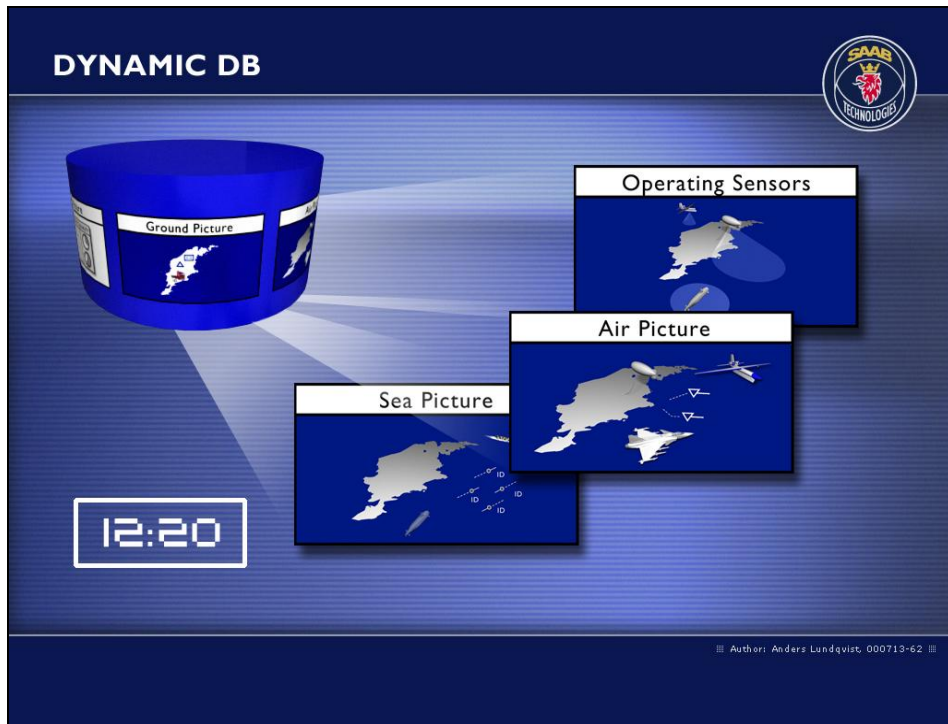

Dynamic data bases which will be created and continuously updated, containing data about available sensor platforms, sensors, sensor data etc

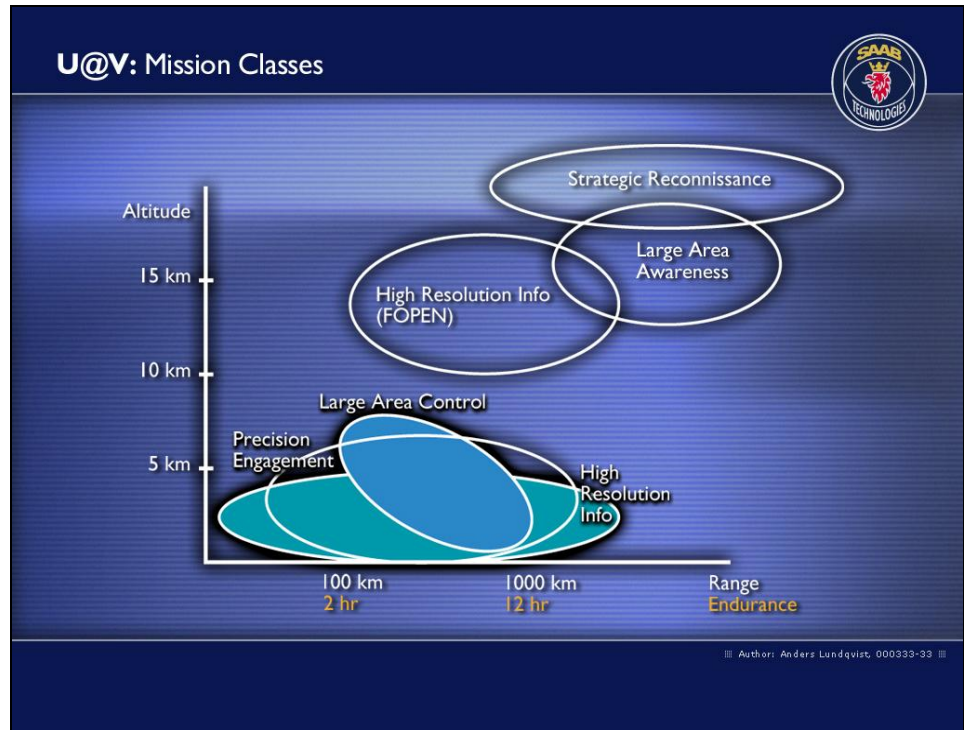

There are a great number of different tasks where UAVs could be useful, and also preferred compared to manned aircraft. The different tasks will require rather different UAV designs and different sensor equipment, Electronic Warfare (EW) equipment and weapon loads.

For Strategic Reconnaissance long range and endurance on high altitude is required. (Typical example: Global Hawk)

Large Area Awareness can be achieved on somewhat lower altitude.

High resolution radar reconnaissance with Foliage Penetration (FOPEN) can also be performed from high altitude and great distance.

Other sensors like EO/IR are normally operated at lower altitude to achieve high resolution.

Precision engagement with ground attack weapons is performed from low altitude.

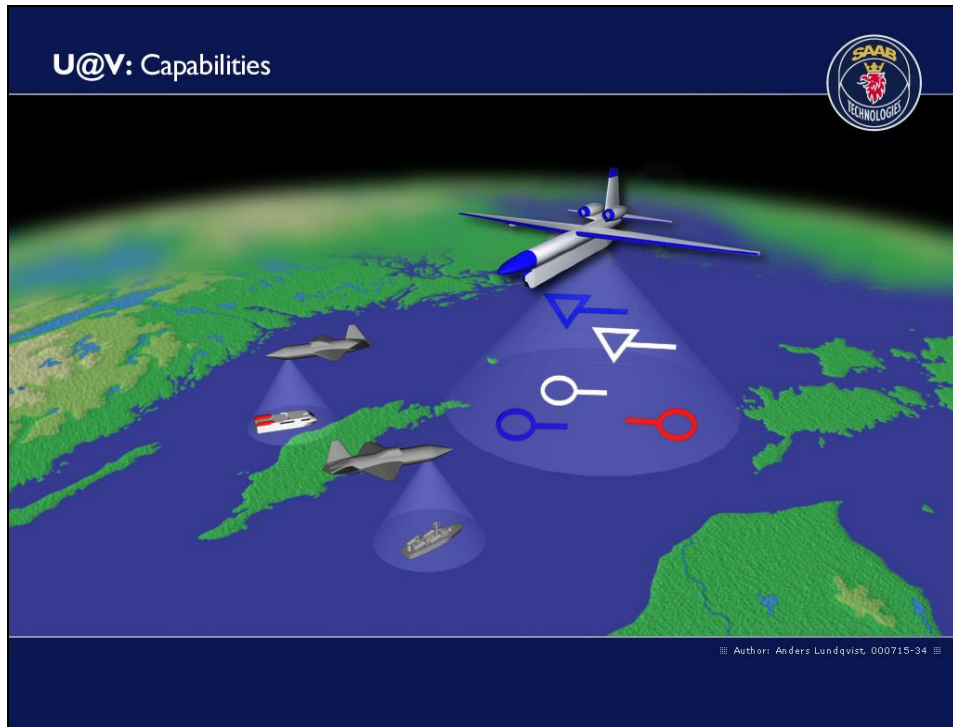

This is an example where potential intruders have been detected by a HALE, and quick reaction UAVs with high resolution sensors have been sent out to identify two ships on the sea (one ferry out of schedule, one military vessel). The symbols below the HALE represent known, unknown and hostile ships.

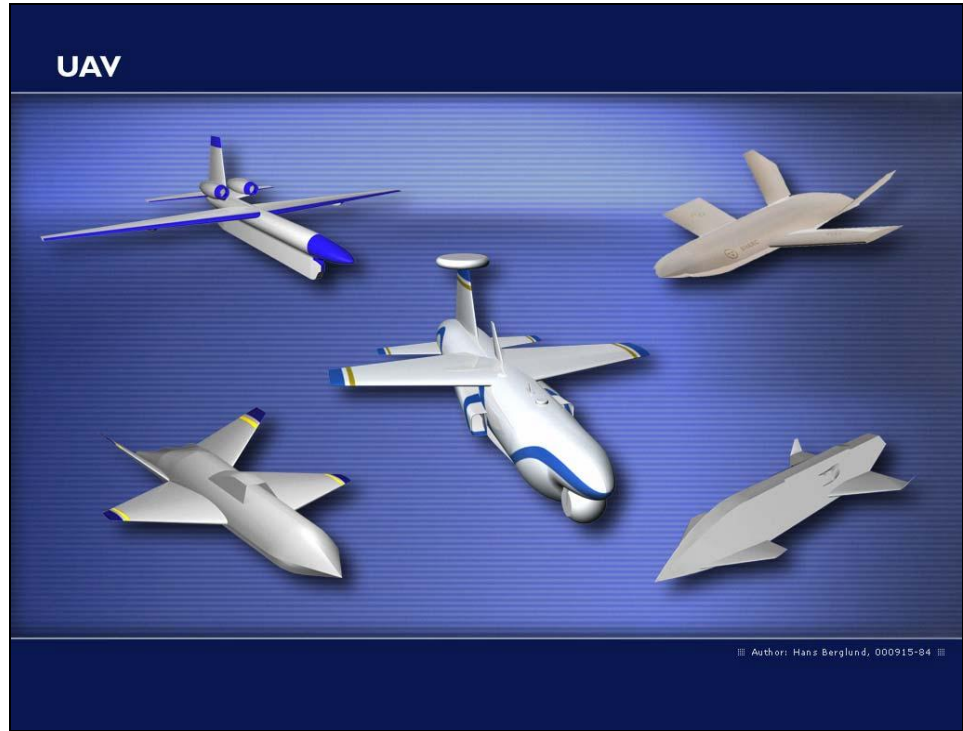

- Saab has performed a number of conceptual studies on UAVs for different tasks.
- a HALE for Large Area or Strategic Reconnaissance;
  - a medium altitude UAV for Ground Surveillance and quick reaction Precision Reconnaissance;
  - an UAV with similar tasks as the former one but with less performance;
  - a small medium altitude reconnaissance vehicle with limited range It is to be carried eg by a Gripen a/c and released not too far from the area of interest. Recovery by parachute;
  - anUCAV with precision weapons for ground attack.

Note that the scale in the picture is not consistent!

The vehicles are jet driven, and have Lo Observable features, with exception for the HALE and the (low cost) Reconnaissance vehicle in the center.

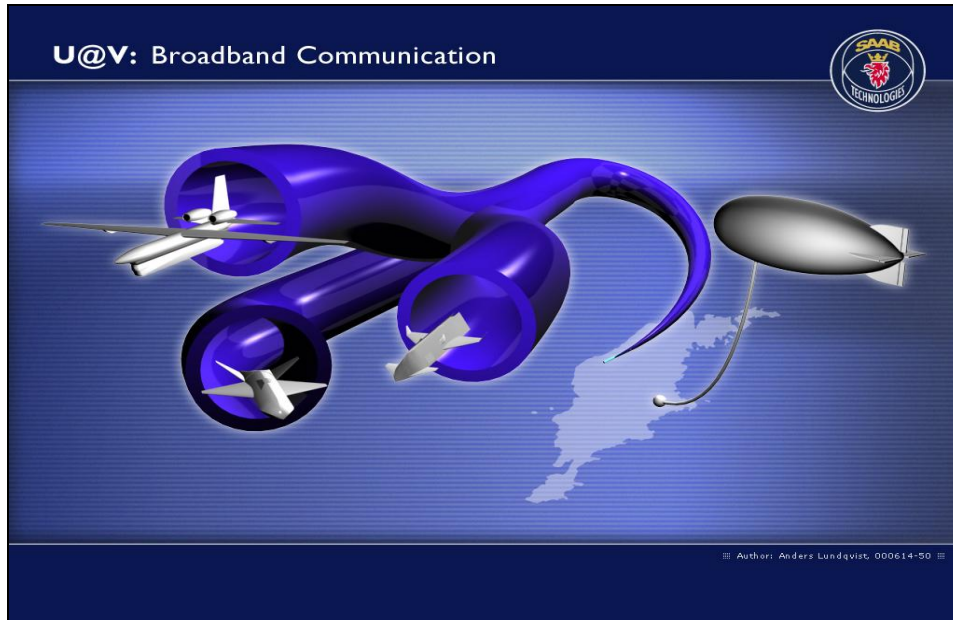

To be of any use the sensor data usually have to be transferred to ground, and when possible this should be done without any substantial delay. Normally a wide band point-to-point data link is required, but still there are physical limitations regarding the possible data rate. Typical factors are:

- antenna size;
- weather;
- line-of-sight conditions; affected by UAV height, ground/relay station height, and terrain masks;
- ground reflections;
- Lo-Observable requirements.

For these reasons the UAV will have on-board:

- High capacity data recording equipment for re-playing of data later during the mission and/or on ground;
- data processing capabilities for data reduction.

Satellite communication will be a solution to some of the problems, however.







The other task category is to control the sensors and other payloads (ref SENSOR OPS). We envision that these tasks may be transferred to an authorized commanding officer connected anywhere in the net. To a limited degree he may also control the flight path, especially in the target area. For flying in civil airspace in peace time all regulatory operational requirements have to be fulfilled which seems difficult, to do without additional aids and personell, normally available in a control station.



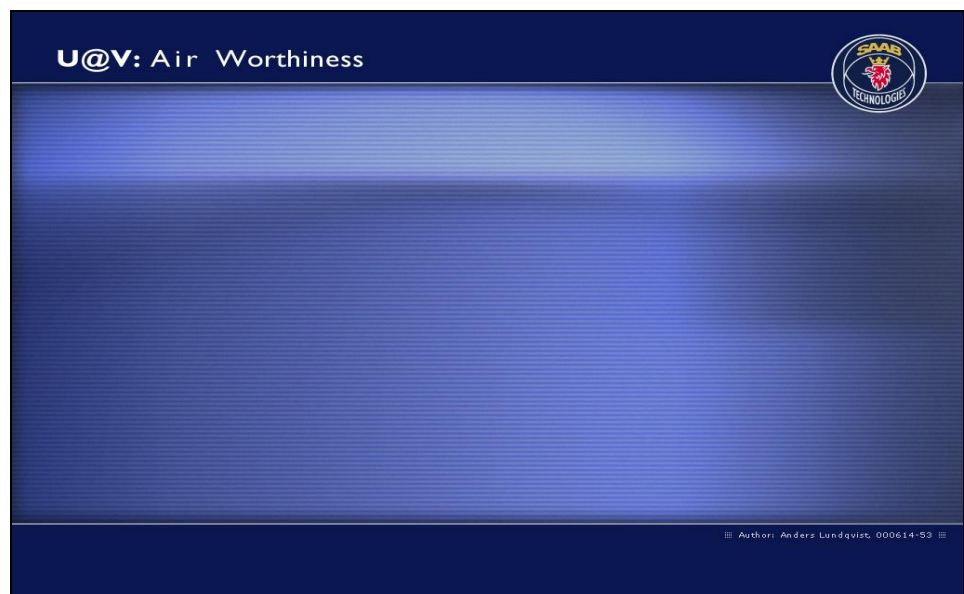

There are presently no generally agreed airworthiness regulations and operational rules for unrestricted UAV flight outside closed military areas. This situation we feel is quite unacceptable. However, the situation is not quite as dim as this picture, and we have at least a feeling for what the requirements will be.



- Probability for an „uncontrolled“ crash in the order of  $10^{-5}$  per Fh, similar to the total rate for manned military a/c today.
- Probability for an air collision – lower than for manned a/c today.
- Applicable parts of e g FAR/JAR 23 could be used as certification basis

Author: Anders Lundqvist, 000614-53

In Sweden a dialogue has started between the civil and military regulatory agencies, and with the industry, while waiting for international rules. Certain key probability figures have to be defined:

- probability for an „uncontrolled“ crash we think should be in the order of  $1 \cdot 10^{-5}$  per Fh which is similar to the total rate for manned military a/c today;
- probability for an air collision – lower than for manned a/c today.

Applicable parts of e g FAR/JAR 23 or could be used as a certification base  
To fulfill those requirements will require high integrity/redundant systems for flight control, navigation including flight planning, command data links, and functions for autonomous flight. To minimize the risk for air collisions an Automatic Air Collision Avoidance (Auto ACAS) system seems necessary, especially for VFR flight.

Saab is actively working on those issues, and other UAV issues, and we think we can offer solutions. We are also working together with other European nations e g within the so called ETAP program to develop technologies critical for UAVs.



As a summary we are confident that SAAB will be able to deliver the UAVs needed for the future Net Centered Warfare system.

## UNMANNED AIR VEHICLES — CRITICAL TARGETS

### INTRODUCTION

Unmanned Air Vehicles (UAV) are used in the time being as mainly reconnaissance means, but means more safe from point of view of their safety during their missions. Especially due to the fact that at the UAV board are needed instruments and devices only.

Regarding the different UAV utilisation in current military practice can be pointed out the following [1]:

- UAV during its flight collects a broad spectrum of reconnaissance or intelligence information's together with observation of large territories where can be expected serious targets;
- UAV can collect of combat action results;
- UAV regarding their board equipment can carry out optical, thermo vision observation, and recognition of electromagnetic waves spectrum as well as are able to observe the electronic warfare character;
- UAV can contribute to distinguish so-called “stealthy” operations, especially in very pure visibility conditions.

It is evident from the mentioned that UAV represent very serious threat regarding collection of information's being translated to ground centres in real time. More over there exists the possibility of UAV return to the ground base.

The UAV presence in the armies' armament represents very danger target from point of view of Air Defence (AD) tasks. Graphically it can be illustrated by figure 1.

Figure 1. introduces different targets regarding the possibility of their detection and destruction [1]. Further on is evident that UAV really represents one of targets type, which can't be simply detected and at the same time its destruction seems to be easily destructed. From point of view of AD task and jeopardy belong UAV to targets being very near to Tactical Ballistic Rockets (TBR) and Tactical Air to Surface Missiles (TASM) as targets which can be destroyed by different AD means (see figure 2).

*Legend:*

- CMs — Cruise Missiles;
- BR — Ballistic Rockets.

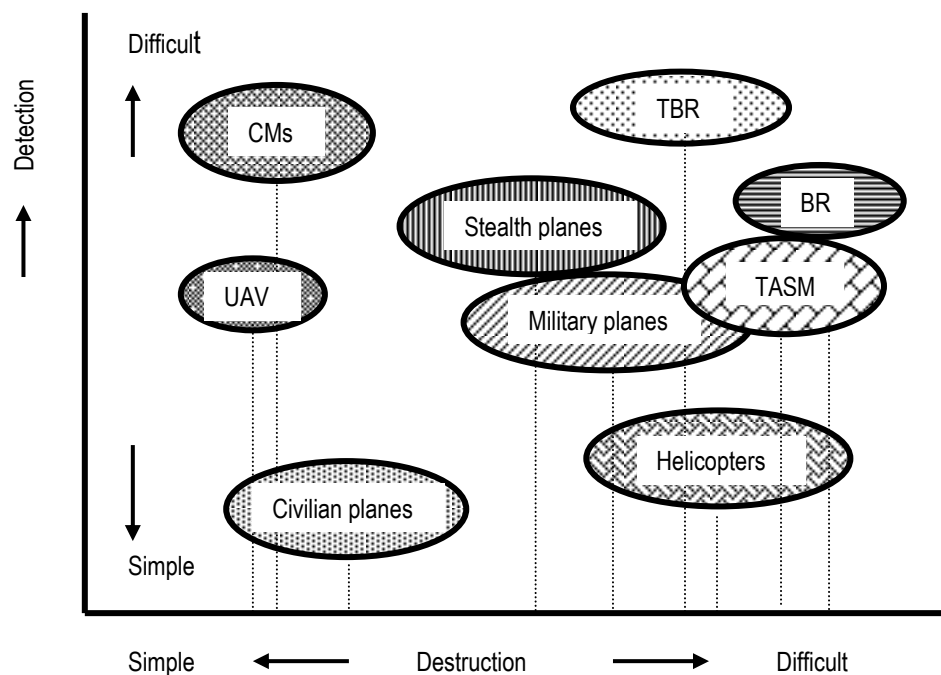

Fig. 1. Dependence „Detection – Destruction“ for different targets

## MAIN PROPERTY OF UNMANNED AIR VEHICLES

UAV as means of which utilises mainly aerodynamic forces for its mission fulfilment (UAV trajectory – different from ballistic one) is as a rule guided either by the help of autonomous board control system or remotely. UAV is able to carry effective payload, which doesn't causes the target damage or payload determined for target destruction. According military authorities can be assumed utilisation of UAV of the *Air – to – Air* type or as UAV of *Air – to Ground* type. Such determination of UAV arises from future reasons to apply UAV as real combat means the cost of such mean is less when fielded into the army armament (this fact is interesting for those countries having smaller Defence Ministry budget) [2].

Countries having at disposal modern Aircraft technology are able to design and produce UAV means. More over many of military authorities are of opinion that UAV compared with classical Air forces means (i.e. winged aircrafts and helicopters) represent future main Air forces means. Such conclusion results from the analyses of this problem, i.e.:

- UAV doesn't need high cost for preparation of flying personal;

- Convenient ground simulators can secure preparation of ground operators, which secure conditions being very near to the real ones, or are identical to real ones.

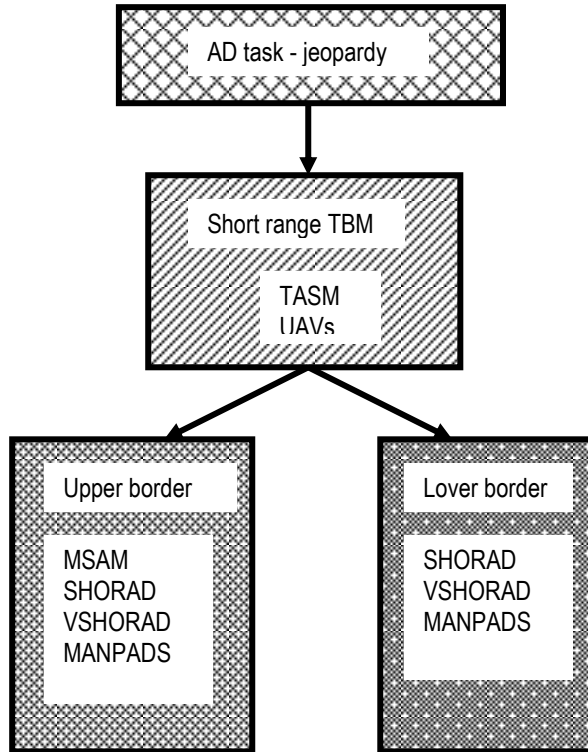

Fig. 2. Air Defence Systems being able to act against danger targets

*Legend:*

- MSAM — Medium Surface to Air Missiles;
- SHORAD — Short Range Air Defence;
- VSHORAD — Very Short Range Air Defence;
- MANPADS — Man Portable Air Defence.

As mentioned before the planning of operations takes into consideration to use UAV in combat missions. In such case the UAV is also called as Combat Unmanned Air Vehicle (CUAV). Using CUAV the number of aircraft flight missions can be reduced from 55% to 85% and costs of manned missions being compared with CUAV are approximately comparable.

The advantages of UAV (CUAV) can be introduced as follows [2]:

- Price of UAV will be less because there is no need equipment of pilot cockpit space (e.g. no need of pilot ejecting seat, climatisation etc.);
- Range and time of flight are as a rule bigger (due to smaller aerodynamic resistance of UAV, doesn't exist limitations regarding presence of flying personal and their fatigue);
- Bigger utilisation of UAV due to smaller reflection area, relatively smaller over all dimensions, higher manoeuvre ability, smaller overloading;
- Reduction of crew for ground UAV control and guidance and further personal;
- Smaller crew number and smaller auxiliary equipment (there is no need of take-off and landing runways as well as air force bases).

Beside the mentioned advantages exist also some disadvantages regarding UAV, i.e.:

- Communication with UAV board can accidentally be lost due to enemy electronic actions as well as common jamming and limited number of frequencies;
- Outer effect influencing the work of operator (e.g. due to the flight control actions, action of enemy aircrafts, fire of Air Defence systems, especially barrel means, infrared systems of air defence rockets etc.);
- Smaller possibility of quick and correct elimination of faults acting on UAV, there doesn't exist the possibility to remove the failure, incorrect function of board systems and subsystems during UAV flight, difficulties in case of accident landing on spare landing base and deficiency of fuel;
- Military types of UAV exist practically in two categories, i.e. [2, 3]:
  - Flying targets (for preparation of AD troops);
  - Reconnaissance means.

The prospective category of UAV will be soon the category of combat UAV (CUAV). Principle tactical and technical data of known UAV categories are introduced in table 1 and table 2 [2].

Tab. 1

Category	Flight duration (h)	Tactical UAV	
		Ceiling (m)	Range of flight (km)
Micro ( $\mu$ )	1	250	< 10
Mini	< 2	250	< 10
Close Range (CR)	2 ÷ 4	3000	10 ÷ 30
Medium Range (MR)	1	3000 ÷ 5000	> 250
Low Altitude and Deep Endurance (LADP)	1	9000	> 250
Long Range (LR)	6 ÷ 13	5000	> 500
Long Endurance (LE)	12 ÷ 14	8000	> 500

UAV (CUAV) characteristics introduced in tables 1 and 2 are deduced from respective construction arrangement and equipment of auxiliary ground elements of UAV (CUAV) [2, 3].

Mission of UAV (CUAV) is as a rule determined by character of effective payload, i.e. respective sensors and armament at the board. Sensors at the UAV board can vary regarding the UAV mission and task type.

Tab. 2

Category	Flight duration (h)	Strategic UAV	
		Ceiling (m)	Range of flight (km)
Medium Altitude and Long Endurance (MALE)	24 ÷ 48	8000	> 500
High Altitude and Long Endurance (HALE)	12 ÷ 14	20 000	> 1000

Conception of UAV (CUAV) can schematically be illustrated by figure 3.

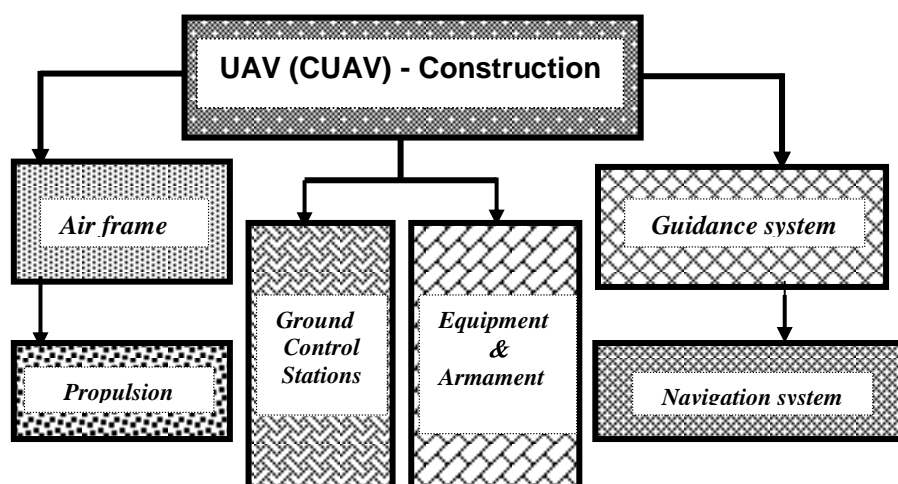

Fig. 3. Conception of UAV (CUAV) Construction

Possible reconnaissance and tracking tasks as well as electronic combat actions usually are of need of infrared, or opt electronic sensors and further on laser markers etc. According to available information were carried out successful experiments with weapon systems at the UAV board, e.g. Mk 82 bombs or guided missiles “Maverick”.

In conclusion can be stated that UAV (CUAV) systems eliminate the human being from the UAV flight process.



## CONCLUDING REMARKS

It is evident from above mentioned that unmanned systems represent qualitatively new systems being able to fulfil different combat tasks. Therefore such category of armament regarding the future combat missions seems to be as very important from point of view of “*reconnaissance*” and “*combat*” tasks.

Beside the problems related to UAV (UCAV) should also be solved problems related to the questions of effective defence against them.

Respective solution of effective defence against such targets type should follow the individual defence system task. There exist a variety of possible manner allowing covering of target type as well as the type of threatening are the properties, which should be fulfilled by effective defence system. Therefore can be applied different AD systems, but every one would have specified task.

Reduction of Defence Ministry budgets beside sophisticated technologies together with political pressure results in the following:

- Development of unmanned means starts to have high priority;
- Exists a broad scientific and military teams working in the scientific and development sphere.

The introduced notes represent main but important problems related to UAV (UCAV) problems. From the introduced is therefore clear that the future weapons and armament systems.

Beside the UAV (UCAV) design problems would be solved the problems related to the AD and its effectiveness. Mainly for that, that such sophisticated weapon systems represent high threat regarding the defended combat structure and territory.

### REFERENCES

- [1] LUDVÍK, F.: Review of Unmanned Air Vehicles in Military Armament. In. Journal of 9<sup>th</sup> European Air Defence Symposium, RMCS, Shrivenham, United Kingdom, 2001.
- [2] LUDVÍK, F. — MÁJEK, V. — KONEČNÝ, P. — ŠIMÁČEK, M.: „CÍLE“ (Scientific and Development Report), MA in Brno, 2001.
- [3] KOZAKIEWICZ, A. — ZALEVSKI, P.: State of the Art and Military Application of Unmanned Aerial Vehicles. In. Journal of 3<sup>rd</sup> International Armament Conference, Waplewo, Poland, 2000.

## FUZZY CONTROL OF THE ANTILOCK BRAKING SYSTEM OF THE PLANE'S LANDING GEAR

The present ABS controller of the braking system of the MiG21 aircraft induces high stresses of its components due to the bang-bang type controller. Thus, a smoother controller should be used to protect both the mechanical components and the braking system itself. A suitable controller was considered to be the Fuzzy Controller, based on the Mamdani approach.

### BRAKING PHENOMENON BASICS

Fig. 1 depicts a wheel during the braking process. The notations used in the picture have the following assignments:

- $T_{br}$  – applied braking torque;
- $L_w$  – wheel load;
- $Z_w$  – ground's vertical reaction;
- $X_w$  – ground's horizontal reaction (due to the applied braking torque);
- $\omega_w$  – wheel's angular speed;
- $v$  – vehicle's speed;
- $r_w$  – dynamic tire radius;
- $T_{rol}$  – viscous friction torque (insignificant);
- $I_w \frac{d\omega_w}{dt}$  – wheel's inertia moment [1, 2].

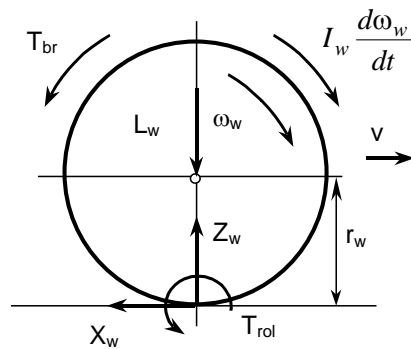

Fig. 1 Wheel during braking

According to this figure, the motion equation can be written after dividing it with  $L_w r_w$ , like:

$$\frac{I_w}{r_w Z_w} \frac{d\omega_w}{dt} - \frac{T_{br}}{r_w Z_w} + \mu_x \quad (1)$$

where, as above mentioned, the viscous friction torque was neglected. As known, the braking process can't be approached without taking into consideration the grip (adherence) between the wheel and the road's surface. This is expressed by the dependence of the grip coefficient on the axial direction  $\mu_x$  on the wheel relative slip on the road's surface given by:

$$s = \frac{v - \omega_w r_w}{v} \cdot 100 [\%] \quad (2)$$

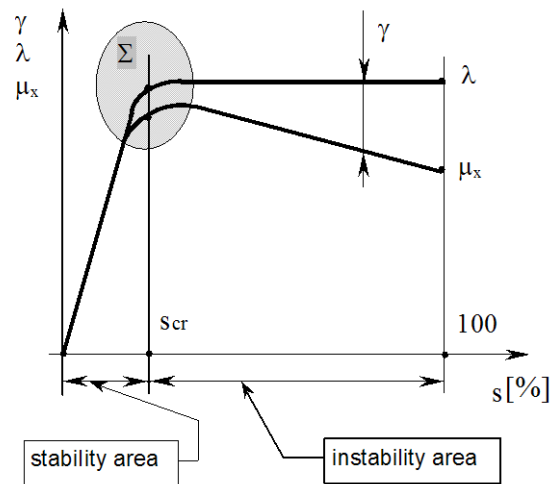

Fig. 2 Variation of the specific coefficients versus slip, during ABS assisted braking

The curve is plotted experimentally and has the shape given by fig. 2, different qualitative shapes needing experimental research.

If rewrite the equation (1) using the definitions:  $\frac{I_w}{r_w Z_w} \frac{d\omega_w}{dt} = \gamma$  and

$\frac{T_{br}}{r_w Z_w} = \lambda$ , one could get [1]:

$$\gamma - \lambda + \mu_x = 0 \quad (3)$$

The evolution of these three terms versus slip is depicted in fig. 3. As seen here, optimal brake appears if the applied braking torque keeps his value within the shadowed area.

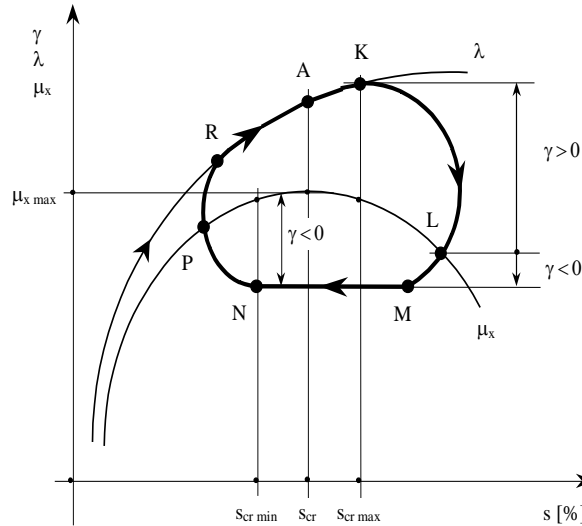

Fig. 3 The variation of  $\gamma$ ,  $\lambda$  and  $\mu_x$  versus slip during ABS assisted braking process

## THE BEHAVIOR OF THE ABS BRAKED WHEEL

The ABS braking principle is easily understood concerning the  $\Sigma$  area depicted in fig. 2. In this area, the  $\lambda$  coefficient (braking moment dependant) leaves the common curve which it previously made with the road grip  $\mu_x$  showing the fact that the applied braking torque is kept at his maximum value, or at a value which leads inevitable to the wheel's lock. Thus, fig. 3 that represents a magnified picture of the specified area, marks a critical slip  $s_{cr}$ , which is usually implemented into the ABS logic.

The tuning parameter of the braking process when ABS used is given by the wheel deceleration (particularly by the  $\gamma$  coefficient of the main equation), but taking into account the preset acceptable slip (usually about 20%).

Fig. 4 depicts the shapes of the time-dependant braking characteristic curves when braking with or without ABS. The higher the working frequency of the ABS, the smaller the steps of the "stair" and hence, the shorter the braking time and space, for a given road surface (grip).

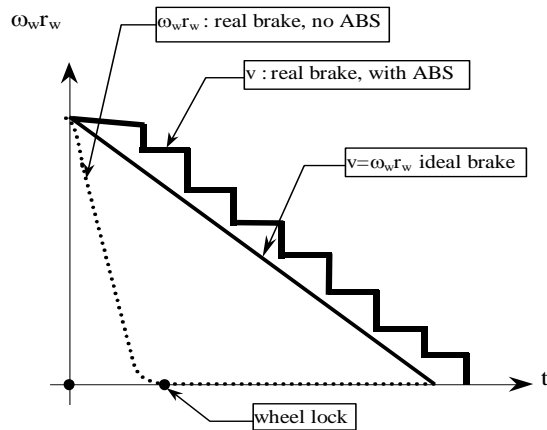

Fig. 4 The shapes of the characteristic curves during braking with and without ABS

## SIMULATION RESULTS

In this chapter a comparison between the present and the proposed control systems will be taken into account. That will allow a better balance between the system's actual behavior and the expected fuzzy controlled one, underlining both the advantages and the disadvantages of these two different approaches [2, 4].

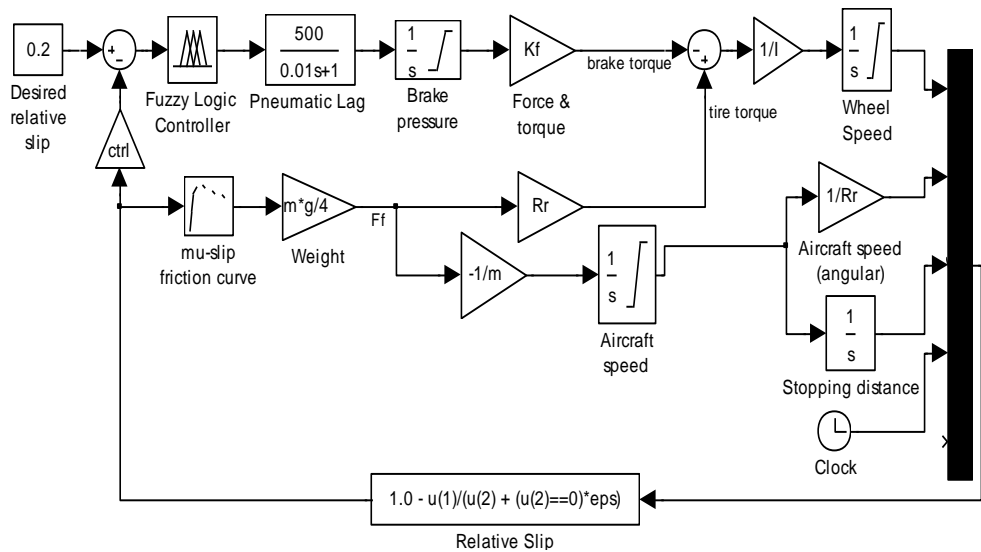

Fig. 5 The Simulink diagram, the ABS braking model

According to the present system's configuration, we considered that the proper model would be the one featured by a bang-bang relay, which was only supposed to replace the fuzzy controller pictured in fig. 5.

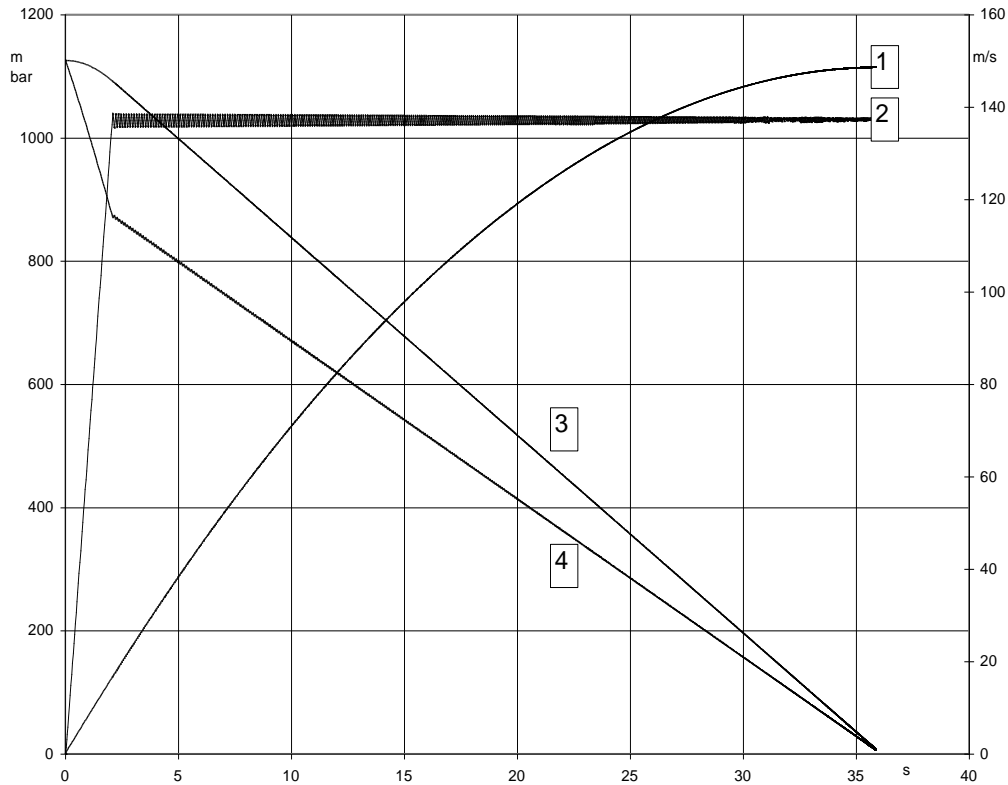

Fig. 6 The variation of the main braking parameters while using the present controller

The MiG 21 aircraft features were taken into account when simulating the braking process both with the bang-bang controller and the fuzzy logic controller. The landing mass was 6000 kg, the chosen landing speed was 200 km/h, the wheel radius was 0.4 m and the landing runway was chosen as dry asphalt, with a 0.7 maximum grip coefficient. All the data needed to feature the pneumatic and the mechanical components the system were achieved experimentally by the aircraft specialists.

Fig. 6 depicts the behavior of the main braking parameters when using the present controller working on the plane's landing gear [3].

If replacing the bang-bang controller with a Mamdani Fuzzy Logic controller [4] one gets the behavior depicted in fig. 7. As seen in this picture, the pressure

variation is fine smoothed, thus the mechanical and pneumatic stresses of the braking components are significantly decreased. The applied rule base furnished the following input and output membership functions, given in the fig. 8 and 9.

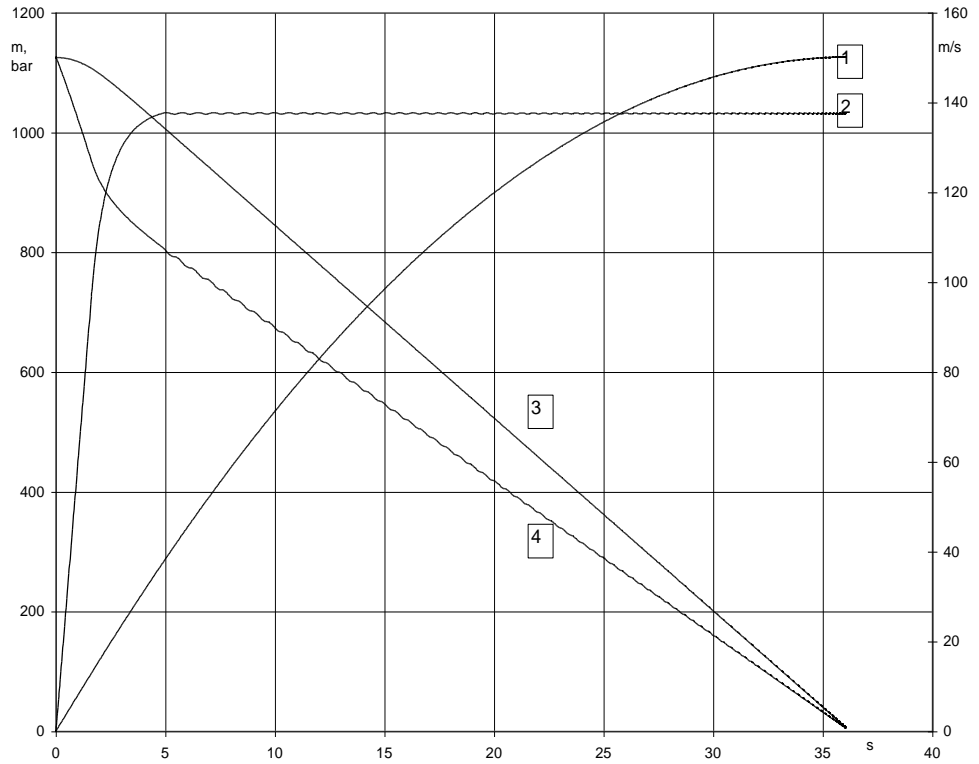

Fig. 7 The variation of the main braking parameters while using a Mamdani Fuzzy Logic controller

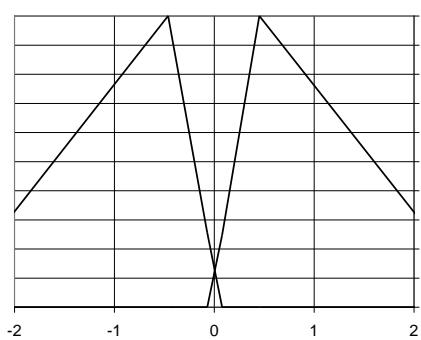

Fig.8 Input membership functions

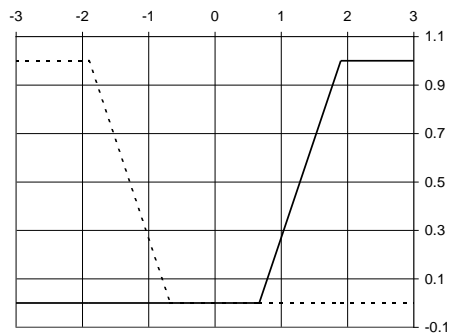

Fig. 9 Output membership functions

A very important feature that should be balanced was the space used by the aircraft until it's final stop. As a matter of fact, a smoother behavior of the applied pressure, hence, of the applied braking torque, will inevitably lead to an increased stopping distance. But as the simulation results revealed, the stopping distance isn't too much bigger when using the Fuzzy Logic controller instead of the bang/bang controller. Thus, the stopping distance according to the present system is of 1110 m, while the stopping distance when using the Fuzzy Logic controller is of 1130 m. The difference means about 2%, that assumes an affordable value.

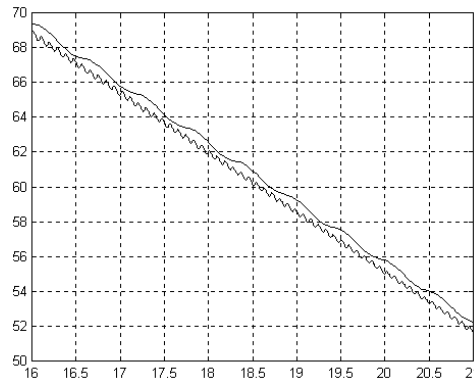

Fig. 10. Comparison between the wheel's angular speed fluctuation for the bang-bang controller (down) and the FL controller (up)

A better comparison between these two types of controllers can be seen in fig. 10, where the wheel's angular speed fluctuation versus time have been zoomed for a certain period of braking time, both for the actual bang-bang controller and the fuzzy logic controller. As noticed, the bang-bang controller's angular speed fluctuation is beneath the fuzzy logic one, so the actual controller is more effective than the proposed one, resulting in a shorter stopping distance, but on the other hand the actuating system is subjected to a much harder, periodical oscillation.

## CONCLUSIONS

The fuzzy logic controller leads to a slight increase of the stopping distance, but the benefits brought to the mechanical and pneumatic equipment of the landing gear's braking system are significant. Further simulation using different fuzzy logic rule bases have been developed but no significant improvements have been achieved. Even the pressure curve kept on smoothening, the stopping distance increased significantly, so they have been aborted.



#### REFERENCES

- [1] FRATILA Gh, MARCULESCU Gh.: Sistemele de finare ale autovehiculelor. Ed. Didaactica si Pedagogica, Bucuresti, 1986.
- [2] DOBRESU Radu: Autovehicule inteligente. Ed. Matrix Rom, Bucuresti, 1995.
- [3] \* \* \* - MiG 21 Techincal Book. 3<sup>rd</sup> volume, Bucuresti, 1970.
- [4] KEIN Ralf and others: ABS and vechicle speed estimation using Fuzzy Logic. 1<sup>st</sup> Embedded Computing Conference, October 1996, Paris, vol.3 pp 662-668.

## **ALGORITHM COMPUTING ELECTROMAGNETIC WAVE SCATTERING FROM ROUGH SURFACES**

### **INTRODUCTION**

Mostly, when one is talking about rough surfaces and wave scattering from rough surfaces there is assumed random rough surfaces. Practically it means that we deal with the surface that actual geometrical shape is not defined. Instead of exact forms and scattering properties the average approach to real scattering pattern is considered.

D. E. Barrick defines three basic kinds of problems in his part of RCS handbook, ref. [3], dedicated to rough surfaces. Named without deeper description, there are direct scattering problems, inverse scattering problems and clutter problems. Direct scattering problem is characterised by finding average properties of scattered signal when the surface properties are known. In case of inverse scattering problem one try to obtain statistical information about the rough surface from the characteristics of scattered field. Clutter problem is more less application of direct problem since properties of for instance ground clutters are sought and that information is used to better unwanted clutter suppression. There is clear the direct scattering problem is the problem of cross section prediction techniques and scattered field simulation method.

Important part of the prediction technique when reasonable precision of results is required of course is the equality of statistical parameters of surface model compared to natural surface. The same literature mentions following three types of rough surface models. First is so called semi-empirical model. This group of models for the most part offers the simplest results. All such models involve a set of arbitrary constants that are functions of the properties of the actual surface and are determined by matching the model to measured parameters of real surface. Second kind of model is geometrical model. These models employ a surface made up of deterministic or simple shapes arranged randomly over a planar area. There is example of the geometrical model, the vegetation-like rough surface model consisting of thin dielectric cylinders, arranged randomly but preferring a vertical orientation. Last type of model is statistical model, which treats the surface height above xy-plane as a random variable. That class of models is the most general and

provides results explicitly in terms of the average surface properties rather than arbitrary constants. The statistical models are the most suitable for numerical RCS prediction techniques and computer simulation.

## ROUGH SURFACE GENERATION

There are several various methods used for random rough surface generation and each of them produces surfaces with specific character. J. A. Ogilvy in his book, reference [2], gives more extend overview end description of those methods. In this stage of my work is not so important to have exact model of any natural rough surface, more important, in my opinion, is to have control above statistic parameters of created surface and to evolve their influence into scattering pattern.

The method that gives good possibilities to generate specific surface as a random function of surface height satisfying required statistical distribution, in that case Gaussian distribution, and the method that I used is moving average process.

### Theory of the moving average process

Three-dimensional surface characterised by dimensions along axes  $x$  and  $y$  and its height is in form  $h_{np}=h(n\Delta x, m\Delta y)$  with  $\Delta x$  and  $\Delta y$  discretisation intervals can be generated by:

$$h_{np} = \sum_{l=0}^N \sum_{m=0}^M w_{lm} \cdot u_{n-l, p-m} \quad (1)$$

where variable  $u$  is uncorrelated random variable and vector  $w$  is weight vector, which gives statistical character of created surface, especially shape of the correlation function. Its length  $N$  then determines the order of moving average process. Used random number generator and its quality has influence over random character of created surface

Weight matrix used to create surface with the Gaussian character of correlation function can have form:

$$w_{lm} = w_0 \cdot \exp \left\{ -2 \cdot \left[ \frac{(l\Delta x)^2}{\lambda_x^2} + \frac{(m\Delta y)^2}{\lambda_y^2} \right] \right\} \quad (2)$$

where  $\lambda_x, \lambda_y$  are correlation lengths in the direction  $x$  and  $y$ , respectively. Constant  $w_0$  specifies extension of  $h_{np}$ .

## WAVE SCATTERING COMPUTATION

The total field in presence of scatterer can be written as the sum of incident and scattered field:

$$\varphi(\vec{r}) = \varphi^{inc}(\vec{r}) + \varphi^{sc}(\vec{r}) \quad (3)$$

Then vectors  $\mathbf{k}_{inc}$  and  $\mathbf{k}_{sc}$  are the wavevectors of incident and scattered waves. If the wavelengths of those waves are equals and speed of propagation is not changed, wavenumbers are equals only directions are different.

$$\begin{aligned} \vec{k}_{inc} &= k\widehat{\mathbf{R}}_{inc} \\ \vec{k}_{sc} &= k\widehat{\mathbf{R}}_{sc} \end{aligned} \quad (4)$$

are the definitions of local incident and scattered wavevectors.

### Kirchhoff theory

According to Physical Optics or Kirchhoff theory the scattered field can be computed by:

$$\varphi^{sc}(\vec{r}) = 2j \int_S (\vec{n}_0 \cdot \vec{k}_{inc}) \varphi^{inc}(\vec{r}_0) \left( \frac{e^{jk|\vec{r}-\vec{r}_0|}}{4\pi|\vec{r}-\vec{r}_0|} \right) dS(\vec{r}_0) \quad (5)$$

Every four adjacent points of the generated surface model form a small planar rectangular patch of dimensions  $\Delta x$  and  $\Delta y$  with the normal vector  $\mathbf{n}$ . Algorithm is based on the idea of summing the scattered field contributions from all  $N$  times  $M$  patches. If the incident wave is assumed of spherically spreading then equation 5 becomes:

$$\varphi^{sc}(\vec{R}_r) = 2j \int_{S_{n,m}} A(\vec{r}_0) (\vec{n}_0 \cdot \vec{k}_{inc}) \left( \frac{e^{jk|\vec{r}_0-\vec{R}_s|}}{4\pi|\vec{r}_0-\vec{R}_s|} \right) \left( \frac{e^{jk|\vec{R}_r-\vec{r}_0|}}{4\pi|\vec{R}_r-\vec{r}_0|} \right) dS_{n,m}(\vec{r}_0) \quad (6)$$

where  $S_{n,m}$  is the area of computation of  $(n,m)$ -th patch at  $x_0=n\Delta x$  and  $y_0=m\Delta y$ . Vectors  $\mathbf{R}_s$  and  $\mathbf{R}_r$  are the vectors of source and receiver respectively with direction pointing from the origin.

The amplitude of incident wave  $A(\mathbf{r}_0)$  is constant over each patch in this applications but generally it is possible to define dependencies between amplitude and antenna pattern, frequency characteristics of the system or absorption characteristics of the surface.

### Roughness criterion

After the study of referenced literature, especially reference [1]. I know two approaches to compute electromagnetic field scattered from rough surface. There is one type of methods based on the perturbation theory that are useful for slightly rough surfaces. Next main kind of methods is derived from the Physical Optics and is represented by the Kirchhoff theory. These methods are sufficient mostly for higher degree of roughness than perturbation theory. It is necessary to define a criterion to decide if specified surface is still smooth or if it is rough and to divide slightly rough and rough surfaces.

One possibility is to use Rayleigh criterion, reference [1], chapter 1.2. This criterion is based on the comparison of phase differences between two parallel rays scattered from separate points of surface. Because these two rays are parallel their incident angles are equal  $\theta_1=\theta_2$ . Because they are scattered from separate points the heights of surface at these points are different  $\Delta h=h_1-h_2$ . Phase difference can be computed by:

$$\Delta\phi = 2k \cdot \Delta h \cdot \cos \theta_1 \quad (7)$$

The interference of these rays depends on  $\Delta\phi$ , of course. According to the phase difference we can decide that surface is smooth if  $\Delta\phi < \pi/2$ , otherwise it is rough. When Rayleigh parameter will be defined:

$$R_a = k\sigma \cdot \cos \theta_1 \quad (8)$$

where  $\Delta h$  can be replaced by RMS deviation of height  $\sigma$ . Then Rayleigh criterion of roughness becomes:

$$R_a < \frac{\pi}{4} \quad (9)$$

At this work I developed algorithms using only the Kichhoff theory that means I am working with surfaces with higher degree of roughness.

### Kirchhoff theory application

If the frequencies of incident and scattered waves are equal and environment of propagation is the same for both of these waves wavenumbers  $k_{inc}=k_{sc}=k$  hence I can denote:

$$\begin{aligned}\vec{R}_{inc} &= \vec{r}_0 - \vec{R}_s \\ \vec{R}_{sc} &= \vec{R}_r - \vec{r}_0 \\ \vec{k}_{inc} &= k\hat{R}_{inc}\end{aligned}\quad (10)$$

Then equation 9 can be rewritten to the form:

$$\begin{aligned}\varphi_{n,m}^{sc}(\vec{R}_r, \vec{R}_s) &= 2jA \cdot \int_{S_{n,m}} (\vec{n}_0 \cdot k\hat{R}_{inc}) dS_{n,m}(\vec{r}_0) \cdot \\ &\frac{1}{4\pi} \int_{S_{n,m}} \frac{e^{jkR_{sc}}}{R_{inc}} dS_{n,m}(\vec{r}_0) \cdot \frac{1}{4\pi} \int_{S_{n,m}} \frac{e^{jkR_{sc}}}{R_{sc}} dS_{n,m}(\vec{r}_0)\end{aligned}\quad (11)$$

The patches in this application are rectangular and planar the first integral – scalar multiplication of normal vector  $\mathbf{n}_0$  and wavevector of incident wave  $\mathbf{k}_{inc}$  – in equation 3.10 equation becomes equal to scalar multiplication of the normal vector  $\mathbf{n}_0$  and the wavevector in the midpoint of the patch  $\mathbf{k}_{incMID}$ .

$$\vec{k}_{incMID} = k\hat{R}_{incMID}\quad (12)$$

Then we have to solve two remaining integrals of the Green's function.

Principle of numerical solution is to divide rectangular patch into the sufficient number of rectangular sub-patches of dimension  $\Delta x_{sub}$  and  $\Delta y_{sub}$  for that it is possible to consider spherically spreading function as constant and to write for the  $(u,v)$ -th patch:

$$\varphi^{GR}(R) = \frac{1}{4\pi} \int_{S_{u,v}} \frac{e^{jkR}}{R} dS_{u,v}(\vec{r}_0) = \Delta x_{sub} \Delta y_{sub} \frac{e^{jkR}}{4\pi R} + C_{err}\quad (13)$$

The error constant  $C_{err}$  has to be smaller than tolerance limit defined on the beginning of the computation. The numerical integration was launched as the iteration process when each iteration adds one row and column of sub-patches

and instead of real error in sense of difference between planar and spherical spreading there is computed estimation of this error as the difference between two following iterations:

$$C_{est} = \varphi_i^{GR} - \varphi_{i-1}^{GR} \quad (14)$$

The  $U$  and  $V$  are numbers of sub-patches in the  $y$  and  $x$  direction of the  $(n,m)$ -th patch. This algorithm works with the equal number of sub-patches in  $x$  and  $y$  direction.

$$\begin{aligned} \Delta x &= U \cdot \Delta x_{sub} \\ \Delta y &= V \cdot \Delta y_{sub} \end{aligned} \quad (15)$$

Number of iterations is there denoted as  $i$ .

Practically it is in deed too long computation time to solve this integral by iteration process and to evaluate the same patch several times to fit the tolerance condition. Better solution is to find dependency between the final error estimation and number of patches  $n$  and  $m$  and to compute the Green's function  $\varphi^{GR}$  directly with the required precision. At this moment I have the approximation function of mentioned dependency tested only for patches that partial derivatives  $\partial h(x,y)/\partial x$  and  $\partial h(x,y)/\partial y$  are 0. On the figure you can see the plot function of number of sub-patches  $n$  for interval of relative tolerances  $c_{est}$  from 0.5 to  $10^{-5}$ . The relative tolerance is defined for complex  $\varphi^{GR}$  by:

$$c_{est} = \frac{|C_{est}|}{|\varphi_i^{GR}|} \quad (16)$$

Approximation function is because of the shape of dependency the logarithmic progression:

$$\bar{n} = c_0 + \sum_{i=1}^I c_i \cdot \ln c_{est}^{p+i} \quad (17)$$

where vector  $c$  is vector of coefficients having the length  $I+1$ .  $I$  is the number of progression's members. It seems to be reasonable to choose  $I=3$  and arbitrary parameter  $p=3$ . Then approximation function has the form:

$$\bar{n} = c_0 + c_1 \ln c_{est}^4 + c_2 \ln c_{est}^5 + c_3 \ln c_{est}^6 \quad (18)$$

The coefficient-vector  $c$  was found by least square method:

$$c = \begin{bmatrix} 3.6936 \\ 4.9558 \cdot 10^{-2} \\ 8.0617 \cdot 10^{-3} \\ 5.1790 \cdot 10^{-4} \end{bmatrix} \quad (19)$$

The vector of coefficients was computed as an arithmetic average of vectors evaluated for the patch of dimensions  $\Delta x_{sub}=1mm$  and  $\Delta y_{sub}=1mm$  “illuminated” from several directions and ranges (changing vector  $\mathbf{R}$ ) and by number of frequencies from X and Ku bands.

## CONCLUSION

Described algorithm was practically tested in Matlab as a set of m-functions. The most significant shortcoming of it was the computation speed. For instance I have launched this computation on rough surface of dimensions 30 cm by 30 cm divided on to square 1 mm – patches. When requested error estimation has been between  $10^{-3}$  and  $10^{-4}$ , the number of elements in every patch would be 100 by 100. You can imagine the consumption of computation power needed to solve the numerical integration using this algorithm.

On the other hand the advantage of used approach is the flexibility of computation. There exists the possibility to extend algorithm and to compute curve-shaped surface of the patches. That is the way to compute 3D-cubic spline approximations of curved surfaces, of course with the redefined approximation function.

## REFERENCES

- [1] Oglivy, J. A., Theory of wave scattering from random rough surfaces. Institute of physics publishing, Bristol and Philadelphia, 1991.
- [2] MATLAB Electronic Documentation System, MATLAB Help.
- [3] Ruck, G. T., Barrick, D. E., Stuart, W. D., Krichbaum, C. K., Radar Cross Section Handbook, Plenum Press, New York, 1970.





## RESUME

### **GODZIMIRSKI, Jan—ZALEWSKI, Piotr**

*Aviation Education on Military University of Technology, Warsaw*

The Faculty of Armament and Aviation Technology of the MUT especially its Institute of Aviation Technology is exclusively responsible for education and training of the commanding logistic personnel for the Aviation of all Polish Armed Forces. The gradutors of the MUT are in charge for management of the maintenance, overhaul and depot of all the aircraft in service of the PAF.

Due to fact that the modern aircraft is a very complex structure, since 1998 a new study domain called mechatronics has been launched and the faculty has been opened for civil students. New aviation courses and their curriculum were fully accepted by both Department of Defence and Ministry of Education and proper international standards were fulfilled such as: FEANI and ECTS. The faculty offers three staged flexible education systems in the field of aviation engineering leading to, respectively: B.Sc, M.Sc. and PhD degree.

### **SUNDQVIST, Bengt-Göran—PERSSON, Andreas—PELLEBERGS, Johan**

*Automatic Aircraft Collision Avoidance System for Air Combat Maneuvering*

Auto-ACAS is a joint US-Swedish program aiming at developing and flight testing an Automatic Aircraft Collision Avoidance System. This paper will present the Auto-ACAS system including a more detailed description of the algorithm.

The overall Auto-ACAS objectives are:

- Detect potential collisions.
- Activate and execute an avoidance maneuver at the latest possible instant.
- Nuisance free operation.
- Failure Safe Operation.

### **Klára Siposné, KECSKEMÉTHY—KORMOS, László**

*Remarks and Ideas about Future Aviation Technologies Symposium and Military Aircraft Personnel Training*

It's a good and progressive tradition at the Aviation Technical Institute (belonging to the Bolyai János Military Technical Faculty) in Szolnok, to organize Future Aviation Technologies Symposium yearly, on the occasion of the 12<sup>th</sup> of April, the Day of Astronauts.

The institution of the Future Aviation Technologies Symposium was established in 1991 by the section of Air Defense Department of the Hungarian Association of Military Sciences in Szolnok, and since then it has been held every year.

It's remarkable, that the Symposium has traditionally both military and civilian characters. Consequently we have a great opportunity to learn the result of both military and civilian research, to cooperate and to exchange experiences, - it is important for a small country's small Air Force and small defense university. It can be regarded progressive, supportable and sustainable. We need to underline that the Symposium provides a forum for young PhD students and other students who are interested in this field. The hard copy issued on the Symposium's material provides additional source to utilize the collected experience.

When we say the military and civilian character of the Symposium is to be sustained, we assume the further cooperation between the Szolnok Base (the education of the Air Force's personnel) and the Future Aviation Symposium in the future. Interruption of this process would be harmful for the military specialist education, accordingly not advantageous for the Air Force, as well.

I am very glad to highlight the international character of today's session because the presence of the foreign colleagues levels up the standard of this event and increases the quantity of experiences to be utilized.

### **RADUCANU, Dan**

#### *Integrated Image Intelligence System (I3S)*

The I3S concept (Integrated Image Intelligence System) represents an important step for autonomy in the IMINT (IMage INTelligence) field (obtaining information by aerospace imagery photointerpretation and analyses). An independent country should have the control of its own IMINT information source to manage and monitor the national and boundary territory.

This paper aims to present the I3S operational missions, the structure of a military intelligence center (MIC) and the I3S facilities for training and services.

### **MRÁZ, István**

#### *Leadership Qualities on the Future Battlefield*

In my opinion the topic of the present symposium is very up to date in terms of the current technical development. Education should be based on the knowledge of the future. But we all live in a very special organisation the military. Our mission is combat, and the international experiences showed us some important aspects of the battlefields. There is more than one side to the coin. On the battlefield of course one is technical quality, level on high technology, but the other is human factor.

**SZABOLCSI, Róbert—SZEGEDI, Péter**

*Design of the Chebyshev BR Filter for the Elastic Aircraft Longitudinal Stability Augmentation System*

The paper deals with dynamic behavior of the elastic aircraft and with its properties. In preliminary papers of the authors it was stated that stability augmentation systems may have lack of robust stability if to involve dynamics of the elastic overtones of the aircraft fuselage. Robust stability may be ensured if to design and apply the Chebyshev BR filter in the feedback path of the analog Chebyshev BR filter. For the solution of this problem the MATLAB and Simulink computer packages will be used.

**Ms. MOLDOVAN, Elena—JULA, Nicolae—LUPAS, Anca**

*Pressure Microtransducers as Dynamic Linear Systems*

The present work travels some experimental and theoretical aspects upon the best conditions of the working of a sylphon, as an elastical element of a traductor. The sylphon deformation under inside pressures is transformed into a simple axial stretching that can be more easily measured.

This product is frequently used as a sensitive element in aviation, contributing to the aviation systems automatisation.

**DUNAI, Pál**

*Practical and Psychological Aspects of the Training Process for the Guided by their Abilities Hungarian Military Forces in the 21st Century*

The challenges of the 21st Century can be able to answer only that Hungarian military force which was renewed in his training levels and intellectuality and will be able to integrate into the Euro-Atlantic defence system accordance with the NATO's requirements. This process remarkably increases the importance of the training in the subordinate unit and this fact will support advantaged requirements with the subunit commander staff independent of their branch of military service. The success of the training's process will highly depend on the pedagogical and psychological skill's level of the subunit commander staff. The individual skill level and pressure of the exemplification have highly preferred role in the motivation system. This article should try to systematise the body of knowledge in this area and tries to take a few conclusions for the Hungarian force, in the first place some exact conclusions and helps for their practical using in the Hungarian Air Force's training system.

**PADÁNYI, József**

*Engineer Support to SFOR Air Operations*

This presentation describes the Role, Responsibilities and Tasks of SFOR Engineers on Peacekeeping Operation, concentrates on Air Operations. Included are examples of successful projects and procedures.

**STANCIU, Virgil—BOSCOIANU, Mircea**

*Contributions to the Study of an Axial Compressor Stage by the Means of the Generalized Reaction Degree Concept*

The authors present a research concerning the total reaction force that appears in the stage of an axial compressor  $F_T$  which is given by the summation of the reaction force developed into the (rotor) row blades  $F_R$  with the one developed into the (stator) nozzles,  $F_S$ .

The generalized degree of reaction  $R_c$  being a function of the ratio  $l_c^*/i_1^*$ , depends mainly on the magnitude of the mechanical work on the compression  $l_c^*$  and the value of the pressure ratio  $\pi_c^*$ , respectively and it is influenced by the ambient and flight conditions (in terms of pressure, temperature and flight speed) by the means of the total enthalpy,  $i_1^*$ .

It follows up that a more general way to optimize the flow into an axial stage of a compressor is to take into consideration the relation between the mechanical work on compression and the generalized degree of reaction.

**DANCZIK, Ján—HÝBL, Miroslav**

*Automatic Landing System for UAV*

The Unmanned Aerial Vehicle (UAV) system is designed for the real time safe and low cost TV or IR aerial reconnaissance, monitoring of contaminated and inaccessible areas, artillery fire monitoring, radio reconnaissance and jamming, border patrol, search and rescue (SAR) assistance, or it can be used as an aerial target.

UAV control is either semi- or fully automatic. The flight plan can be preprogrammed before take-off or during flight.

Navigation is via GPS and there is real-time data-link between the UAV and its Ground Control Station (GCS), allowing the ground crew to monitor real-time on-board optoelectronic sensors and the airplane position (displayed on a digital map). The main flight data are displayed on displays at GCS.

In the article, there is a proposal of theoretical control design of UAV. We assume, the vehicle will return to the landing area after finishing its mission. In the landing area, the vehicle will be guided to the straight axis of the runway. The

guidance of the vehicle to the appropriate direction is made manually or automatically. From the defined distance the vehicle begins descent on the glide slope. On the descent on the glide slope at the altitude at about 25-30 m the control of UAV is switched to the fully automatic regime, in which the UAV is guided to the landing point.

The landing trajectory is theoretically of the exponential shape. Choosing appropriate exponential parameters and using correct control system, it is possible to ensure optimal flight trajectory from the beginning switch to the automatic descent to the touching the runway.

The control system is composed of the fuzzy control system, which controls the flight parameters during the landing process.

### **LUŽICA, Štefan**

*Distortion Solution of the ILS Localizer Course Line by PC Support*

Correct aircraft guidance in the phase of precision approach to landing rest in maintenance of the Instrument Landing System (ILS) course line and glide path in the prescribed values and without any distortion. The distortion of the ILS course line is caused by reflections of the transmitted electromagnetic waves from surface irregularities that can occur inside of the ILS covering area.

The work is oriented at analytical determination and graphic presentation of the ILS course line distortion by PC support. Attained results in the work are applicable both to the teaching process and airfield radio engineering support of the Air Force.

### **SIKLÓSI, Zoltán**

*The NATO Standard Safety Investigation Procedures which should be Integrated into Home Regulations*

The Hungarian safety investigation concept differs in many ways from the NATO standards. First of all the home regulations don't make difference between safety and departmental investigations. This is the reason why they don't so effective.

Usually the accidents are caused by adverse interactions of man, machine and environment. Investigations and assessment of these elements should reveal human, material and/or environmental factor that caused or contributed to one or more system inadequacy (deviations). These deficiencies are usually attributable to leader, standards, training, individual, or support failure. Although an accident occurs "after the fact" its primary focus must be an identifying what happened and why it happened.

After the identifying system inadequacy the appropriate activity(s) responsible for correcting them should be notified. This is the “3W” approach to information collection, analysis and remedial measures.

The procedures are designated to assist us find answers the following basic questions:

- When did the system inadequacies (error, failure, environmental factor injury) occur?
- What happened? (human, material, environmental factor injury)
- Why did it happen? (system inadequacies, root cause(s))
- What should be done about it? (remedies for system inadequacies root cause(s))

Highlight the significant elements of the safety investigation from different point of view; this is the goal of my short presentation.

### **GRECMAN, Pavel**

#### *Utilization of Self-protect Systems on Recent Helicopters Used by Czech Air Force*

Systems of self protection used by Czech Air Force (CAF) are behind the times by their technology and their concept. That equipment was developed mostly based upon the experiences from the Soviet war in Afghanistan and now with respect to interoperability in frame of NATO and character of probable treats in assumed missions are applicable with really extensive limitation.

Analyze of current state gives requests to apply modern self-protect systems only to two types of helicopters used by CAF. First of them is the multi-role helicopter Mi-17 that is mainly intended for transport of persons or cargo. Second one is Mi-24, the combat helicopter that is proposed for missions including direct air support, antitank attack, armed escort, air to air combat and reconnaissance as well as to transport troops or serving for SAR tasks.

Recent equipment of both of these types of helicopters for self protection is not sufficient enough to be used under current conditions (requests are to be equipped by autonomous RWR and CMDS). Hardware realization of most of the used warning receivers does not give us the possibility to modernize them or to extend their data library. They have not a capability to record data from mission and after the end of the mission a possibility to evaluate these data by specialists. Next serious shortcoming of those warning receivers is missing direct connection between them and CMDS.

### **VARGA, Béla**

#### *Noise Reduction Methods of Modern Single Rotor Helicopters*

In the early days of helicopter manufacturing the main purpose was to develop the performance of helicopters and they didn't take into consideration such

problems as the high noise emission. But nowadays the new local and international stricter noise certification standards have made it the hottest issue for helicopter manufacturers.

Growing public sensitivity to helicopter noise has forced the major rotorcraft manufacturers to be innovative in reducing measured and perceived external noise levels of their products. We can say that they have successfully solved many of their problems and use a variety of technologies and design solutions to reduce noise.

In this work I would like to present these new ways in helicopter design and to highlight their positive effects.

### **KULCSÁR, Balázs—KORODY, Endre**

#### *Pull-Up from a Dive*

In case of some type of aircraft, like military and acrobatic exists the pull-up from a dive manoeuvre. Pull-up from a dive is a curved line motion in vertical plane, in which an aircraft flying with negative pitch angle is constrained suddenly to fly horizontal or with positive pitch angle under the effect of the elevator. In some cases at pull-up from a dive, the loading factor can be higher than the loading factor associated to physiology or to aircraft structure. At the same time, an aircraft flying with given velocity can not make pull-up from a dive under a minimal altitude.

In this paper it is presented the analysis of the minimal altitude (in function of the entrance velocity in pull-up from a dive manoeuvre), which assures security according with the restriction factors.

### **JAKAB, László**

#### *Experiences of Command Sergeant Major (CSM) Course in the Air Force*

Joining the NATO on the 12 of March 1999 meant a decisive change for Hungarian Army. The inherited constitutional structure and military skills couldn't be fitted to the structural system of the NATO. A strategic revision, which was needed to the reorganising of the Hungarian Army — and within it the Air Force — was fulfilled in 1999. As the result of the strategic assessment, among others, Command Sergeant Major (CSM) assignment appeared on establishment tables in the Air Force, too. The authorisation of these assignments was explained by the fact, that the authority, the right, the responsibility and tasks of commissioned and non-commissioned officers were different in the forces of the NATO and in Hungarian Army. The role of non-commissioned officers „is aimed at efficient professional operating, handling, maintenance and repairing of military objects and leading of small subunits”.



**ANDRLE, Milos**

*Using of the Data Output of the Modernized Precision Approach Radar for Aircraft Navigation*

This paper is focused on looking for the new sources of the navigation information for other increasing of the reliability and accuracy of the control of the aircraft during the Approach. There are several alternatives, one of them is the transfer of the data output of the modernized Precision Approach Radar RP-5M on the board, its data processing and indication for the cross track deviation display. The Multinavigation System might be realized by the application of the data navigation PAR together with the output information ILS and the DGPS, if needed by the other sources of the navigation information (DME, RALT, Encoder). This Multinavigation System makes the choice 1 of 3 systems by the guidance of the aircraft during the Approach: ILS, DGPS, PAR or their optimal processing, with the application of the Kalmann's filter.

**VOSECKÝ, Slavomír**

*Integrated Fix Information*

The article reminds fundamental objectives of EUROCONTROL Strategy for the ECAC States from civilian/military co-operation needs point of view. The need to realize the Integrated Air Control Centres (IACCs) around Europe is mentioned. Main properties and accuracy levels of all sorts of air surveillance systems available are discussed. A corresponding possibility and procedure of integration of the three sorts of aircraft fix information is suggested.

**TKÁČ, Jozef—ŠPIRKO, Štefan—BOKA, Ladislav**

*Radar Target Detection with Reduced Radar Cross Section*

The main approach to the Radar Cross Section reduction and possibilities to detect targets with reduced Radar Cross Section are discussed. The multiposition radar system is suggested to detect flying targets. The main problem in multiposition radar system results from the necessity of coordination and synchronisation of different position. Some of these problems are discussed and use of commercial transmitters as illumination sources are described. These sources can be for example TV, radio broadcasting net or mobile telephone for short range, or special transmitter for long range. Signal processing can be done in time-domain by real time digital relay correlator.

**POKORÁDI, László**

*Fuzzy Logic-Based Maintenance Decision*

The real world has some uncertainty and people do not always use precise definitions. The very great experience of engineers and technicians is similar to the real world's feature mentioned above. The fuzzy logic based methods can be used to make maintenance management-decision. This paper shows an example to determine time between state-estimation and permissible parameter values.

**OLEJNIK, Aleksander—KACHEL, Stanislaw—LESZCZYŃSKI, Piotr**

*Recreation and Evaluation of the Aging Aircraft Structure for the need of Lifetime Extension*

In the paper a comprehensive approach for the reconstruction of the existing aviation structures in a computer virtual reality is presented. The elaborated techniques can be applied to assessment of the ageing fleet of the fixed as well as rotary wing aircraft used by the Polish Air Force. The Russian-made Su-22, the prime attack aircraft of the PAF was selected as a sample for strength evaluations.

Generally speaking, it was a very difficult and complex task, because the PAF doesn't have a complete technical documentation and maintenance depot or overhaul technology of the considered aircraft.

**HUSI, Géza**

*Why I like the  $(ax^2 + b)/x$  function?*

The  $(ax^2 + b)/x$  function is a very important function for production and operations managers and for reliability and maintenance experts, in other words: technical managers. They usually use this function to find the optimum solution to technical problems.

I would like to show some application of  $(ax^2 + b)/x$  function.

**TÓTH, Sándor**

*Values, Harmony, Social and Army*

The countries of Central Europe have successfully implemented procedural democracy through the simultaneous transformation of their economic, political, social, legal and constitutional, and military structures. This stands in contrast to the experiences of the countries of Southern Europe (Greece, Spain, Portugal)

which underwent recent transitions to democracy, but which sought to first transform their democratic structures and delay the more difficult and politically costly reforms relating structural economic change until the situation in the country became stabilised. The simultaneity of Central European reforms across all main sectors has made the task of defence reform all the more challenging, as the defence and military sector must contend with competing social and economic priorities. Such a context, I believe, highlights both the degree of commitment to reforms and the extent of success the Central and Eastern European countries have already experienced.

**RÁSA, László**

*Models of Changing Organisational Cultures Adequate to the Reorganisation of the Hungarian Defence*

Forming and managing organisational culture is a management task that is by no means impossible. There exists a pretty rich management literature on cultural change that is taken for a long-term strategic issue of organisational leadership.

As mentioned above, social impacts demolishing cultural values have reached the organisational culture of the National Defence in abundance after the political changes. Neither the political, nor the military leadership has taken steps to revitalise it. Spontaneous processes of cultural change and the alteration of values forced by various power groups have led to a distortion in the military culture. The military leadership of this era has not been able to create a new cultural value system that would positively influence the functioning of the organisation. The “Socialist” value system was torn out of the culture of the defence forces and its replacement with a “Democratic” one has been without success.

Nowadays, when in all modern armies of the world it is the human individual (and not the technology) that is held for the key factor of effective military operations, the Hungarian Defence Forces have no other way to go.

**PINTÉR, István**

*Levels of Leadership*

Leadership has been defined by many different disciplines in the past. There are psychological, interpersonal, and sociological concepts of leadership in the behavioral sciences; there are historical, allegorical, and fictional examples in the humanities; and there are obvious assumptions in microeconomics, operations research, and quantitative finance.

## **BÁNYAI, Kornél**

### *Military Background and Leadership Skills in the Business Life*

Is that right that the demobilized army officers are better leaders in the business life than others? Do they have significant advantage in leadership skills? The presentation would like to examine the fit between their own military based leadership style and the business culture in which they work, know how to adapt their leadership style to business, how can they influence, motivate and lead others, how can they use their power and influence to build support across the organisation for their and the company's success.

## **PETÁK, György—BÉKÉSI, Bertold**

### *Gripen for Hungary. Why the Gripen is the Best Solution*

We would like — in our briefing — to give you a short, but essential overview about the main characteristics of the Gripen, which is a fourth generation, multirole, fighter aircraft.

Scope:

- main technical and aerodynamic characteristics;
- the multirole capability;
- NATO interoperability;
- operation and maintenance;
- advantages of the aircraft lease;
- economic, tactical and weapon systems development possibilities in the future.

It is a briefing, which can explain why the Hungarian government selected the Gripen for the lease.

## **ZALEWSKI, Piotr**

### *Selected Aspects of the Modern Fighters Evaluation*

In the paper, an assessment of combat capabilities of fighters is presented on the base of a selected group of the modern multirole military aircraft. The evaluation was carried out by means of comprehensive method adapted by based on the matrix calculus. A modern multirole fighter is designed to carry out various air operations; therefore the special areas can be determined (depending a sort of the mission) which are important from the point of view of mission success. These areas, for the modern fighters, can be described by: weapon system, avionics, manoeuvrability, mission flexibility etc. The determined areas should be investigated through the process of identification of parameters or indicators, which represent any area, and then parameter matrixes should be aggregated and normalised. A final ranking of combat capabilities of the aircraft would be achieved after accumulation of the scores for the investigated areas.

**BOSCOIANU, Mircea—STANCIU, Virgil**

*An Analysis of the Axial Flow Compressor Stability Using the Bifurcation Theory*

The authors present a research concerning the application of the bifurcation theory to a single harmonic version of the Moore–Greitzer model for axial flow compressor stability.

It is possible to reduce the Moore–Greitzer model for compressor instability to a set of three ordinary differential equations using a one-mode truncation. The three ordinary differential equations were studied using the methods of bifurcation theory, which gave the boundaries in space parameter for each type of solution. Finally, the authors stress the importance of the shape of the rotating stall characteristic. This analysis shows the qualitative differences between classic surge (a smaller amplitude oscillation involving a mixture of rotating stall and surge) and deep surge (a mostly axisymmetric oscillation with large variation of mass flow that during part of the cycle the compressor is operating in reverse flow). The analysis shows the qualitative difference between deep surge and classic surge. The bifurcation analysis is of great value in the study of compressor instability. It provides a complete picture of the parametric effects in this simple model.

**ROTARU, Constantin**

*Issues about Aircraft Turbojet Engines Control Laws*

This paper presents a mathematical pattern of the plot of the line functioning regimes of the compressor of a turbojet engine, which allows analyzing the possibilities of control so that improved flight characteristics are obtained. The pattern can be applied to the multishaft engines and to the turbofans. The paper stresses the influence of the exit section from the combustion chamber on the position of the line of the functioning regimes and also the possibility of improvement of the performances of the turbofan, by the modification of the area of this mixture section.

**MAKULA, Petr**

*Data Link Conception for Joint Tactical Unmanned Aerial Vehicles Based on STDMA Protocol*

Effective utilization of joint tactical unmanned aerial vehicles (acquisition of useful visual information about battle area) needs reliable and precise control of those vehicles and design of dependable crash-proof secure data links among UAVs and control station (CS).

Depending on character of signals, which are used for transmission of TV image, telemetric data and command control, there should be requirements of the radio channel and data link architecture. Because radio communication systems operate in environment causing a lot of errors and interference due to jamming, multipath propagation and noise there should be implemented modern methods of source and channel coding, adaptive equalization and digital modulation. Another digital communication concept is spread spectrum system, which has several positives like combating or suppressing the detrimental effects of interference, hiding a signal by transmitting it at low power and achieving message privacy. If the cooperation of several UAVs in the battle area is required we have to design system based on some multiple access protocol. Because the modern UAVs are mainly equipped with GPS/NAVSTAR receiver, which can provide precise time reference for synchronization the utilization of the STDMA architecture seems to be very suitable. Modern sophisticated data links already cannot be designed in common manner but only with respecting to new design procedure like software oriented radio conception.

**HAMMARBERG, Bengt—BERGLUND, Hans**

*The SAAB NetDefense Concept*

The Swedish armed forces will be drastically re-organized within the coming decade according to a government bill accepted by the Swedish parliament 1999. The emphasis will be put on what is called Net Centric Warfare, NCW, to certain extent at the expense of the traditional armed forces. Instead the system will allow them operate in more efficient way than before. This process has already started.

It should be mentioned that the ideas behind this change came from the US but there is probably no country where the plans have proceeded further than in Sweden.

The presentation represents Saab's view on NCW which we call the Saab NetDefense Concept, in particular with respect to the role of Unmanned Aerial Vehicles, UAVs.

**LUDVÍK, František—MARTIN, Šimaček**

*Unmanned Air Vehicles – Critical Target*

The paper deals with Unmanned Air Vehicles, which can be considered as important so called "critical" targets. They in the time being can fulfil mainly reconnaissance tasks, but in a near future can also be important means for combat missions, i.e. due to a respective armament at the UAV board.

UAV therefore will play serious role in modern armies' armament, i.e. means against which should be necessary to accept proper counter measure in the whole Air Defence system.

**MARINESCU, Marin—MATEI, Lucian**

*Fuzzy Control of the Antilock Braking System of the Plane's Landing Gear*

This paper presents a new approach in controlling the Antilock Braking System working on a plane's landing gear. The present controller induces high stresses, both pneumatic and mechanical resulting in a fast wear of the components. The Fuzzy Logic Controller is smoothening the behavior of the system hence a small increase of the stopping distance occurs. Computer simulation have also been performed, and a comparison between the present and the proposed systems have been achieved.

**BOJDA, Petr**

*Algorithm Computing Electromagnetic Wave Scattering from Rough Surfaces*

The goal of this work is to develop tools for computer modeling of electromagnetic wave scattering from the rough surface.

First part is focused to create rough surface by using moving averages method of random surface generation and generation of surfaces possessed of Gaussian height distribution. This chapter also contains description of analyze tools.

Second part is dedicated to scattering computation and to evaluating of field intensity above rough surface. Basic is the algorithm using numerical evaluation of Green's function integrals. The truthfulness of the results is tested on smooth flat plate examples and compared to results computed by the other software.