

# CONCRETE STRUCTURES

ANNUAL TECHNICAL JOURNAL

Károly Péter Juhász – Péter Schaul

## **SYNTHETIC FIBRE REINFORCEMENT IN CONCRETE TRAMLINES**

2

Abdelmelek Nabil – Éva Lubláy

## **DIFFERENT PROPERTIES OF STEEL FIBRES REINFORCED CONCRETE - REVIEW ARTICLE**

8

Naser Alimrani – György L. Balázs

## **PRECAST CONCRETE HOLLOW CORE SLABS EXPOSED TO ELEVATED TEMPERATURES IN TERMS OF SHEAR DETERIORATIONS - REVIEW ARTICLE**

22

Mohammed Abed

## **SELF-COMPACTING HIGH- PERFORMANCE CONCRETE IN TERMS OF MIXING PROPORTIONS AND PROCEDURE**

21

Viktor Hlavička – Éva Lubláy

## **EXPERIMENTAL STUDY ON THE BEHAVIOUR OF BONDED ANCHORING SYSTEMS IN FIBRE REINFORCEMENT CONCRETE**

28

## **REPORT ABOUT CCC2017 TOKAJ**

34



2018

Vol. 19



# FERROBETON

safe basis provided by concrete

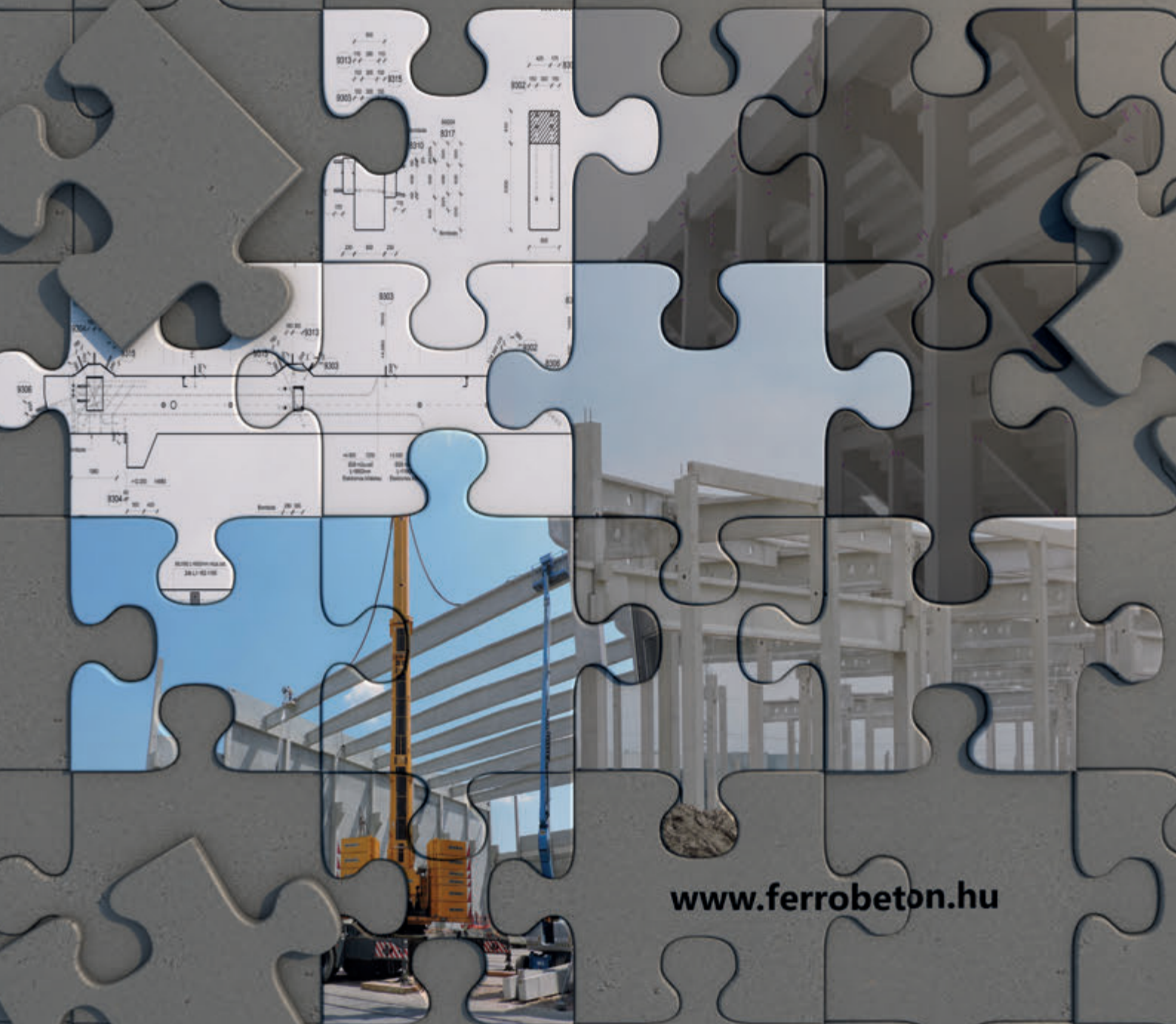

[www.ferrobeton.hu](http://www.ferrobeton.hu)

**Editor-in-chief:**

Prof. György L. Balázs

**Editors:**

Prof. Géza Tassi

Dr. Herbert Träger

**Editorial Board:**

János Barta

Assoc. Prof. István Bódi

Dr. Béla Csíki

Dr. Olivér Czoboly

Assoc. Prof. Attila Erdélyi

Prof. György Farkas

Gyula Kolozsi

Assoc. Prof. Katalin Kopecskó

Assoc. Prof. Kálmán Koris

Assoc. Prof. Imre Kovács

Dr. Károly Kovács

Assoc. Prof. Tamás Kovács

Ervin Lakatos

Assoc. Prof. Éva Lublós

László Mátyássy

Assoc. Prof. Balázs Móczár

Assoc. Prof. Salem G. Nehme

Assoc. Prof. Zoltán Orbán

Zsuzsa Pisch

László Polgár

Assoc. Prof. István Sajtos

Antonia Teleki

Dr. László Tóth

Attila Várdai

Assoc. Prof. István Völgyi

József Vörös

**Board of Reviewers:**

Prof. Endre Dulácska

Antónia Királyföldi

Prof. Péter Lenkei<sup>†</sup>

Dr. Miklós Loykó

Botond Madaras

Dr. Gábor Madaras

Prof. Árpád Orosz

Prof. Robert Ratay

Prof. Kálmán Szalai

Dr. Ernő Tóth

Founded by: Hungarian Group of *fib*

Publisher: Hungarian Group of *fib*

(*fib* = International Federation for  
Structural Concrete)

**Editorial office:**

Budapest University of Technology  
and Economics (BME)

Department of Construction Materials  
and Engineering Geology

Műegyetem rkp. 3., H-1111 Budapest

Phone: +36-1-463 4068

Fax: +36-1-463 3450

WEB <http://www.fib.bme.hu>

WEB editor: Dr. Olivér Czoboly

Layout and print: Csaba Halmai,  
Navigar Ltd.

Price: 10 EUR, Printed in 1000 copies

© Hungarian Group of *fib*

HU ISSN 2062-7904

online ISSN: 1586-0361

Cover photo:

Concrete protects environment

Photo: G. L. Balázs

## CONTENT

- 2** Károly Péter Juhász – Péter Schaul  
**SYNTHETIC FIBRE REINFORCEMENT  
IN CONCRETE TRAMLINES**
- 8** Abdelmelek Nabil – Éva Lublós  
**DIFFERENT PROPERTIES OF STEEL FIBRES  
REINFORCED CONCRETE-REVIEW ARTICLE**
- 22** Naser Alimrani – György L. Balázs  
**PRECAST CONCRETE HOLLOW CORE SLABS  
EXPOSED TO ELEVATED TEMPERATURES IN TERMS  
OF SHEAR DETERIORATIONS –  
REVIEW ARTICLE**
- 21** Mohammed Abed  
**SELF-COMPACTING HIGH-PERFORMANCE CONCRETE  
IN TERMS OF MIXING PROPORTIONS AND  
PROCEDURE**
- 28** Viktor Hlavička – Éva Lublós  
**EXPERIMENTAL STUDY ON THE BEHAVIOUR  
OF BONDED ANCHORING SYSTEMS IN FIBRE  
REINFORCEMENT CONCRETE**
- 34** **REPORT ABOUT CCC2017 TOKAJ**

Sponsors:

Railway Bridges Foundation, ÉMI Nonprofit Ltd., HÍDÉPÍTŐ Co., Holcim Hungary Co.,  
MÁV Co., MSC Consulting Co., Lábatlani Vasbetonipari Co., Pont-*TERV* Co.,  
UVATERV Co., MÉLYÉPTEK KOMPLEX Engineering Co.,  
SW Umwelttechnik Hungary Ltd., Betonmix Consulting Ltd., BVM Épelem Ltd.,  
CAEC Ltd., Pannon Freyssinet Ltd., STABIL PLAN Ltd., UNION PLAN Ltd.,  
DCB Consulting Ltd., BME Dept. of Structural Engineering,  
BME Dept. of Construction Materials and Technologies

# SYNTHETIC FIBRE REINFORCEMENT IN CONCRETE TRAMLINES

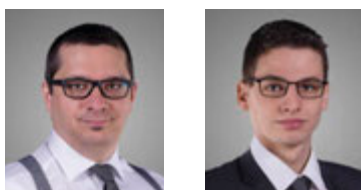

Károly Péter Juhász – Péter Schaul

DOI: 10.32970/CS.2018.1.1

*In the past decade macro synthetic fibre reinforcement has become widely used for concrete track slabs including tramlines. By using macro synthetic fibres as a reinforcement in concrete slabs both the casting time and manual work will decrease, while the concrete's ductility will increase. In most cases the steel reinforcement can be omitted entirely from the structures using macro synthetic fibres. The uniformly distributed fibres in the concrete can increase the residual flexural strength of the concrete independently from the location. This makes it possible to use the fibres in both cast in situ and precast elements used for tramlines. The calculation process for these structures always has to comprise of both the static load, the dynamic load and the effect of cyclic loading, i.e. fatigue. These load calculations can be handled using advanced finite element analysis software, which is specialized for concrete and fibre reinforced concrete structures. The paper will present the opportunities for using macro synthetic fibres together with the process of designing fibre reinforced concrete tramlines.*

**Keywords:** macro synthetic fibre reinforced concrete, finite element analysis, tramline design, concrete track slab

## 1. INTRODUCTION

Today the construction of modern concrete slab track plays a prominent role in the construction industry. Besides keeping in mind having an economic solution, more emphasis is placed on its durability and its resistance to environmental factors such as moisture, de-icing salts etc. The economic solution can be achieved primarily by decreasing the thickness of the slab and shortening the construction time. Durability can be significantly increased by designing for fatigue and by using materials that are resistant to these environmental factors. Because of this macro synthetic fibres are being used more often for the reinforcement of the concrete for both cast in place or precast structures.

Corrosion resistance is the greatest benefit of macro

synthetic fibre where durability can be assured but also synthetic fibres behave better with dynamic loads than steel fibres, therefore their use for tramline or railway track slab is very favourable. Added to this are the economic advantages such as a reduction in labour that would traditionally set and tie the steel reinforcement into place.

The first macro synthetic fibre reinforced track slab was constructed in Japan in 2002: Elasto Ballast track railway (Ridout, 2009). The goal of using macro synthetic fibre was, beside from the reduction of the vibration and noise, to increase the speed of the construction process. The track slab was made using a traditional slab structure with pre-stressed concrete sleepers on it supporting the rails (fig 1). The reinforcement was a hybrid of traditional steel bar reinforcement together with macro synthetic.

**Fig 1:** Elasto Ballast track railway (Ridout, 2009)



The first synthetic fibre reinforced track slab in Europe was the Docklands Light Railway near London in 2004. The slab was reinforced with 6 kg/m<sup>3</sup> macro synthetic fibre reinforcement (BarChip48 high quality macro synthetic fibre) which made the construction process considerably faster (Ridout, 2009).

The first only macro synthetic fibre concrete cast in place tramline in Europe was built in Szeged, Hungary. Macro synthetic fibre was considered over steel reinforcement as at a certain point in the track it was not possible to use any steel reinforcement due to the operation of a special switch that collected stray current and so this part of the track was reinforced with macro synthetic fibres. Because of the positive experiences and cost saving in this part of the track the contractor changed to this solution for the entire track and thus replaced all the steel reinforcement with macro synthetic fibres (Nagy et.al. 2014; Nagy et.al. 2015a; Nagy et.al. 2015b).

Beside the cast in place solution the use of precast concrete tramline elements started to spread, mainly because of the same benefits of shortening construction time. These elements also needed to be designed for temporary situations, such as demoulding, lifting, transporting and placing on site. The first and only macro synthetic fibre reinforced precast concrete track to date is the PreCast Advanced Truck (PCAT) system (Hammond, 2016). This precast element is highly optimised both by the dosage of the fibre and its geometrical shape.

In this paper both the cast in place and precast macro synthetic fibre reinforced concrete tramline structures and their design processes will be presented.

## 2. CAST IN PLACE TRAMLINES

One of the most common structures for tramlines is the cast in place track slab. There are several proprietary track slab configurations commonly using either the poured in place form worked track slab or the track slab extruding machine. In the first case after installing the formwork the slab is filled with macro synthetic fibre reinforced concrete, and the joints are installed after each section of the track slab is poured. Each pour is then mostly connected with steel dowels. In the second case the machine continuously pours the macro synthetic fibre reinforced concrete between the moving formwork. In this case the joints are made by saw cutting the slab, which reduces the likelihood of any crack formation.

### Szeged tramline

In 2010 and 2011, during the extension and reconstruction process of the A and C sections of tramline Nr. 1 in Szeged (fig 2.) in an areas of the so-called loops which was a major tram intersection, it was necessary to have concrete track slabs that contained no steel reinforcement. Therefore, it was an idea to use macro synthetic fibre-reinforced concrete in these sections. At that time, only synthetic microfibers had been used for concrete reinforcement in Hungary, the effects of which are mostly seen in the case of fresh concrete: through reducing the rate of plastic shrinkage cracking. However, in hardened concrete only macro synthetic fibres have any structural impact. While exploring foreign technologies, it was found a suitable building material for this purpose a Japanese-developed macro synthetic fibre. During the design process it turned out that traditional reinforcement could entirely be replaced by the use of this macro synthetic fibre in this application. After a technical and financial



Fig 2: Tram line in Szeged, Hungary

analysis it also became clear to the general contractor that the desired structure could be built more economically and faster, furthermore: not only could it be applied in the critical sections where no steel reinforcement was allowed, but also it could be used in the other sections of the tram tracks. Based on the above, a unanimous consensus was reached by the Client, the General Contractor and the Designer to try out the new technology. The new technology was designed for and initially tested on non-critical track areas (RAFS-CDM) such as at road junctions, turn-outs, current tracks, bus bays and vibration damping tram tracks.

During the design process the dynamic loads of trams and buses were taken into account, then the load-bearing capacity, serviceability and fatigue limits were checked in accordance with Eurocode (Eurocode, 2004). Finite element analysis was made on the basis of the recorded material model recommended by RILEM TC 162-TDF (Vandewalle, et al. 2002). According to the calculations the tramway met the standard loads and load combinations.

### Tramlines around the world

The Szeged tramway project was a huge success. After the system proved to be fully functional several other tram tracks were constructed using very similar solutions and using macro synthetic fibres. These tram tracks were constructed in St. Petersburg, Russia, and in Tallinn, Estonia. In Hungary the success also continued and led to the partial reconstruction of Budapest tramlines Nr. 19 and Nr. 1, as well as the complete track reconstruction of the Nr. 3 tramline using this solution.

### Finite element analysis of the tramlines

Initially the finite element analysis of the tramlines was made by using Ansys finite element software. This software can handle the Rankine and Von-Misses combined failure criteria, which is a good approach for a fibre reinforced concrete material as the effect of the fibres is taken into consideration as a plastic model after the cracking (after yield point). Although because of the plastic material model both the crack propagation and the crack width of the concrete cannot be properly determined.

Due to this only a concrete specific finite element software should be use for the design and optimisation of fibre reinforced concrete tramlines. The two most well-known softwares are the ATENA and the DiANA. In our design ATENA software was used. ATENA uses Menétrey-William and Rankine combined fracture-plastic failure

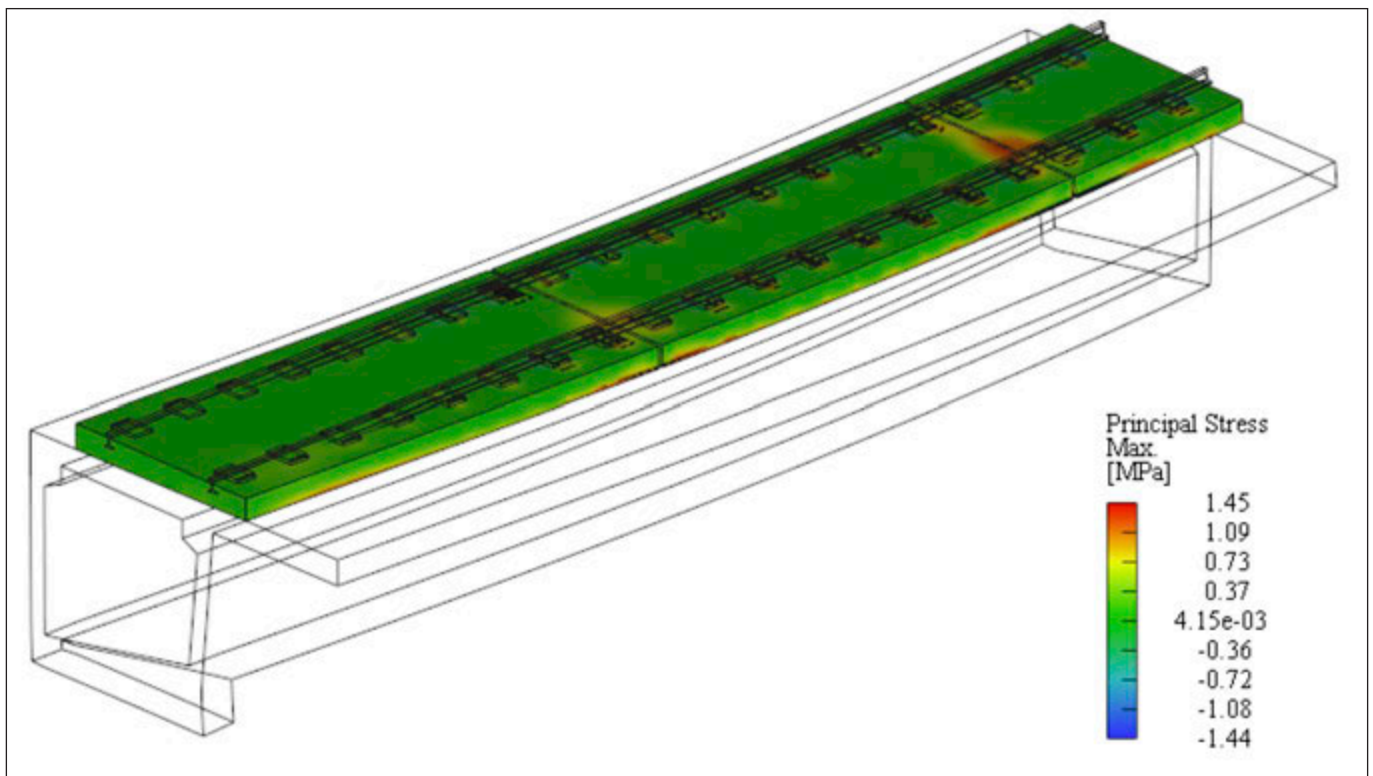

**Figure 3:** Tramline on a viaduct calculation with ATENA

surface (Rankine cube is at the tension side) (Cervenka and Papanikolaou, 2008). Tension is handled by a fracture model, based on the classic orthotropic smeared crack formulation and the crack band approach. It uses the Rankine cube failure criterion and it can be used as a rotated or a fixed crack model. The plasticity model for concrete in compression uses the William-Menétrey failure surface (Menétrey and William, 1995). Changing aggregate interlock is taken into account by a reduction of the shear modulus with growing strain, along the crack plane, according to the law derived by Kolmar (Kolmar, 1986). The model showed that the concrete met the stress-strain diagram criteria according to Eurocode 2 (Eurocode, 2004). The crack width was calculated from the stress-crack width diagram determined by means of inverse analysis with the help of the characteristic length which is a function of the size of the element and the angle of the crack within the element. This method is the only method that could realistically represent the cracks in a quasi-brittle material which is the main advantage of this advanced material model.

However, it is important to note that these models only define the peak strength of the material and not the post-cracking response. Numerous other models can be used to

approximate the post-cracking capacity of FRC such as the Modified Fracture Energy Method (Juhász, 2013) presented in the ITAtch guideline (ITAtch Activity Group Support, 2015) which was used here.

When stresses exceed the tensile strength of the concrete it will crack. There will be residual stress at the crack surface that is dependent on the crack width opening distance. This stress is associated with an energy, called fracture energy ( $G_F$ ) (fig 4a). Fibres increase this fracture energy ( $G_{FF}$ ) (fig 4b.), thereby making the concrete a more ductile material. The most important criterion for the selection of the FRC material model is to be able to model this increased fracture energy ( $G_{F,FRC}$ ) and select a value that is appropriate to the FRC used for a design (see Figure 4).

### 3. PRECAST CONCRETE TRAMLINES

Another important trend in tramline structures is the precast concrete track slabs. These elements are made in precast concrete factories and transported to site. These elements will be subjected to other loads beside above their

**Figure 4:** a) Fracture energy of FRC b) Tensile function used in the calculations

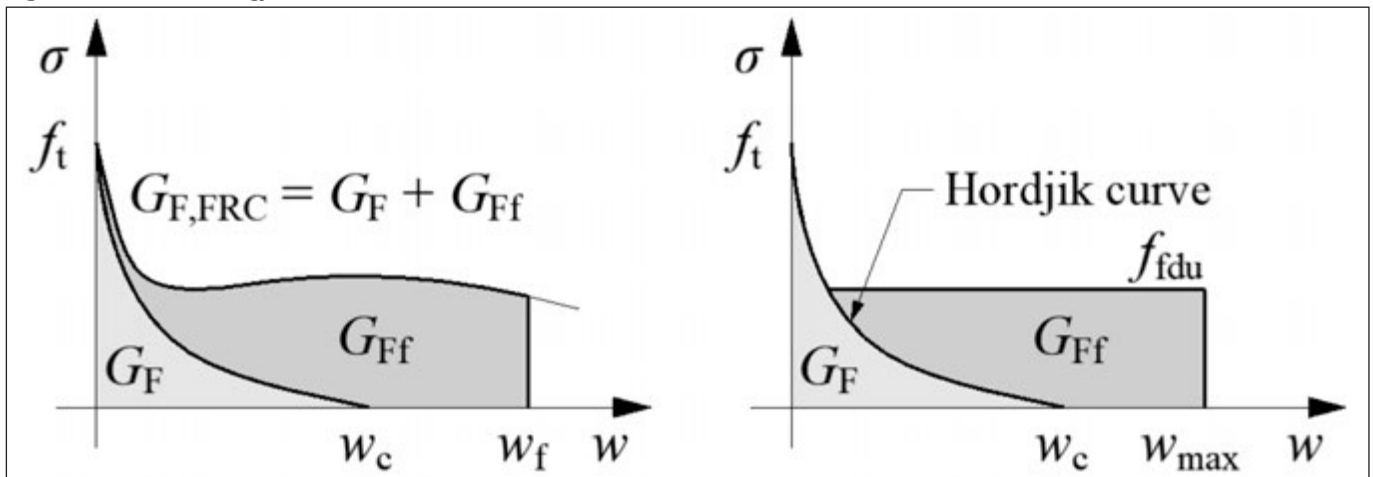

final load cases such as early age demoulding, rotation, lifting, stacking, transporting and installation on site. Usually these elements are made from concrete with higher strengths i.e. from C40/50 than the cast in place slabs i.e. from C25/30. Generally the precast elements have a higher dosage of macro synthetic fibre to the track slabs that are cast in place.

## The PCAT system

PreCast Advanced Track's (PCAT) unique 100 per cent macro synthetic fibre reinforced precast concrete slab structure is set to revolutionise the construction and repair of the world's railways (Hammond, 2016). PCAT's innovative lightweight slab structure represents a world first for precast track slabs as it is manufactured entirely from macro synthetic fibre reinforced concrete without steel reinforcement being required. This ensures that if the concrete cracks there is no steel to corrode providing a long life structure, as fibres continue right to the edge of the structure and so enhances durability and resistance to accidental damage. It also reduces maintenance, material costs and the fibre reinforcement is safer to handle than steel during manufacture. The PCAT slab design is based on a channel beam upper profile which provides a high modulus slab structure which maximising the slab's strength and minimises the stiffness needed for the track foundation. This allows PCAT tracks to be constructed quicker than conventional track.

The slabs connect to each other with a dry male - female joint for initial alignment and then with curved bolt connections. This is designed to permit the rapid laying and joining process to form the monolithic structure. Curved steel connectors between adjacent units are easily inserted and tensioned from the slab surface as erection proceeds. This allows rapid installation to take place from the newly laid track even in tunnels with restricted space. Uniquely, if needed, PCAT slabs can be simply decoupled, levels adjusted or slabs removed and replaced without affecting the rest of the track structure.

Two types of slabs were developed to serve all potential installation requirements. One is aforementioned standard slab (off-street slab) with the side beams which is highly optimised and can easily installed. The other one is a more

robust structure but with a straight upper surface and with hidden rails (on-street slab). This type of the slab can be used in streets and thanks to the sunken rails the traffic can easily cross the slab. The maximum length of both types is 5000 mm, the minimum thickness of the off-street slab is 150 mm and the thickness under the rails in case of on-street slab is 200 mm. The slabs were designed for 120 year lifetime.

## Finite element model of the structure

The numerical modelling of the PCAT slabs was done with ATENA finite element software. The finite element models of the structures can be seen in fig 5.

To ensure that the design model reflected the real structure's behaviour, all the details were modelled including the connection ducts, the injection holes, the rail sleepers and the rails with their exact geometry. A one and a one half slab was modelled to be able to investigate the behaviour of the joints. For the connecting surface an interface material was determined, which could only support compression stresses. During the loading process it was found that the slabs could open along the connection surface and the ducts bear the tension stresses. Under the slabs a bedding layer and a HBM (Hydraulically Bound Mixture) layer was modelled. For the subgrade non-linear springs were used. To investigate the effect of the soil parameters all the models were checked for a higher (350 MPa) and a lower (175 MPa) stiffness HBM layer.

In the model various material model configurations were used for the different structural elements. For the concrete slab the previously presented concrete material was used. For modelling the subbase and the subgrade linear elastic materials were used with different elastic moduli. The same material model was used for the sleepers as well. For the steel elements, such as the rails and connection cables a Von Mises material model was used which could handle the yield of the steel elements. Two different interface elements were used, one to model the friction between the concrete slab and the steel duct, and one to model the transfer of the compression forces between the two slabs. The parameters were determined in both cases to be as close to the real behaviour as possible.

To check all the possible effects on the slabs, different

**Figure 5:** Principal stresses and cracks in deformed ATENA model

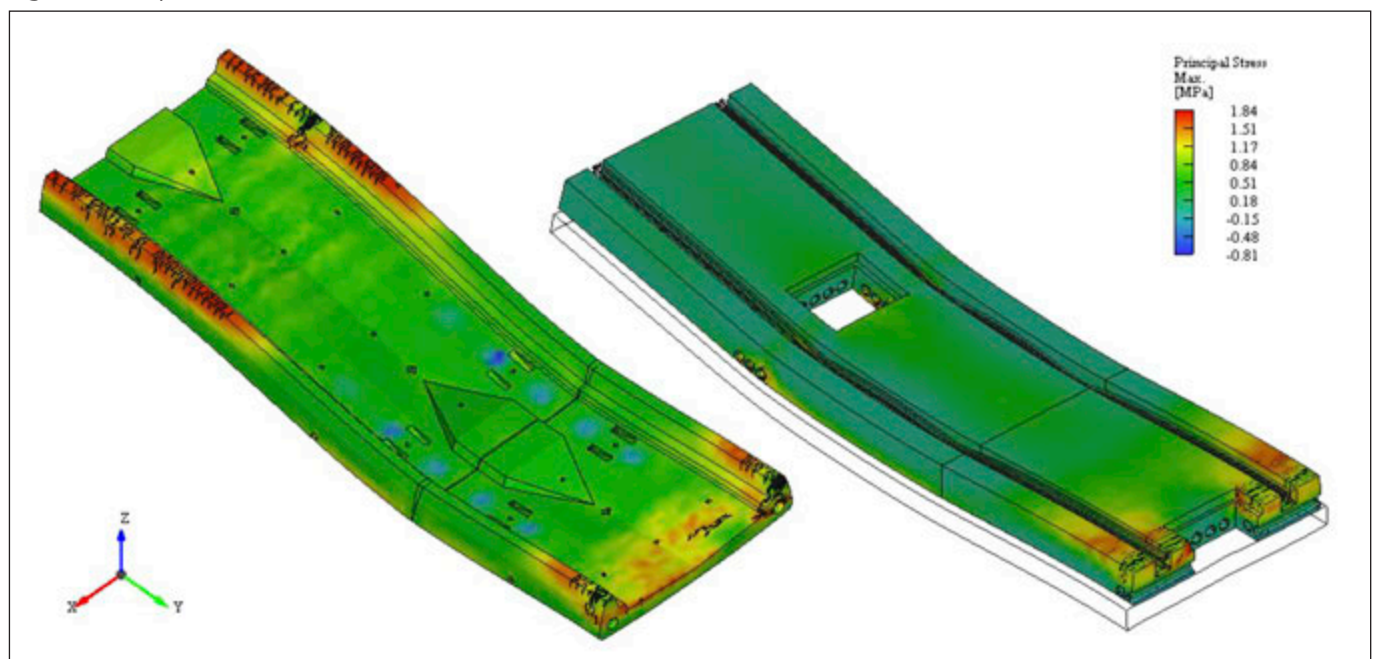

loading scenarios were carried out in the finite element software as its lifecycle the track slab will be subjected to various conditions. Because the slab is pre-casted the first loading will come from demoulding of the element. In this case a time dependent material model was used, which means the material parameters changed during the analysis following the hardening of the concrete. With this analysis the optimum demoulding time can be estimated as well. To the demoulding load a lifting and tearing force was added to the early age concrete slab. After this, but also in early ages, a rotation effect occurs: the demoulding was made upside down, but the racking of the precast slabs were in the other direction. In this two load case the lifting and rotating of the elements were also checked. The next situation was the storing load case. In this case the weight of three elements was added to the slab, simulating the effect of the stacking. The highlighted design target was to check the ultimate and serviceability limit states under the train's load and thus the geometry of the trains were added. To examine the worst loading case, and to model the passage of the train, seven different loading scenarios were carried out in different positions. In the Ultimate Limit State (ULS) the principal stresses were checked and in the Serviceability Limit State (SLS) the crack widths and the vertical displacements were checked. During the calculation the unequal rail loading was also taken into consideration. To be able to calculate the effect of the cyclic loading fatigue analysis was done also for all the loading positions. The number of the cycles was calculated back from the estimated lifetime of the structure and the average daily traffic. The finite element software calculated two additional fatigue strains for the maximum fracturing strain (Pryl et al. 2010), one handled the tensile strength reduction during the cyclic load (according to the Wöhler curve), and the other takes into consideration the crack opening effect during the cyclic load.

The structure complied with all the design requirements both in ULS and in SLS. In ULS the target was that the structure resists the loads with the appropriate safety factors and with design material parameter values without the failure of the structure. In SLS the aim was that the crack widths should be less than the value according to Eurocode 2 (0.2 mm). Both design cases met the requirements in every loading position and design situation.

The slabs deformation was realistic and it followed the expectation under the different loads. The connection between the two slabs worked well. It also can be seen that the structure is highly optimized. In ULS several cracks appeared in the surface of the structure, but without failure, and in SLS almost no visible cracks appeared in the structure.

## Real scale test

The PCAT slab was installed within their test pit to measure the actual deflection of the slab along the structure using an

**Figure 6:** The test line of the PCAT system



applied load at various locations. The position of the load was replicated the arrangement used in the FEM simulation. The PCAT off-street slab was designed for 12 tonne axle loads. For the testing it was proposed, after the first suite of loading at 8 tonne that the load be increased in 4 tonne increments up to 24 tonne, subject to slab performance during the test.

The loading of the slab was carried out using the Rail Trackform Stiffness Tester (RTST) (fig. 7) which was developed by AECOM to replicate the loading requirements of high-speed or heavy-haul lines through the use of an increased range of pulse-loading conditions. The RTST apparatus is mounted on a transport frame that can be moved along on rubber-caterpillar tracks whilst off track and then switched to rail wheels. On ballasted track geophones measure the deflection response of the ballast, sub-ballast, formation and subgrade enabling assessment of layer stiffness. During testing of the PCAT slab an array of 9 geophones were positioned above the concrete slab surface to record the deflection in microns.

To ensure the numerical model's property, a finite element analysis was calculated for the RTST test. The model contained the whole test setup including: the concrete pit, the compacted soil, and the two slabs with the previously mentioned detail. The effect of the RTST was added to the slab with using a steel plate which corresponds to the loading beam's foot. The measured value in the finite element model was the vertical deflection. It was measured at 9 different points replicating where the geophones were positioned for the actual test. The position of the loading plate in the finite element model followed the RTST machines position in the test.

The results in every loading case were close to each other. The finite element analysis closely mirrored what happened in reality and the differences between the measured deflections in the model and in the test was less than 0.1 mm. Only one loading scenario was where the difference was higher than modelled and this was where the load was positioned over the female joint. This was outlined in the AECOM report which determined very poor subgrade stiffness in this area. The results of the test and the FEA can be seen in fig. 8.

## 4. CONCLUSION

The use of macro synthetic fibre reinforced concrete has become more and more popular in the building industry and thus also in the concrete track slab constructions. Track slab structures are typically heavily exposed to weather and mechanical loads, and because of this must have sufficient ductility and durability. At the same time the repair or replacement of these elements is difficult as generally the traffic must be stopped for a long periods during this process. Based on these criteria the use of macro synthetic fibre is a good alternative reinforcement to mesh and steel bars. The concrete reinforced with the already mixed in corrosion-free

**Figure 7:** The RTST testing (AECOM PCAT Test report)





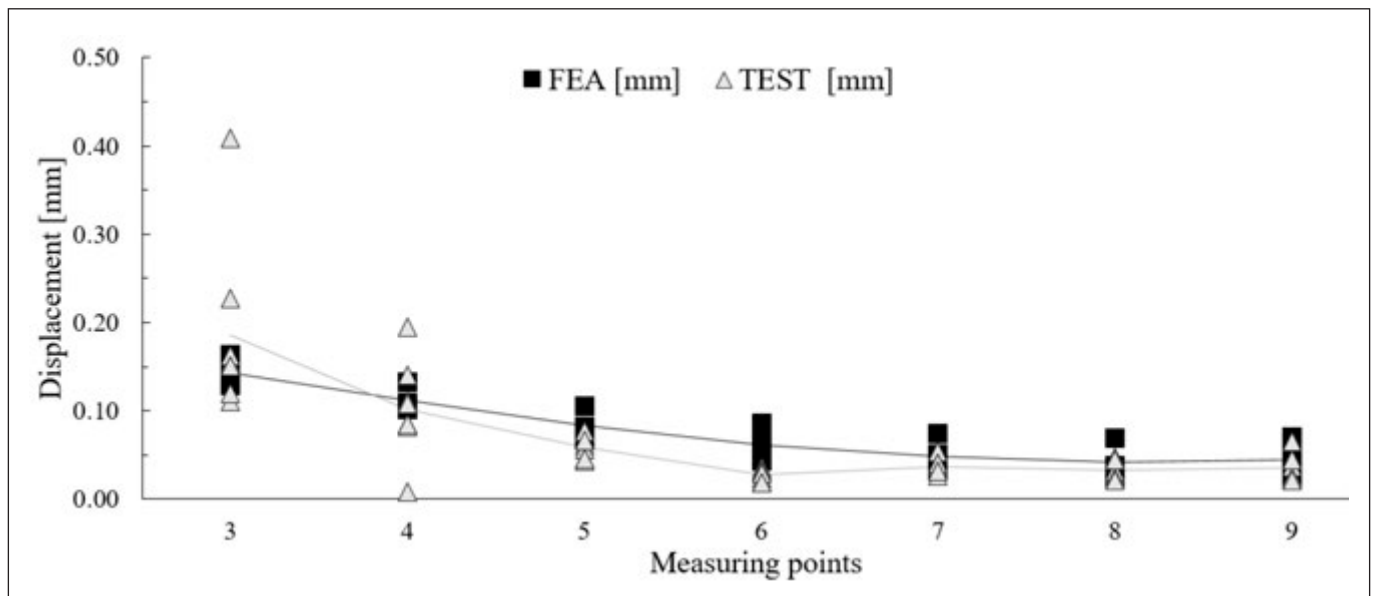

**Figure 8:** Results of RTST and FEA

fibres is easy to handle and the track slab can be constructed faster, thus by using FRC, labour can be decreased and the ductility increased. Further macro synthetic fibres are better for dynamic loads also, which is a significant advantage of this type of construction.

Design and optimizing of the track slab means the determining of the required thickness of the track slab and the macro synthetic fibre dosage for the varying load cases, such as ultimate and serviceability limit state, and fatigue. For these special tasks advanced finite element software is needed. The influence of the fibres could be taken into account by the modification of the fracture energy of the plain concrete. These design models have been validated by full scale laboratory tests.

## 5. REFERENCES

- Cervenka, J., Papanikolaou, V. K. (2008), *Three dimensional combined fracture-plastic material model for concrete*, International Journal of Plasticity (24) pp. 2192-2220. <https://doi.org/10.1016/j.ijplas.2008.01.004>
- Eurocode EN 1992 (2004), *European Code for design of concrete structures: European Committee for Standardization*, Brussels.
- Hammond, J. (2016), *Construction and Reinforcement*, Railing Professional October 2016 Issue, pp. 162-163.
- ITAtch Activity Group Support 2015, (2015), *ITAtch Design Guidance For Precast Fibre Reinforced Concrete Segments*, ITAtch Report n7, draft.
- Juhász, K. P. (2013), *Modified fracture energy method for fibre reinforced concrete*, Fibre Concrete 2013: Technology, Design, Application, pp. 89-90.

- Kolmar, W. (1986), *Beschreibung der Kraftübertragung über Risse in nichtlinearen Finite-Element-Berechnungen von Stahlbetontragwerken*, Dissertation, T.H. Darmstadt.
- Menétrey, P., William, K. J. (1995), *Triaxial Failure Criterion for Concrete and Its Generalization*, ACI Structural Journal, 92(3), pp. 311-318.
- Nagy, J., Juhász, K. P., Mészáros, A. (2014), *The beginning: the tramway in Szeged*, Innoteka, 2014 September, pp. 24-25.
- Nagy J., Juhász K. P., Herman S., Herman K. (2015a), *Az első magyar műanyag szállal erősített és fűvesített villamospálya 1. rész (The first Hungarian synthetic fibre reinforced and grassed tramline 1<sup>st</sup> part)*, Sínek világa, 2015/2, pp. 18-21.
- Nagy J., Juhász K. P., Herman S., Herman K. (2015b), *Az első magyar műanyag szállal erősített és fűvesített villamospálya 2. rész (The first Hungarian synthetic fibre reinforced and grassed tramline 2<sup>nd</sup> part)*, Sínek világa, 2015/3, pp. 10-14.
- Ridout, A. (2009), *Macro-fibre-reinforced concrete slab track*, Concrete, September 2009, pp. 16-18.
- Vandewalle, L., et al. (2002), *RILEM TC 162-TDF: Test and design methods for steel fibre reinforced concrete*, Materials and Structures, Vol. 33, J

**Károly Péter Juhász (1980)**, Structural Engineer MSc., Head of the Czakó Adolf Laboratory, Department of Mechanics, Materials & Structures, Budapest University of Technology and Economics. His main fields of activities are experimental investigation and modelling of synthetic fibre reinforced concrete, finite element modelling of concrete structures. Owner and chief engineer of JKP Static Ltd. Member of the *fib* working group 2.4.2.

**Péter Schaul (1989)**, Civil Engineer MSc., PhD student (Department of Construction Materials and Technologies, Budapest University of Technology and Economics). His main fields of activities are experimental investigation and modelling of FRC and FRP structures, finite element modelling of concrete structures. Structural engineer at JKP Static Ltd. Member of the *fib*.

# DIFFERENT PROPERTIES OF STEEL FIBRES REINFORCED CONCRETE-REVIEW ARTICLE



Abdelmelek Nabil – Éva Lublóy

DOI: 10.32970/CS.2018.1.2

*Properties of fibre reinforced concrete (FRC) are mainly influenced by type and amount of fibres. Practically, fibre properties are defined by the fibre producers. The mechanical behaviour of fibre reinforced concrete depends largely on the interactions between the fibres and the brittle concrete matrix: physical and chemical adhesion; friction; and mechanical anchorage induced by complex fibre geometry or by deformations or other treatments on the fibre surface. The mechanical performance of steel fibre reinforced concrete (SFRC) is also highly influenced by the fibre dispersion, since the effectiveness of fibre reinforcement depends on the orientation and arrangement of the fibres within the cement matrix, in which, short and randomly distributed steel fibres are often used for concrete reinforcement since they offer resistance to crack initiation and, mainly, to crack propagation.*

*In present paper we intended to give an overview of different parameters and their influence on the behaviour of SFRC.*

**Keywords:** FRC, steel fibres, SFRC, mixing time

## 1. INTRODUCTION

Fibre reinforced concrete (FRC) is concrete reinforced with more or less randomly distributed fibres. In FRC, thousands of small fibres are dispersed and distributed randomly in the concrete during mixing, and thus improve concrete properties in all directions (Amit Rana, 2013).

Favourable experiences with fibre reinforced concrete (FRC) resulted in its increasing application. Fibres are used to improve properties of fresh or hardened concrete, respectively. Toughness and residual strength after cracking of concrete can be significantly increased by application of fibres. Nowadays residual tensile strength of FRC is one of the most important parameter both for design and for practice (Erdélyi, 1993). The mechanical properties of FRC depend on the material properties of fibres (e.g. strength, stiffness), fibre geometry and surface, amount of fibres matrix properties (e.g. strength, stiffness, Poisson's ratio), interface properties (adhesion, frictional and mechanical bond) and loading condition (Naaman, Najm, 1991; Kim, Naaman El-Tawil, 2008; Aydm, 2013; Felekoglu, 2014). Testing and modelling of bond behaviour of fibres are important to realize the characteristic of FRC (Kovács, Balázs, 2003, 2004; Zhao, Verstryngge, di Prisco, Vandevallé, 2012; Balázs, 2012; Halvax, Lubloy 2013-1; Halvax, Lublóy, 2013; Zile, Zile, 2013; Breitenbucher, Me-schke, Song. Zhan, 2014).

## 2. STEEL FIBRES

Steel fibres are defined as short, discrete lengths of steel that having an aspect ratio (ratio of length to diameter) from about 20 to 100. The classification according to American Society for Testing and Materials (ASTM) A 820 divided

this materials into four general types of steel fibres which known as cold-drawn wire, cut sheet, melt extracted and other fibres based on the product used in their manufacture. The steel fibres have many types based on surface roughness and shape such as copped, hooked ends, crimped and wavy (ACI Committee 1996). Typical equivalent diameter of steel fibres ranges from 0.15 mm to 2 mm and length from 6 mm to 76 mm. The tensile strength of steel fibre goes up to 2 Giga Pascal (GPa) and modulus of elasticity to 200 GPa (ACI Committee, 1996; Hannant, 1978). The performance of steel fibres is influenced by many factors such as shape, fibre content and aspect ratio. The fibre with deformed shape or hooked end see (fig. 1) usually behaves better than straight ones due to better bond with concrete (Syed, 2012).

From other hand, the behaviour of SFRC can be classified into three groups according to its application, fibre volume percentage and fibre effectiveness. For instance SFRC is classified based on its fibre volume percentage as follows: 1-Very low volume fraction of SFs (less than 1% per volume of con-

**Fig. 1:** Hooked-end Steel Fibres (Marcelo, 2017)

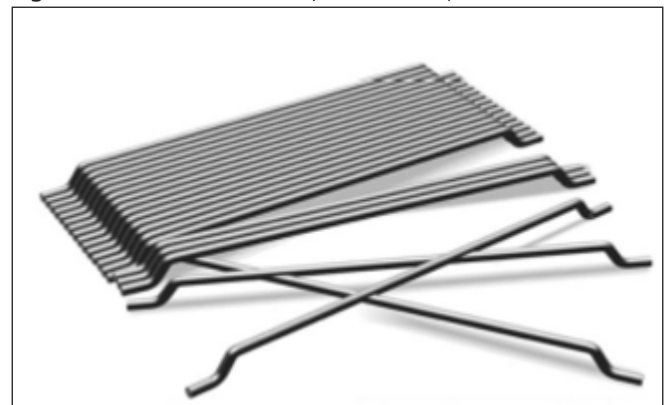

crete), which has been used for many years to control plastic shrinkage and as pavement reinforcement. 2- Moderate volume fraction of SFs (1% to 2% per volume of concrete) which can improve modulus of rupture (MOR), flexural toughness, impact resistance and other desirable mechanical properties of concrete. 3-High volume fraction of SFs (more than 2% per volume of concrete) used for special applications such as impact and blast resistance structure; these include SIFCON (Slurry Infiltrated Fibre Concrete), SIMCON (Slurry Infiltrated Mat Concrete; *Hamid, 2011*).

### 3. PHYSICAL PROPERTIES IN FRESH CONCRETE

The use of fibres is known to affect the workability and the flow characteristics of plain concrete essentially. Many researchers investigated the effect of the aspect ratio and volume content on the flow ability of concrete (*Noor et al., 2006*). Strictly speaking, the higher the aspect ratio is, the fewer fibres could be included to surpass the critical fibre content. For the same fibre content, better workability is achieved at lower aspect ratios (*Kareem and Narayanan, 1983*).

### 4. MECHANICAL PROPERTIES

#### 4.1 The effect of steel fibre on compressive, splitting tensile and flexural strength of concrete

The compressive strength test is considered the most suitable method of evaluating the behaviour of SFRC for underground construction at an early age, because in many cases (such as in tunnels) SFRC is mainly subjected to compression (*Ding, Wolfgang, 2000*). However, many researchers believed that steel fibres do not have the significant influence on the compressive behaviour of concrete due to the small volume of fibres in concrete mix (*Armelin, Helene, 1995*). In general, the effect of addition of steel fibres on compressive strength ranges from negligible to marginal and sometimes up to 25% as reported by (*Balaguru, Shah, 1992*).

Nagarkar et al. (1987) indicated that the compressive strength, splitting tensile and flexural strengths increase with increasing fibres content. The compressive, splitting tensile and flexural strength increased by 13-40% for fibrous concrete containing steel fibres with aspect ratio of 105 at 0.5% volume fraction. Dawood and Ramli (2010) had investigated the effect of steel fibre content with different percentages of steel fibre from (0-2%) on the flowable mortar. The results indicated that the compressive strength has increased by 21% as the steel fibre fractions was 1.25%. On the other hand, the flexural strength results recorded a significant increase of about 200% by the inclusion of steel fibre up to 1.75%. These results according to the authors are related to the improvement of mechanical bond between the cement paste and the steel fibres when the flow of mortar is adequately applied.

#### 4.2 The effect of steel fibre on toughness and impact capacity of concrete

Nataraja et al. (1999), Banthia, Sapp (2007) and Dawood, Ramli (2009) studied the affect of steel fibres on toughness. It

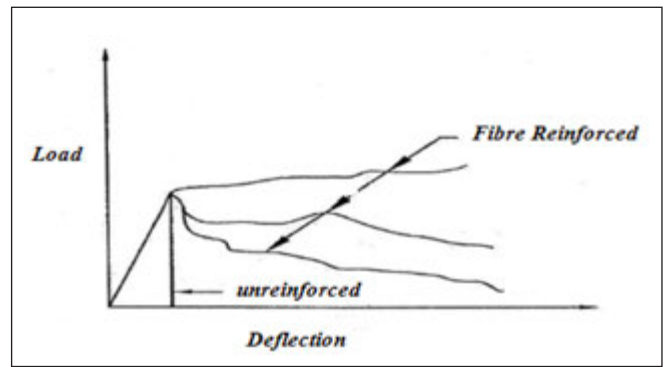

**Fig. 2:** Load-Deflection Curves for Plain and Fibrous Concrete (*ACI 544.1R, 1996*)

can be observed that the toughness improves with the increasing content of fibres, the reason being the ability of fibres in arresting cracks at both micro-and macro-levels. At micro-level, fibres inhibit the initiation of cracks, while at macro-cracks; fibres provide effective bridging and impart sources of toughness and ductility.

### 5. SFRC BENEFITS AND APPLICATIONS

The beneficial influence of SFs in concrete depends on many factors such as type, shape, length, cross section, strength, fibre content; SFs bond strength, matrix strength, mix design, and mixing of concrete. Typical load-deflection curves for plain concrete and FRC are shown in *Fig. 2 (ACI 544.1R, 1996)*. The addition of SFs in the conventional reinforced concrete (RC) members has several advantages such as 1- SFs increase the tensile strength of the matrix, thereby improving the flexural strength of the concrete. 2- The crack bridging mechanism of SFs and their tendency to redistribute stresses evenly throughout the matrix contribute to the post-cracking strength and restraining of the cracks in the concrete. 3- Increase ductility of the concrete. 4- SFRC is more durable and serviceable than conventional RC (*Rapoport et al., 2001; Grzybowski and Shah, 1990; Grzybowski 1989*). 4- Steel fibres reduce the permeability and water migration in concrete, which ensures protection of concrete due to the ill effects of moisture (*Amit Rana, 2013*).

The disadvantages of fibre-reinforced concrete are the reduced workability and the possibility of corrosion stains if the fibres are exposed at the surface “in case of steel fibres (*ACI 546R-04; Fowler, 2009*).

Nowadays, SFRC is used at an increasing rate in various applications such as the followings. Highway and air-field pavements, Hydraulic Structures, Fibre Shotcrete, Refractory Concrete, Precast Application, Structural Applications.

### 6. FIBRE PULL-OUT TEST

Many studies have been conducted to investigate the bond behaviour of steel fibre embedded in concrete, it can be seen that several researchers have focused on using pull-out test (*Fig. 3*). But only focusing on the bond behaviour of a single fibre (*Di Francia, 1996*).

The studies referred to in the next sentences reveal that there are several parameters that can influence the pull-out behaviour, namely: the adoption of hooks at the ends of the fi-

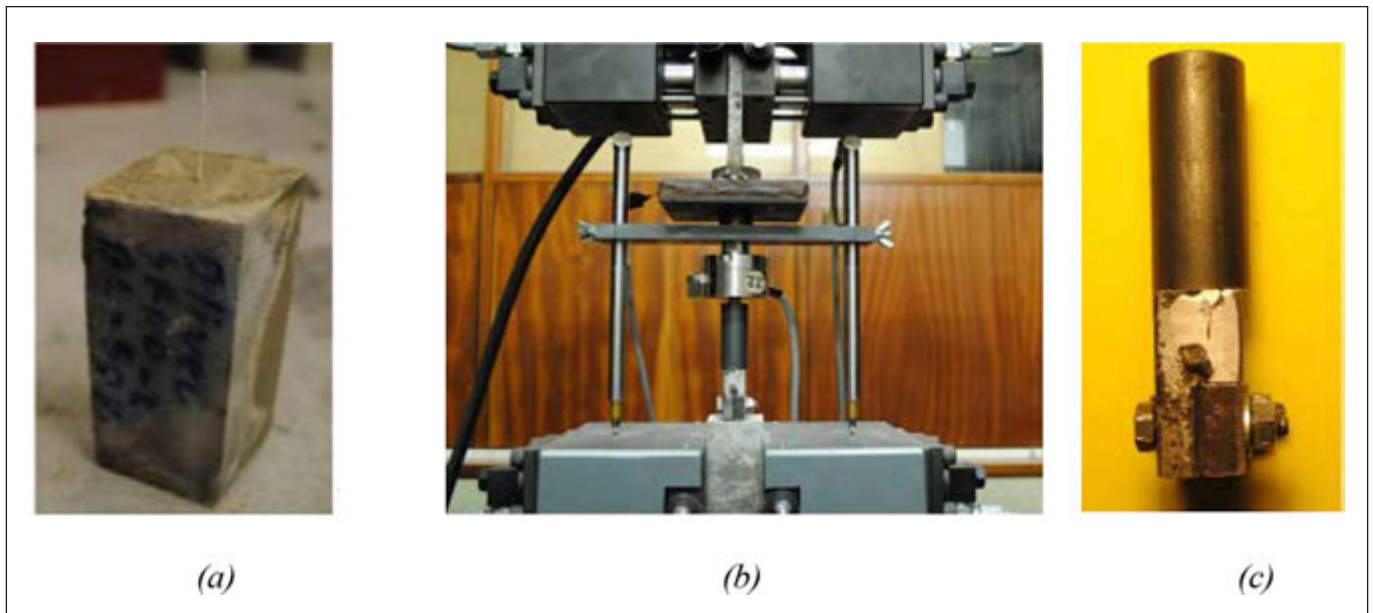

**Fig. 3:** Single fibre pull-out tests, a) test sample, b) test setup and c) the clamping mechanism (Lerch, 2018)

bre, the geometry of the hooks, the orientation and embedded length of the fibre, fibres and the mechanical properties of the matrix, the amount of fibres and the loading rate (Balázs, Polgár, 1999; Kovács, Balázs, 2003). Consequently, almost all properties of SFRC changes with the changing of the surface and the shape of fibres. Currently, the most widely used fibres in structural concrete industry, in terms of configuration, are either smooth or with hooks at the ends. The choice between these two types of fibres depends on the desired behaviour of the FRC (Bentur, 2007).

The appropriate fibre length is very important for effective usages of fibres. If the fibre lengths are too short the fibres will pull out from the mixture and the whole load bearing capacity of the fibres cannot be utilized (Fig. 4).

## 7. PARAMETERS INFLUENCING SFRC

### 7.1 Effect of mixing time

Manufacturers of the fibres have not determined the maximum allowed mixing time after addition of fibres to concrete so far. A lot of tests indicated different changes of fibre properties due to mixing. Different ways of mechanical deterioration was observed depending on the material, production technology, coating, size and surface of fibres. It is an important question whether the properties of fibres are significantly influenced by the longer mixing time than the minimum or not. (Czoboly and Balázs, 2016)

Czoboly and Balázs (2016) state that no significant change of properties of fibres in case of non-coated steel fibre caused by mixing in concrete. Shape deformation was observed for

**Fig. 4:** Tensile stress of the fibres with different lengths ( $l_c$  - critical length=fibre length at which the fibre first breaks instead of being pulled out) (Kelly, 1973)

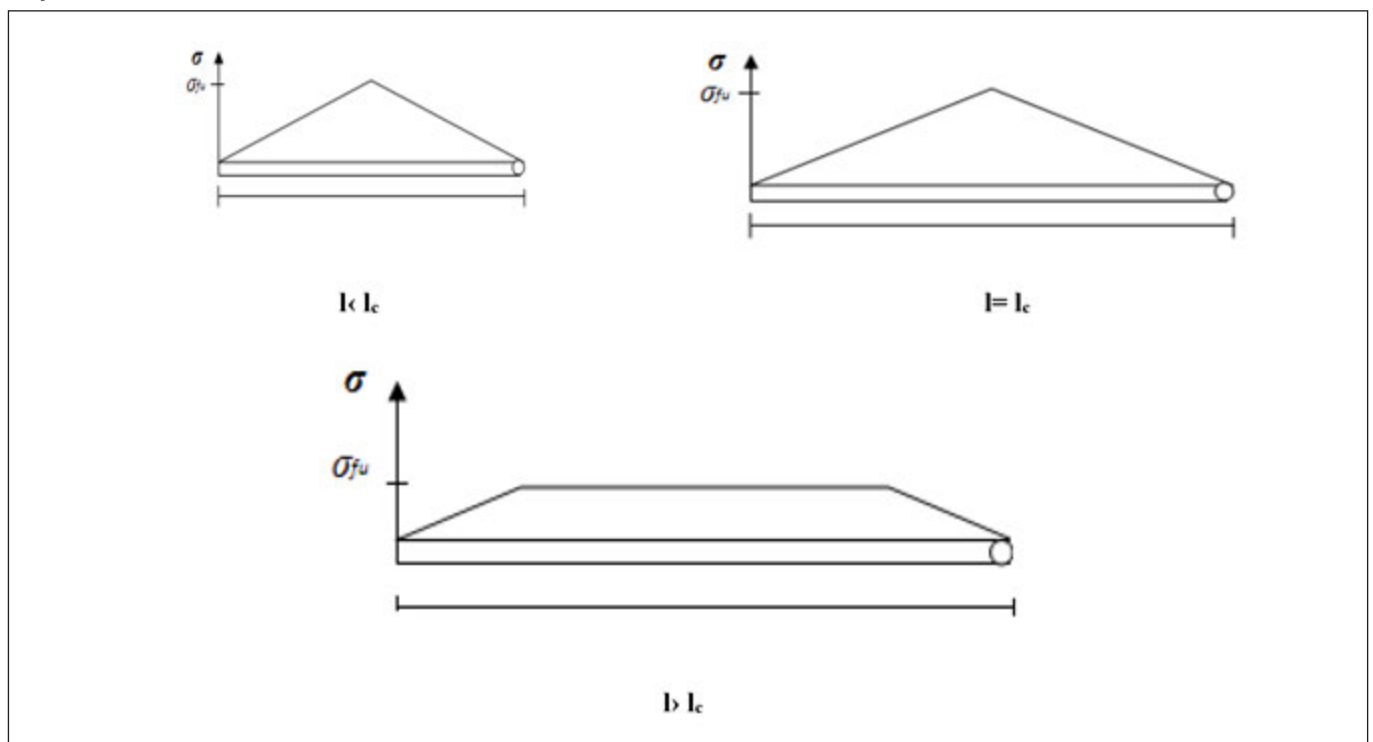

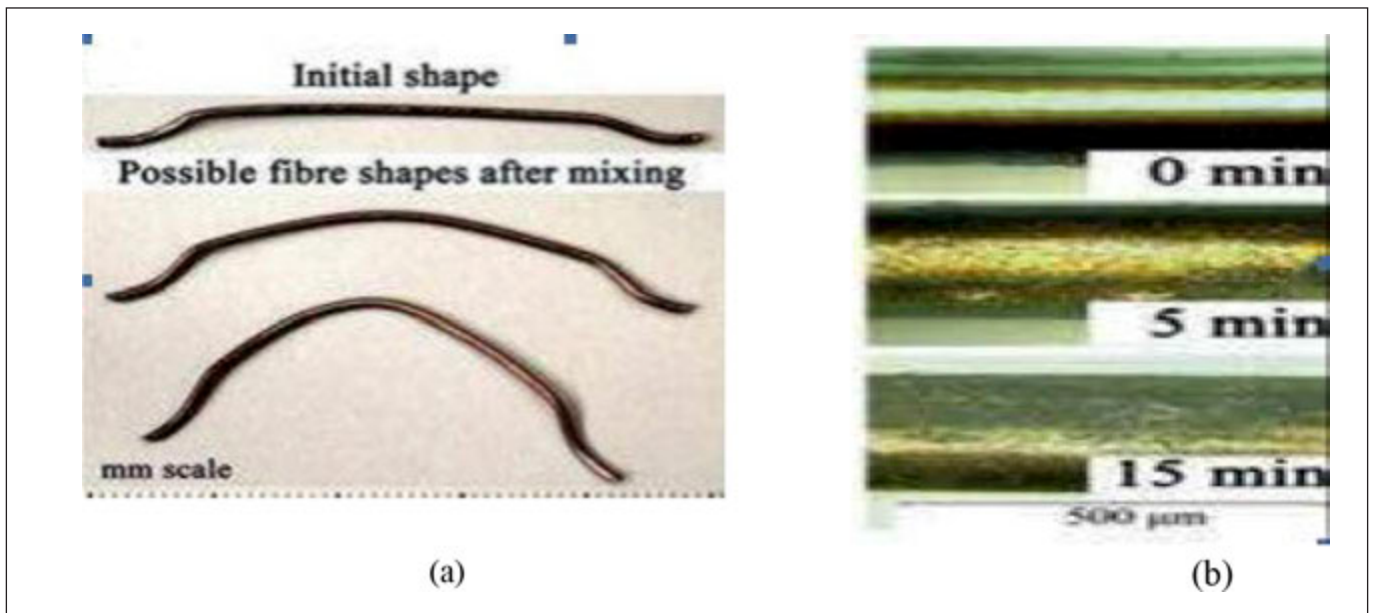

**Fig. 5:** Deterioration Modes of steel fibres, a) shape deformation, b) abrasion of coating of steel fibre (Czoboly and Balázs, 2016)

some fibres during mixing. The shape deformation probably does not significantly influence the properties of FRC. Abrasion of coating and also shape deformation were observed in case of coated fibres during mixing.

Czoboly et al (2016) have studied pull out behaviour of steel fibre with initial shape and after shape deformation. The tests indicated that the deformation of steel fibres could be observed after 5 minutes long mixing in concrete and the number of deformed fibres and the degree of deformation slightly increased as mixing time increased (Fig. 5). Probably the shape deformation could slightly improve the anchorage capacity of steel fibres. The maximum pull out force was higher in case of fibres with shape deformation than in case of fibres with initial shape (Lerch, 2018).

## 7.2 Effect of mixer type

The mixer type has significant effect on the shape of the fibre and the deformation depends on the type of the fibre, length, geometry, and surface of the fibre.

For the tilting drum mixer, however, the mixing time is shown not to have a statistically significant influence on the performance of SFRC. It is clear that the drum mixer does not damage the fibres beyond a point where the performance is negatively influenced. It is believed that a tilting drum mixer represents a typical ready-mix truck, which should therefore

not be a problem for macro synthetic fibre reinforced concrete. However, when pan mixers are used, e.g. in a precast factory, the mixing time should be no longer than what is needed to distribute the fibres evenly in the concrete. This is also only valid for this one type of fibre and it is recommended that every fibre type is checked that the performance is not negatively influenced before it is used (Lerch, 2018). The optimal mixing time depends on the mixer type (Fig. 6) as well as the type of fibre.

## 7.3 Effect of aggregate type

The influences of aggregate parameters on the properties of the SFRC, however, are generally not as well appreciated (Adkgenç, 2015), (Mehta P K, 2006), (Meddah, 2010). Since approximately 75% of the concrete volume is occupied by aggregates, it is known that the aggregate properties greatly affect the performance of the concrete.

The Surface deterioration was observed for coated steel fibres after mixing in concrete (Fig. 5-b). The amount of abraded fibres increased as the mixing time increased. According to the test results the ratio of deteriorated macro polymer fibres was higher after mixing in crushed recycled aggregate concrete compared to mixing in concrete with natural sand and gravel aggregates. It could be explained by the sharper surface of crushed recycled aggregate compared to the sur-

**Fig. 6:** a) Pan mixer and b) tilting-drum mixer (Lerch, 2018)



face of gravel aggregate, otherwise it's good for SFs in case of deformation (Czoboly and Balázs, 2016). So the type of aggregates have should be taken into account when we use some sensitive kind of fibres.

## 8. CONCLUSIONS

The inclusion of steel fibres in the concrete matrix leads to important changes in its behaviour, especially after cracking.

Main purpose of our study was to give an overview on the behaviour of steel fibre reinforced concrete especially the effect of key factors on the steel fibre and the anchorage between steel fibre/matrix interfaces. Thus different conclusions were drawn as follow:

- The homogeneous dispersion of the fibres is very important to achieve the best performance of FRC.
- The use of steel fibres according to many researchers may face drawback of inadequate workability or flow ability.
- Adding fibres into reinforced concrete in order to enhance the mechanical properties such as tensile and shear capacities of the structures has been thoroughly studied by several researchers.
- The manufacturers of the fibres should be specifying the duration of mixing after addition of fibres in concrete, taking into account the type of mixer.
- The compressive strength of the FRC specimens with steel fibres increases a mixing time increases. On the other hand the porosity of the SFRC decreases with the increase of the mixing time.
- Longer mixing times resulted in a slight increase of the post-cracking residual flexural strength of FRC beams containing steel fibres. The main reason for this was the increased compressive strength and increased number of the deformed steel fibres as the mixing time increased.
- Type of aggregate influences the surface of the fibre especially for the coated fibre. for instance mixing using crushed recycled aggregate concrete has more impact compared to mixing in concrete with natural sand and gravel aggregates

## 9. ACKNOWLEDGEMENTS

Authors acknowledge the support by the Hungarian Research Grant NVKP\_16-1-0019 "Development of concrete products with improved resistance to chemical corrosion, fire or freeze-thaw".

## 10. REFERENCES

ACI 544.1R. (1996), "State-of-the-Art Report on Fibre Reinforced Concrete", *American Concrete Institute*, Farmington Hills, Michigan.

ACI Committee. (1996), "State-of-the-Art Report on Fibre Reinforced Concrete", Detroit: Committee, A.C.I.-A., ACI 544.1 R-96.

Açıkgeçen, M. (2015), "A Graphic Based Approach for the Mix Design of Steel Fibre Reinforced Concrete", In: *Civil Engineering Department*, (Elazığ, Turkey: Firat University) pp: 186

Amit Rana (2013), "Some Studies on Steel Fibre Reinforced Concrete", *International Journal of Emerging Technology and Advanced Engineering*(ISSN 2250-2459, ISO 9001:2008 Certified Journal, Volume 3, Issue 1, January 2013).

Armelin, H.S. and Helene ,P., (1995), "Physical and mechanical properties of steel fibre reinforced dry-mix shotcrete", *ACI Mater. J.*, 92, pp: 258-287.

Balaguru, N. and Shah, S.P., (1992), "Fibre Reinforced Cement Composites", *McGraw-Hill*, New York, pp: 179-214.

Banthia, N. and Sappakittipakorn, M., (2007), "Toughness enhancement in steel fibre reinforced concrete through fibre hybridization",

*Cem. Conc. Res.*, 37, pp: 1388-1372. <https://doi.org/10.1016/j.cemconres.2007.05.005>

Bentur, A., Mindess, S., (2007), "Fibre reinforced cementitious composites", Taylor & Francis: 2007.

Breitenbücher, R., Meschke, G., Song, F., Zhan, Y. (2014), "Experimental, analytical and numerical analysis of the pullout behaviour of steel fibres considering different fibre types, inclinations and concrete strengths", *Structural Concrete*, Vol. 15, No. 1, pp: 126-135. <https://doi.org/10.1002/suco.201300058>

Czoboly, O., Balázs, L. Gy. (2016), "Influence of mixing time to the properties of steel fibres and steel fibres reinforced concrete", *Concrete Structures*, HU ISSN 2062-7904, Vol. 17., pp: 23-28., <http://www.fib.bme.hu/folyoirat/cs/cs2016.pdf>

Dawood, E.T. and Ramli, M., (2010), "Development of high strength flowable mortar with hybrid fibre". *Construction Building Mater*, 24: pp: 1043-1050. <https://doi.org/10.1016/j.conbuildmat.2009.11.013>

Dawood, E.T. and Ramli, M., (2009), "Use of flowable high strength mortar as a repair material for sustainable engineering construction", *Proceedings of 1st International Conference of Rehabilitation and Maintenance in Civil Engineering*, March 21-22, South Africa, pp: 289-278.

Di Francia, C., Ward, T. C., Claus, R.O., (1996), "The single-fibre pull-out test", 1: review and interpretation. *Compos. Part A Appl Sci Manuf* ;27:597e612.

[http://dx.doi.org/10.1016/1359-835X\(95\)00069E](http://dx.doi.org/10.1016/1359-835X(95)00069E).

Ding, Y. and Wolfgang, K., (2000), "Compressive Stress-strain relations ahip of steel fibre reinforced concrete at early age", *Cement Concrete Res.*, 30: pp: 1573-1579. [https://doi.org/10.1016/S0008-8846\(00\)00348-3](https://doi.org/10.1016/S0008-8846(00)00348-3)

Erdlyi, A., (1993), "The toughness of steel fibre reinforced concretes", *Periodica Polytechnica Civil Engineering*. Vol 37, No. 4, pp: 329-344.

European Norms, (2007), "Test method for metallic fibre concrete, Measuring the Flexural Tensile Strength", (Limit of Proportionality (LOP), Residual), EN 146512005 + A12007, 2007.

Felekoglu, B., (2014), "Effects of loading conditions and specimen thickness on the flexural behavior of fibre-reinforced cementitious composites", *Periodica Polytechnica Civil Engineering*. Vol. 58, No. 3. pp: 279 291 DOI: 10.3311/PPci.7486

Fowler, D.W., (2009), "Failure, Distress and Repair of Concrete Structures", *Woodhead Publishing Series in Civil and Structural Engineering 2009*, pp: 194-207

Grzybowski, M., (1989), "Determination of Crack Arresting Properties of Fibre Reinforced Cementitious Composites", Chapter 12, Royal Institute of Technology, Stockholm, Sweden.

Grzybowski, M. & Shah, S. P., (1990), "Shrinkage cracking of fibre reinforced concrete", *ACI Materials Journal*, 87.

Halvax, K., Lublőy, E., (2013-1), "Pull-out behaviour of steel fibres", *Fibre concrete 2013*, prague, Czech Republic, 12-13, 2013, pp: 1-10

Halvax K. Lublőy E. (2013-2), "investigation of steel fibres bond strength in mortar matrix", *Pollack Periodica*, Vol. 8. No. B, pp: 10t-110

Hamid, P., (2011), "Steel Fibre Reinforced Concrete: A Review", *Published at ICSECM 2011*, Kandy-SriLanka

Hannant, D., (1978), "Fibres cements and fibres concretes", *John Wiley & Sons, Inc.*, New York.

Kareem, A.S.P., and Narayanan, R., (1983), "Factors influencing the workability of steel fibre reinforced concrete: Part 2", *Concrete*, 17: 432-444.

Kim, D. J., Naaman A. E., El-Tawil, S., (2008), "Comparative flexural behavior of four fibre reinforced cementitious", *cement and concrete composites*, Vol. 30, No. 10, pp: 917-928. DOI 10.1016/j.cemconcomp.2008.08.002.

Kovács, L., Balázs, G. L., (2004), " Structural performance of steel fibre reinforced concrete", *Book, Publ. Comp. of Budapest University of Technology and Economics. 2004*. ISBN 963 410 s22 bme.hu/konyvck/steel-fibre-pdf

Kovács, L., Balázs, G. L., (2003), "Structural behaviour of steel fibre reinforced concrete", *Journal of structural Concrete*, 2003/2, pp: 57-63.

Lerch, J.O., Bester, H.L., Van Rooyen A.S., Combrinck, R, Villiers, W.I. de, Boshoff, W.P., (2018), "The effect of mixing on the performance of macro synthetic fibre reinforced concrete", *Cement and Concrete Research 103*, pp: 130-139. <https://doi.org/10.1016/j.cemconres.2017.10.010>

Di Prisco, M., Plizzari, G., Vandewalle, L., (2009), "Fibre reinforced concrete", *new design, Perspectives 42*, pp: 1261-1281.

Marcelo, S., M., J., (2017), "Evaluation of elastic properties of ultra high Performance concrete reinforced with steel fiber: Mean-field homogenization versus fe homogenization", *Cilamce, XXXVIII Iberian Latin-American Congress on Computational Methods in Engineering*, <https://www.researchgate.net/publication/323994109>

Moradi, M., Reza Esfahani, M., (2017), "Application of the strut-and-tie method for steel fibre reinforced concrete deep beams", *Constr. Build. Mater.* 131, pp: 423-437. <https://doi.org/10.1016/j.conbuildmat.2016.11.042>

Meddah, M. S., Zitouni, S., and Belâabes, S., (2010), "Effect of content and particle size distribution of coarse aggregate on the compressive strength of concrete", *Constr. Build. Mater.* 24 505-12. <https://doi.org/10.1016/j.conbuildmat.2009.10.009>

- Mehta, P. K., and Monteiro, P. J. M., (2006), "Concrete: Microstructure, Properties and Materials" (New York: McGraw-Hill)
- Naaman, A. E., Najm, H., (1991), "Bond-Slip Mechanism of Steel Fibres in Concrete", *ACI Materials Journal*, March-April 1991, pp: 135-145.
- Nagarkar, P.K., Tambe, S.K., and Pazare, D.G., (1987), "Study of fibre reinforced concrete". *Proceedings of the International Symposium of Fibre Reinforced Concrete*, Dec. 18-19, Madras, India, pp: 130-138.
- Nataraja, M.C., Dhang, N., and Gupta, A.P., (1999), "Stress-strain curves for steel fibre reinforced concrete under compression", *Cement Concrete Composite*, 21: pp: 383-390. [https://doi.org/10.1016/S0958-9465\(99\)00021-9](https://doi.org/10.1016/S0958-9465(99)00021-9)
- Noor, A.M., Salihudin, R.S., and Mahyuddin, R., (2008), "Performance of high workability slag-cement mortar for ferrocement", *Building Environ*, 42: pp: 2710-2717.
- Rapoport, J., Aldea, C., Shah, S. p., Ankenman, B., and Karr, A.F., (2001), "Permeability of Cracked Steel Fibre-Reinforced Concrete", Technical Report No.115, National Institute of Statistical Sciences (NISS), *Research Triangle Park, NC, USA*.
- Syed Mohsin, S.M., (2012), "Behaviour of fibre-reinforced concrete structures under seismic loading", Imperial College London.
- Torgal, F.P., Jalali. S., (2011), «in *Fibrous and Composite Materials for Civil Engineering Applications*»,
- Zhao, G., Verstryngge, E., di Prisco, M., Vandewalle, L., (2012), "Investigation on single fibre pullout and interfacial debonding mechanisms with acoustic emission techniques", *8th RILEM International Symposium Fibre Reinforced Concrete challenges and opportunities (BEFIB 2012)*, pp: 369-380.
- Zile, E., Zile, O., (2013), "Effect of the fibre geometry on the pullout response of mechanically deformed steel fibres", *Cement and Concrete Research*, Vol. 44, No. 1, pp: 18-24. <https://doi.org/10.1016/j.cemconres.2012.10.014>

**Abdelmelek Nabil** (1992), PhD student at the Department of Construction Materials and Technologies, Budapest University of Technology and Economics. His main fields of research interest are: fire design and behaviour of concrete at elevated temperature. Member of the Hungarian Group of *fib*. [abdelmelek.nabil@epito.bme.hu](mailto:abdelmelek.nabil@epito.bme.hu)

**Éva Lublóy** (1976), Dr.-habil, PhD, Senior lecturer in structural engineering, at the Budapest University of Technology and Economics. Her main fields of interest are: fire design, behaviour of constructions materials at elevated temperature. Member of the Hungarian Group of *fib*. [lubloy.eva@epito.bme.hu](mailto:lubloy.eva@epito.bme.hu)

# PRECAST CONCRETE HOLLOW CORE SLABS EXPOSED TO ELEVATED TEMPERATURES IN TERMS OF SHEAR DETERIORATIONS – REVIEW ARTICLE



Naser Alimrani – György L. Balázs

DOI: 10.32970/CS.2018.1.3

*Hollow core units were developed in the 1950s when long-line prestressing techniques evolved. Ever since then extensive studies followed concerning this particular field for concrete structures. Design methods of hollow core slabs have no requirements for transverse reinforcements which make it more prone to shear failure especially at elevated temperatures. It is understandable that the behaviour of hollow core slabs under elevated temperatures is more complex than that of solid slabs. The longitudinal wholes cause discontinuity in thermal transfer even though webs are effective parts transferring thermal loads to the unexposed parts of the structural element. Even if several influencing parameters have been investigated in order to evaluate their influence on different failure mechanisms of the hollow core slabs at elevated temperatures, still further efforts are needed. This paper presents a review for influencing parameters, failure modes and code provisions for hollow core slabs at elevated temperatures.*

**Keywords:** hollow core slabs, precast, prestressed, shear failure, elevated temperatures

## 1. INTRODUCTION

### 1.1 Preface

Hollow core (HC) slabs are generally precast prestressed concrete slabs made primarily for floor structures in buildings. HC slabs also have applications as both vertical and horizontal wall panels, spandrel members, and bridge deck slabs (PCI, 2015). Since 1950's, these flooring units have been widely used in Europe, USA and many countries all over the world. The width of the slabs are typically 1.2 m whereas depth of the slab depends on the desired span based on design restrictions. It generally ranges from 200 to 400 mm (Fig. 1).

HC slabs have no reinforcement other than the longitudinal prestressing wires or strands, anchored by bond. Subsequently it uses 30% less concrete and 50% less steel. As a result, HC slabs possess lower shear capacity as compared to traditional solid slabs (Fellinger, 2004). Therefore, HC slabs, unlike solid slabs in which failure is predominantly governed by flexural capacity, are susceptible to shear failure at both ambient and elevated temperatures (Rahman et al., 2012). Finally, the production of HC slabs causes almost no waste since all lost material is collected and reused as granulate in the same precast plant (Fellinger, 2004).

### 1.2 Manufacturing of hollow core slab elements

Seven major manufacturing systems of HC slab elements are available today. Because each production system is patented,

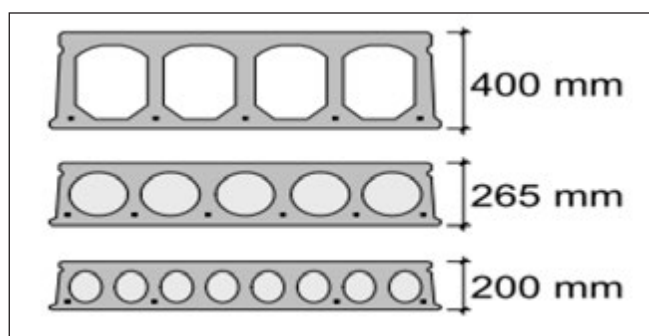

Fig. 1: Cross section of various HC elements (Fellinger, 2004)

producers are usually set up on a franchise or license basis using the background, knowledge, and expertise provided with the machine development. Each producer then has the technical support of a large network of associated producers (PCI, 2015).

However, two basic manufacturing methods are currently used for the production of hollow core slabs. The first is the dry-cast or extrusion system where a low-slump concrete is forced through the casting machine. The cores are formed with augers or tubes, and compaction and vibration are used to consolidate the concrete around the cores. The second is the wet-cast system which uses a normal slump concrete.

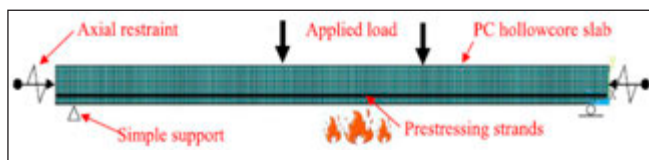

Fig. 2: Typical HC slab exposed to fire (Kodur and Shakya, 2017)





**Fig. 3:** Illustration for some of the steps of manufacturing HC slabs (Elematic, 2012)

In this system, the sides of the slabs are formed either with stationary, fixed forms, or with forms attached to the machine (when the sides are slip formed). The cores in the wet-cast systems are formed with either lightweight aggregate fed through tubes attached to the casting machine, pneumatic tubes anchored in a fixed form, or long tubes attached to the casting machine that slip form the cores (PCI, 2015).

In most cases, the hollow core slab elements are cast on long-line beds, normally 300 ft (~92 m) to 600 ft (~183 m) long (Fig. 3). After curing, the slab elements are sawcut to the appropriate length for the intended project (PCI, 2015).

## 2. INFLUENCE OF ELEVATED TEMPERATURES

### 2.1 Background

European and international building regulations require a minimum fire resistance for structures. Eurocode 1 (EN 1991-1-2:2002) defines fire resistance as: “The ability of a structure, a part of a structure or a member to fulfil its function (load bearing function and/or separating function) for a specified load level, for a specified fire exposure and for a specified period of time”. The fire resistance is assessed either by testing (both large and small scales) or by calculation. Generally, an assessment of the entire structure under fire

conditions is very complex and expensive experimentally although it is the likely method to obtain accurate data and results. Therefore, the fire resistance is mostly assessed on the basis of a member analysis, i.e. a single slab as shown in Fig. 2 separated from the rest of the structure.

Remarkable fire resistance tests on HC slabs were performed by Abrams (1976), Borgogno (1997), Schepper and Anderson (2000), Acker (2003), Fellingner (2004), Jensen (2005), Bailey and Lennon (2008), Venanzi et al, (2014) and Kodur and Shakya (2014, 2017). These fire tests were performed under standard fire conditions and subjected also to service loads. Some of them present numerical studies and modeling as well.

Most of the aforementioned fire tests were performed under standard fire exposure solely to develop fire-resistance ratings for tested precast, prestressed concrete HC slabs. Based on these fire tests, some of possible factors for failure were identified such as spalling, bond slip of prestressing tendons and shear. However, the effect of factors on fire resistance is not fully quantified. Therefore, reasons due to failure mechanisms of HC slabs are not well established yet (Kodur and Shakya, 2014).

### 2.2 Theory of thermal stresses

As pointed out in the introduction, the shear behaviour of HC slabs at elevated temperatures can be dominant in structural design. Furthermore, the shear behaviour can only be assessed taking into account the effect of thermal strains.

The *Thermal Strains* is strictly the strain of non-drying concrete measured when concrete is heated without applied load. It does not contain drying shrinkage (fib, 2007). It is worth to mention that *Transient Creep*, called sometimes Transient Strain or Transient Thermal Strain, is often confused with *Load Induced Thermal Strain (LITS)*. LITS is essentially measured by the difference between the strain measured during first heating without load and that measured during first heating under load. Whereas thermal creep is the largest component, in addition to basic creep and elastic strain, of the LITS. Fig. 4 (fib, 2007).

The thermal elongation of the exposed side of the slab will cause thermal stresses over the entire cross section of the HC slab. Thermal stresses result from mechanical strains that have to develop to counteract incompatible thermal strains in order

**Fig. 4:** Illustrations of thermal strain: (a) definition of the Load Induced Thermal Strain (LITS) and (b) LITS contains three main components (fib, 2007).

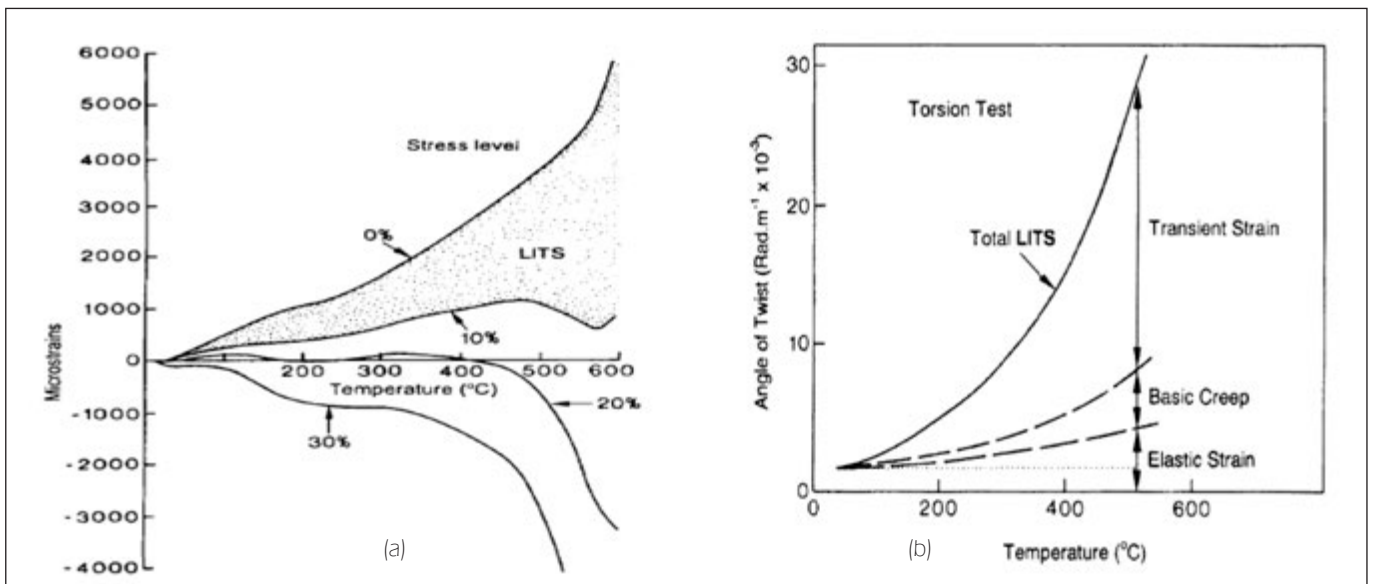

to meet the compatibility requirements. The thermal strains solely depend on the temperature rise and the coefficient of thermal expansion, which is a material's property. Due to the thermal expansion, axial forces and bending moments can develop by restraining boundaries. Even though HC slabs are in principle simply supported and the thermal expansion is not restrained, thermal stresses will develop within the cross section if the temperature distribution over the cross section is non-linearly distributed. The actual stress distribution has to satisfy the equilibrium conditions. Moreover, the actual constitutive behaviour of concrete and reinforcing steel shall be considered (fib, 2007).

The well-known theory of elasticity is no longer applicable due to the thermal strains and the highly non-linear stress-strain relationships for concrete and prestressing steel at elevated temperature (Fellinger, 2004). As a result, compressive thermal stresses will develop at the flange and tensile stresses at the web causes vertical cracks. Thus new state of equilibrium must be taken into consideration containing the developed normal force, the shear force and the bending moment.

### 3. CODE PROVISIONS

Eurocode 2 (EN 1991-2: 2004) presents requirements for fire design to determine the fire resistance of precast, prestressed concrete slabs. It provides three options i.e. tabular, simplified or advanced methods (Table 1). However, In case of hollow core slabs, additional rules are required (Jansze et al., 2012). These requirements were introduced in EN 1168 by the Eurocode which referred to the chapters 4.2, 4.3, and to Annex B in Eurocode (EN 1168, 2005). It is worth to mention that there are additional Annexes in Eurocode, D and E, for bending failure, and shear and anchorage failure (EN 1991-2: 2004).

**Table 1:** Alternative methods of verifications of fire resistance Eurocode 2 [EN 1991-2: 2004]

	Tabulated data	Simplified calculation methods	Advanced calculation methods
<i>Member analysis</i> The member is considered as isolated. Indirect fire actions are not considered	Yes	Yes	Yes
<i>Analysis of part of the structure</i> Indirect fire actions are considered, but no time-dependent interactions with other parts of the structure.	No	Yes	Yes
<i>Global structural analysis</i> Analysis of the entire structure is applied.	No	No	Yes

On the other hand, *Building Code Requirements for Structural*

*Concrete* (ACI 318-11) have references to *Code Requirements for Determining Fire Resistance of Concrete and Masonry Construction Assemblies* (ACI 216.1-07). The later gives prescriptive specifications for evaluating fire resistance ratings of concrete and masonry structures based on ASTM E11924 standard fire tests. ACI provisions for determining the fire resistance of precast, prestressed concrete slabs are also similar to provisions in the *PCI Design Handbook and the International Building Code*. ACI also specifies minimum slab and concrete cover thicknesses to achieve a required fire-resistance. Further, both *PCI Design Handbook* and *Design for Fire Resistance of Precast/Prestressed Concrete* provide a rational design methodology for evaluating the fire resistance of precast, prestressed concrete slabs based on strength degradation of strand with temperature.

Other design codes, such as Australian code AS 3600, New Zealand concrete standard NZS 3101 and the *National Building Code of Canada* include provisions similar to those of *PCI Design Handbook* and ACI 216.1-07 (Kodur and Shakya, 2014).

## 4. FAILURE MODES

### 4.1 At ambient temperature

Unlike ordinary slabs which are usually predominant by flexural failure, shear failure mode has been observed in several HC slabs tests (Rahman et. al, 2012). In fact, many of researchers have found that nominal shear stress at failure start to develop even before shear strength calculated by some design codes (Angelakos et al, 2001; Lubell et al, 2003; Dwairi et al, 2005).

Therefore, a reduction in web-shear strength from the capacity predicted by (ACI 318-05) seems warranted for HC members deeper than 320 mm (Hawkins and Ghosh, 2006). With such a reduction, web shear will control the design of deep HC sections more often. Walraven and Mecx (1983) noticed four principal failure modes in a large project containing several tests:

- a) **Pure flexural failure**  
Ductility of a slab after flexural cracking is considerable since the cross section of the steel is relatively small, developing fork-shape and reducing the compression area, however, failure generally occurs as a consequence of rupture of the prestressing steel (Fig. 5a).
- b) **Anchorage failure**  
If the crack pattern extends towards the support the length of the anchored strand may be too small to develop sufficient capacity thus, the concrete element is susceptible to strand-slip through the concrete (Fig. 5b).
- c) **Shear tension failure**  
In case the tensile strength in the webs becomes too high in the uncracked region in bending, an inclined crack occurs resulting in immediate failure. This region is generally where the influence of the vertical support stresses is exhausted (Fig. 5c).
- d) **Shear compression failure**  
Flexural cracks can develop into shear cracks. By increasing the load, subsequent failure can occur in the compression zone, by crushing or splitting (Fig. 5d).

### 4.2 At elevated temperatures

The four failure modes presented by Walraven and Mecx are extensively studied by Fellinger (2004). He compared it

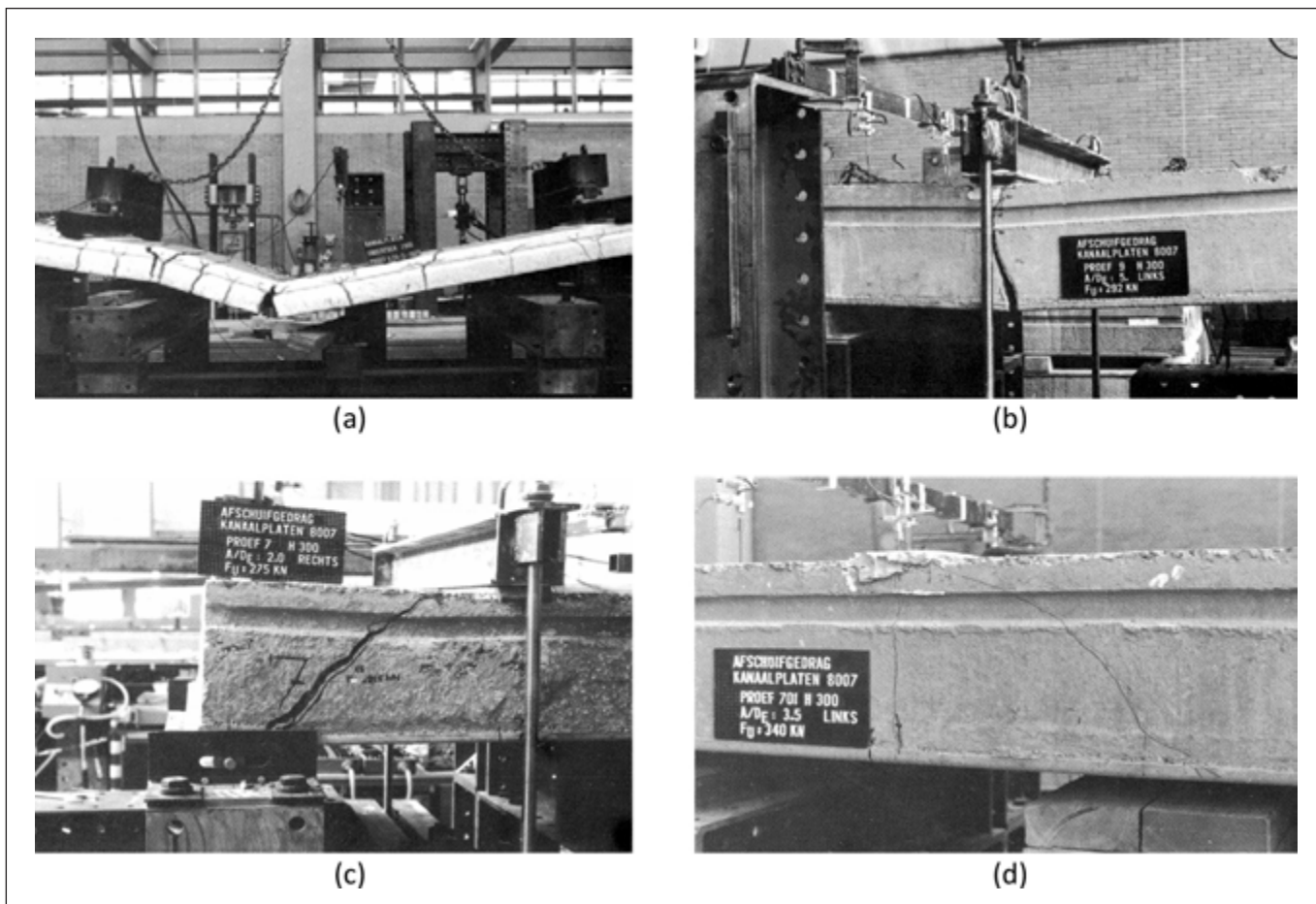

Fig. 5: Different types of failure modes in HC slabs (Walraven and Mecx, 1983) (Room temperature)

to his theoretical and experimental results. Concluding that the load bearing capacity of HC units on rigid supports can adequately be described by the theoretical formulations given before. He also proceeded to prove that all input parameters are considered in an appropriate manner for all four failure modes. Therefore, the theoretical formulations can be used in order to evaluate the load level in the fire tests found in literature. The results were as the following:

#### 4.2.1 Flexure

Due to prestress, the strands are tensioned and the concrete is in compression. Bending tensile stresses reduce the compressive stresses at the bottom to reach the tensile strength

of concrete. Then vertical cracks develop perpendicular to the tensile stress causing the so called flexural cracks from the bottom of the slab. The slabs have to be designed with sufficient strands such that the strands can undergo this stress increase without reaching the steel strength.

By increasing the load the tensile stress in the strand and the compressive stress in the concrete compression zone both increase. Since slabs are designed in such a way that the strand reaches the yield strength before the concrete compression zone crushes, rupture of the strands will occur after significant yielding and large deflection. (Fig. 6)

The bending moment capacity of a HC unit with  $n$  bottom strands is given on the basis of the theory of plasticity by

Fig. 6: Linear elastic stress distribution over the height of the cross section due to prestressing and bending moments and non-linear stress distribution in the crack close to flexural failure (Fellinger, 2004)

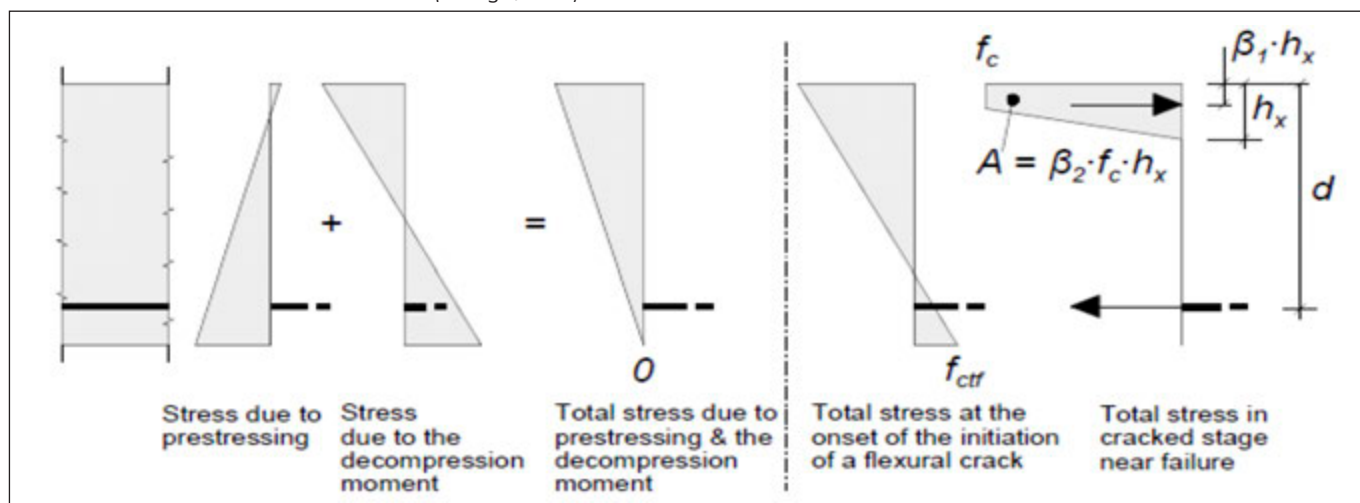

$$M_F = \sum_j^n z^j A_p^j f_p^j = \sum_j^n (h - \beta_1 h_x - c^j) A_p^j f_p^j \quad (1)$$

The height of the compressive zone  $h_x$  can be calculated on the basis of horizontal equilibrium as:

$$h_x = \frac{1}{\beta_2 b f_c} = \sum_j^n A_p^j f_p^j \quad (2)$$

In which  $f_p$  is the steel strength,  $A_p$  the cross sectional area of each bottom strand  $j$ ,  $f_c$  the concrete compressive strength,  $b$  the width of the unit,  $h$  the slab depth,  $c$  the axis distance, i.e. the distance from the centroid of the strands to the bottom of the slab, and  $\beta_1$  and  $\beta_2$  shape factors for the concrete stress-strain relationship with ratio ranges from 1/2 to 2/3.

#### 4.2.2 Anchorage

When a flexural crack appears, the tensile stresses in the concrete drop. Thus, the tensile force in the strand is locally increased to achieve equilibrium, see Fig. 5. The stress increment in the strand depends only on the concrete tensile strength and the ratio between the concrete area in tension that releases the stress and the cross section of the strands that takes over this stress. Bond stresses between the strand and the concrete will play significant role by building up the tensile force.

Anchorage failure can occur either in a brittle or in a ductile way. The transition between brittle and ductile anchorage failure is determined by the position of the flexural crack. If the flexural crack occurs within the so-called critical length from the slab end, the embedment length of the strand is insufficient to take over the stress released in the crack and cracking will cause brittle failure. If the flexural crack appears outside the critical length but within the so-called development length ductile anchorage failure occurs. Outside the development length, the embedment length is long enough to allow for full yielding of the strand. The maximum steel stress envelop is schematically presented in Fig. 7. The stress envelope is simplified to a tri-linear diagram defined by the transfer length and the development length thus, both should be calculated.

Brittle anchorage failure type occurs if the flexural crack is located close to the slab end. In that case, the steel stress increment due to crack cannot be developed in the strand. The strand is immediately pulled out. The anchorage capacity at this case equals the cracking moment resistance, which consists of the decompression moment ( $M_0$ ) and a part causing tensile stresses in the bottom. The decompression moment is the moment that counteracts the prestress in which no axial

Fig. 7: Stress envelope for the strand (Fellinger, 2004)

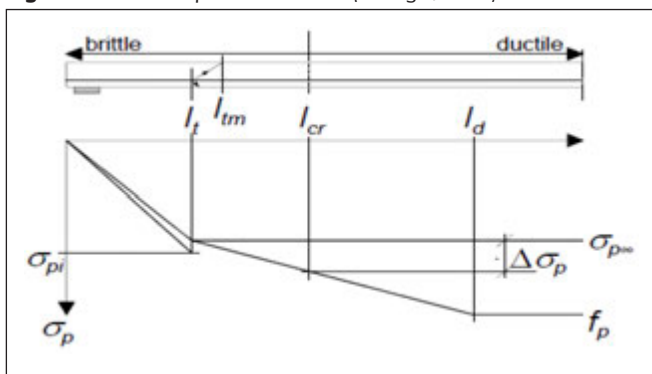

stress remains in the bottom, see Fig. 5. It can be calculated from the linear elastic beam theory. So, anchorage capacity can be evaluated through the following equation:

$$M_{cr}(x) = W_0 f_{ctf} + M_0(x) \quad (3)$$

In which  $W_0$  is the section modulus of the lower half of the total cross section including the contribution of the steel strands.  $f_{ctf}$  is the flexural tensile strength of concrete which can be derived from the mean splitting tensile strength according to the Model Code [CEB-FIP: 1991].

On the other hand, ductile anchorage failure occurs when the initial stress increment due to cracking can be sustained by the strand, but further increase of the load causes pull out of the strand before it yields. The calculation of the ductile anchorage capacity is similar to that of the flexural capacity, refer to eq. 1, i.e. the bending moment equals the tensile force in the strands multiplied with the internal lever arm ( $z$ ). By application of the theory of plasticity for anchorage failure based on bond-slip behaviour, the anchorage capacity then is:

$$M_A(x) = \sum_j^n z^j A_p^j \sigma_p^j(x) = \sum_j^n (h - \beta_1 h_x - c^j) A_p^j \sigma_p^j(x) \ll M_{cr}(x) \quad (4)$$

In order to calculate the anchorage capacity, the transfer length and the development length are given by the Model Code [CEB-FIP: 1991]

#### 4.2.3 Shear compression

When a crack initiated in the area of bending moment and shear force it tend to be inclined crack. The shear force is then transmitted by aggregate interlock in the crack, the dowel action of the strand and by the uncracked compression zone. While the crack grows, the capacity of all contributions decreases. Since the deterioration mode starts with flexural cracks up to failure, it is sometimes also referred to as flexural shear failure.

Over the past 40 years, various models were developed for shear compression failure. Kani (1964) developed an analytical model that describes the shear compression behaviour of reinforced beams without shear reinforcement. A simply supported beam loaded by two equal point loads. Due to the flexural cracks, the beam transforms into a comb-teeth like structure. The compressive zone of the beam is the backbone of the comb (see Fig.8). The teeth of the structure are loaded as cantilever beams by the bond stresses. This loading causes the teeth to bend, leading to additional tensile stresses at the crack tip, which drives the crack to propagate.

Several of researches have been conducted based on the comb-teeth model introducing contribution parts i.e. aggregate interlock and dowel action. Hedman and Losberg (1978) derived a formula for shear compression based on statistical evaluation of shear tests. It was as:

$$V_{SC} = \gamma_{SC1} \sum b_w d k_s k_{ta} \left(1 + 50 \frac{A_p}{\sum b_w d}\right) \sqrt{f_{cm}} + \gamma_{SC2} \frac{M_0}{a} \quad (5)$$

( $f_{cm}$ ) term is a measure for the tensile strength, therefore is expressed in MPa. The calibration factor  $\gamma_{SC1}$  is 0.104 and  $\gamma_{SC2}$  is 1.23 to predict the mean shear capacity and  $\gamma_{SC1}$  is 0.068 and  $\gamma_{SC2}$  is 1 to obtain a 95 % characteristic lower bound.  $M_0$  is the decompression moment and  $a$  the distance between the point load and the support.  $k_s$  is the scale factor according to

$$k_s = 1.6 - d \ll 1$$

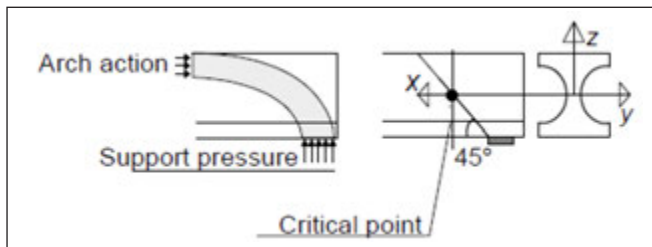

**Fig. 9:** Critical point, assumed just outside the zone strengthened by the introduction of the support reaction (Fellinger, 2004)

With  $d$  in meters and  $k_{ta}$  is the factor including increased shear resistance near the support.

$$k_{ta} = \frac{3d}{a} \leq 1$$

#### 4.2.4 Shear tension

Shear tension failure starts with cracking near the support of the HC slab caused by shear stresses in the web. With no reinforcement to take over the tensile stress, shear tension capacity significantly decreases. The brittle behaviour propagates cracking immediately which cause brittle failure. The combination of shear stress and axial stress causes a principal tensile stress which has an inclination of approximately 45°. The maximum shear stress occurs at the support which has not fully developed of prestress at the slab end. Therefore the principal tensile stress reaches its maximum in the thinnest part of the web near the support. Nevertheless, the crack will not occur exactly at the support, because the stress distribution is disturbed near the support due to the vertical support pressure. So, the crack will be initiated in the web just outside the zone that is strengthened by the support pressure. In shear tension models, this starting point of cracking is called the critical point. (Fig. 9)

For very short shear spans, the slab can even act as a tied arch, which means that the support pressure is directly transferred to the point load through a concrete arch, tied by the strands.

Thus, shear tension capacity will be as:

$$V_{ST} = \frac{\sum b_w l_z}{s_z} \sqrt{\alpha_{cp} \frac{A_p}{A_c} \sigma_{p\infty} f_{ct} + f_{ct}^2} \quad (6)$$

This formula is based on the assumption that shear capacity is to be reached if the principal stress equals the tensile strength

( $\sigma_1 = f_{ct}$ ). The principal stress can be calculated on basis of basic tensor algebra ( $I_1, I_2$  and  $I_3$ ). ( $\alpha_{cp}$ ) is the reduction factor for the prestress in the critical point, ranging between 0.15-0.25 for practical cases. ( $\sum b_w$ ) is the minimum web width.

From other side, ACI 318 (1995) uses another equation

$$V_{ST} = \gamma_{ST} \left( 1.33\sqrt{f_c} + 0.3 \alpha_{cp} \frac{A_p}{A_c} \sigma_{p\infty} \right) \sum b_w d \quad (7)$$

In which  $f_c$  is the cylinder compressive strength in MPa and the safety factor for the model uncertainty of shear tension, equal to 0.85

## 5. FACTORS GOVERNING THE SHEAR RESPONSE OF HC UNDER FIRE

There are many of influencing parameters that affect the shear behavior of HC slabs, i.e. slab depth, load level, loading pattern, axial restraint, level of prestressing and fire scenario. At this review, these factors will be presented as follows: (based on Kodur and Shakya, 2017).

### 5.1 Effect of slab depth

Results showed that sectional temperatures typically decrease with increase in slab depth (higher thermal inertia). It was also noticed that lower sectional temperatures in thicker slabs lead to improve fire resistance in the slabs whereas thinner slabs undergo higher rate of deflection comparing to thicker slabs (higher sectional temperatures). The results infer that thicker slabs are more susceptible to shear failure as compared to thinner slabs, especially when the thickness exceeds 250 mm.

### 5.2 Effect of load level

To study the effect of load level on shear response, 200 mm and 400 mm slabs are analyzed under three different levels of loading, 50, 60 and 85% of room temperature for moment capacity (see Fig. 2). The results showed that higher load levels lead to higher deflections and lower fire resistance, indicating that load level has significant effect on the fire resistance of HC slabs. A review of crack patterns from ANSYS analysis results clearly show that 200 mm slab fail through flexural failure mode, while 400 mm slabs fail

**Fig. 10:** HC slabs subjected to various loading scenarios (Kodur and Shakya, 2017)

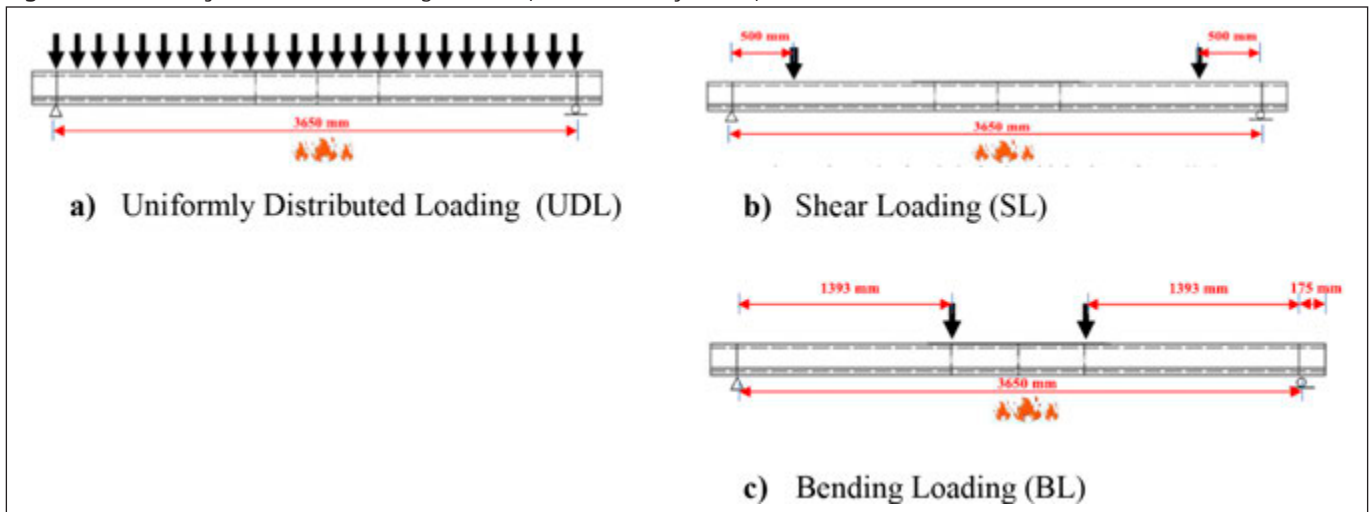

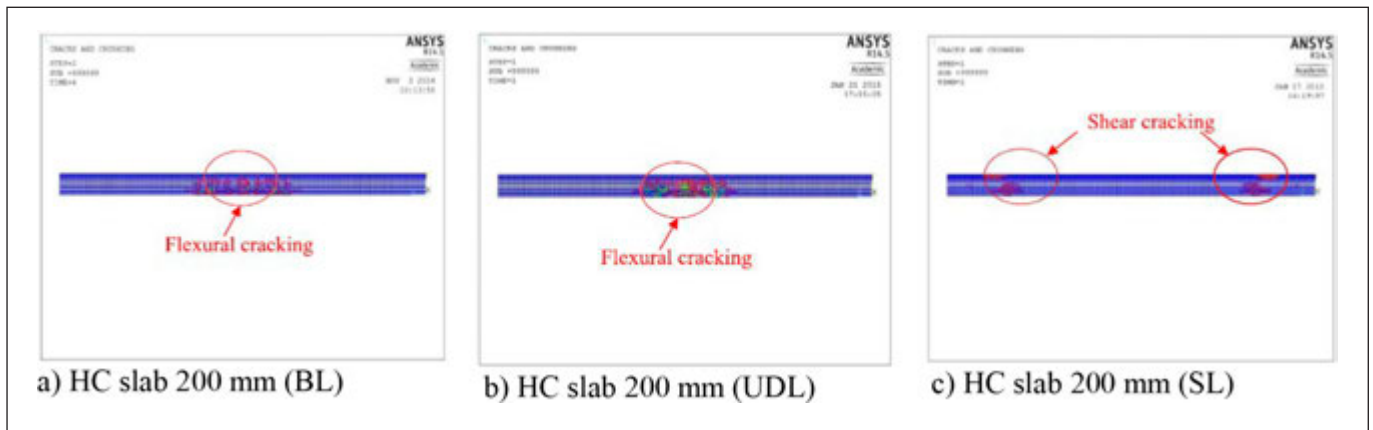

**Fig. 11:** Effect of loading scenarios on crack pattern in HC slabs exposed to fire: (a and b) when the element is subjected to bending and uniformed respectively whereas (c) when it is subjected to shear load (Kodur and Shakya, 2017)

through shear failure mode under all three cases of loading 50, 60 and 85% of the capacity. These results further infer that in thicker slabs, failure occurs through shear limit state under fire conditions.

### 5.3 Effect of loading scenarios

To study the effect of loading pattern, 200 mm and 400 mm thick HC slabs were analyzed under three different loading scenarios, concentrated bending loading (BL), distributed loading (UDL) and shear loading (SL) (Fig. 10).

Results infer that shear limit state can govern failure even in thinner HC slabs when subjected to high shear forces under fire conditions as shown in Fig. 11.

### 5.4 Effect of axial restraint

In order to study the effect of axial restraint on the behavior of HC slabs under fire conditions, 200 mm and 400 mm HC slabs were tested under 50 and 100% axial restraints.

The results show that presence of axial restraint enhances fire resistance of HC slabs through redistribution of stresses and in turn delaying the failure. Results also illustrate that slabs with 100% axial restraints undergo lower deflections and exhibit higher fire resistance, as compared to those with 50% axial restraint at supports. Similarly, slabs with 50% axial restraints undergo lower deflections and exhibit higher fire resistance than those without any axial restraints.

These results infer that presence of high axial restraint can enhance the fire resistance and also prevent shear failures in thicker slabs.

### 5.5 Effect of level of prestressing

To study the effect of level of prestressing on fire resistance, 200 mm and 400 mm HC slabs were analyzed under three different levels of prestressing, namely 50, 70 and 85%. The results infer that, although an increase in level of prestressing can lead to improved structural (moment and shear) performance at ambient conditions, the effectiveness of prestressing gets diminished at elevated temperature. This is attributed to the loss in strand strength which therefore lead to insignificant improvement in the overall fire resistance.

### 5.6 Effect of fire scenario

The results infer that fire intensity has significant effect on the fire response and failure modes of PC hollow core slabs, wherein a higher intensity fire results in lower fire resistance and can shift failure mode from shear to flexure in thicker

HC slabs. This can be attributed to the fact that the flexural capacity of HC slab is mainly dependent on the strand temperature, and under higher fire intensity, temperature in strands increase at a much higher rate than at inner concrete layers, causing rapid degradation in moment capacity than shear capacity.

## 6. CONCLUSIONS

Fire accidents are often inevitable in buildings. This must be taken into account in design of structural members. Hollow core (HC) slabs are widely used in all Europe as well as around the world. Hollow core slabs have been studied in numerous experiments.

HC slabs have no reinforcement other than the longitudinal prestressing wires or strands, anchored by bond. Subsequently it uses 30% less concrete and 50% less steel. As a result, HC slabs possess lower shear capacity as compared to traditional solid slabs. Therefore, HC slabs, unlike solid slabs in which failure is predominantly governed by flexural capacity, are susceptible to shear failure at both ambient and elevated temperatures.

Four failure modes, at ambient temperatures were observed for hollow core slabs by Walraven and Mecx (1983) i.e. flexural failure, anchorage failure, shear tension and shear compression failures. At elevated temperatures, HC slabs are exposed to high levels of temperatures causing thermal influences. *Thermal Strain* is the largest component that essentially measured by the difference between the strain measured during first heating without load and that measured during first heating under load.

Fellinger (2004) studied the four failure mode equations presented by Walraven and Mecx (1983). He compared the equations to his theoretical and experimental results on HC slabs at elevated temperatures. Finalized formulas have been presented for all types of the failure.

On the other hand, Eurocode 2 presents requirements for fire design including requirements for mechanical resistance to maintain load bearing function during fire. It provides three options for determining the fire resistance prestressed precast structures, i.e. tabular, simplified or advanced methods. Additional rules have been provided in case of hollow core slabs. ACI, based on PCI, provides a rational design methodology for evaluating the fire resistance of precast, prestressed concrete slabs based on strength degradation of strand with temperature. ACI also specifies minimum slab and concrete cover thicknesses to achieve a required fire-resistance.

Finally, several parameters have been investigated in the literature. Some of critical parameters that affect the shear behavior of HC slabs are presented at this paper as; slab depth, load level, loading pattern, axial restraint, level of prestressing and fire scenario.

## 7. ACKNOWLEDGEMENTS

Authors acknowledge the support by the Hungarian Research Grant NVKP\_16-1-0019 “Development of concrete products with improved resistance to chemical corrosion, fire or Freeze-thaw”.

## 8. REFERENCES

- Abrams, M. S. (1976), “Fire Tests of Hollow-Core Specimens with and without Roof Insulation.” *PCI Journal* 21 (1), pp. 40–49. <https://doi.org/10.15554/pcij.01011976.40.49>
- Acker, A. V. (2003), “Shear Resistance of Prestressed Hollow-Core Floors Exposed to Fire.” *Structural Concrete* 4 (2), pp. 65–74. <https://doi.org/10.1680/stco.2003.4.2.65>
- ACI (American Concrete Institute) Committee 318. (2011), *Building Code Requirements for Structural Concrete (ACI 318-11) and Commentary (ACI 318R-11)*. Farmington Hills, MI: ACI.
- ACI 216.1. (2007), *Code Requirements for Determining Fire Resistance of Concrete and Masonry Construction Assemblies*. ACI 216.1-07. Farmington Hills, MI: ACI.
- Andersen, N. E., and D. H. Lauridsen. (1999), Danish Institute of Fire Technology Technical Report X 52650 Part 2: Hollow-Core Concrete Slabs. Jernholmen, Denmark: Danish Institute of Fire Technology
- Angelakos, D., Bentz, E. C., and Collins, M. P., (2001), “Effect of Concrete Strength and Minimum Stirrups on Shear Strength of Large Members,” *ACI Structural Journal*, V. 98, No. 3, pp. 290–300
- Bailey, C. G., and T. Lennon. (2008), “Full-Scale Fire Tests on Hollow-Core Floors.” *The Structural Engineer* 86 (6), pp. 33–39.
- Borgogno, W. (1997), “Structural Behavior of Slim Floor Covering with Concrete Hollow Slabs at Room Temperature and Elevated Temperature.” *PhD thesis*. Swiss Federal Institute of Technology, Zurich, Switzerland.
- CEB-FIP: (1991), *Model Code 1990 - Design Code for Concrete Structures*, Thomas Telford, Trowbridge
- Dwairi, H., Rizkalla, S., and Kowaisky, M., (2005), “Shear Behavior of Concrete Beams Reinforced with MMFX Steel Without Web Reinforcement,” *Constructed Facilities Laboratory*, North Carolina State University, October 2005, 14 p
- Elematic, (2012), “Hollow-core slab production plan: Hollow-core slab production by extruder”. Elematic Oy Ab, Finland.
- EN 1991-1-2., Eurocode 1 (2002), “Basis of Design and Action on Structures, Part 2.2: Actions on Structures Exposed to Fire”, CEN, Brussels, Belgium: *European Committee for Standardization*
- EN 1992-1-1, Eurocode 2. (2004), “Design of Concrete Structures, Part 1–1: General Rules and rules of buildings”, ENV 1992-1-2, Document CEN. Brussels, Belgium: *European Committee for Standardization*
- EN 1992-1-2, Eurocode 2. (2004), “Design of Concrete Structures, Part 1–2: General Rules—Structural Fire Design”, Document CEN. Brussels, Belgium: *European Committee for Standardization*
- EN 1168 (2005 and 2011) Precast concrete products – Hollow core slabs. *European Committee for Standardization*, 81p.
- Fellinger, J.H.H. (2004), “Shear and Anchorage Behaviour of Fire Exposed Hollow Core Slabs”, *PhD Thesis*, Department of Civil Engineering, Delft University of Technology, Netherlands
- fib* (2007), “Fire design of concrete structures, materials, structures and modelling”, *fib Bulletin* 38, *International Federation for Structural Concrete*, Lausanne, Switzerland
- Hawkins, N.M., Ghosh, S.K. (2006), “Shear strength of hollow core slabs”. *Prestressed Concr. Inst. J.* 30, pp. 110–114.
- ISO 834-1 (1999), “Fire-Resistance Tests - Elements of Building Construction - Part 1: General Requirements”, ISO, Geneva, Switzerland
- Jansze, W. Acker, A. V. Bella, B. D. Klein-Holte, R. Lindstrom, G. Nitsch, A. Py, J.P. Robert, F. and Scalliet, M. (2012), “Fire resistance of hollow core floors regarding shear and anchorage capacity”, *Structures in Fire Sif 2012. Proceedings of the 7th International Conference on Structures in Fire*. Zurich, Switzerland.
- Jensen, J. F. (2005), “Hollow-Core Slabs and Fire—Documentation on Shear Capacity”. Copenhagen, Denmark: Danish Prefab Concrete Association, *Danish Institute of Fire Technology*
- Khoury, G.A.(2006), “Strain of heated concrete during two thermal cycles. Part 1: strain over two cycles, during first heating and subsequent constant temperature”, *Magazine of Concrete Research*, 58, No. 6, August 2006, pp. 367-385. <https://doi.org/10.1680/macr.2006.58.6.367>
- Kodur, V.K.R. and Shakya, A.M. (2017), “Factors governing the shear response of prestressed concrete hollowcore slabs under fire conditions”, *Fire Safety Journal*, 88, pp. 67-88. <https://doi.org/10.1016/j.firesaf.2017.01.003>
- Kodur, V.K.R., Shakya, A.M. (2014), “Modeling the response of precast prestressed concrete hollowcore slabs exposed to fire”, *Prestress. Concr. Inst. J.* 59, pp. 78-94
- Lubell, A. J., Sherwood, F. G., Bentz, E. C., and Collins, M. P., (2003), “Safe Shear Design of Large Wide Beams,” *Concrete International*, V. 25, No. 11, November
- PCI Industry Handbook Committee. (2010), *PCI Design Handbook: Precast and Prestressed Concrete*. MNL120. 7th ed. Chicago, IL: PCI.
- PCI Producers committee, (2015), *PCI Manual for the Design of Hollow Core Slabs and Walls*. MNL-126-15E. Third edition-Electronic version.
- Rahman, M.K., Baluch, M.H., Said, M.K., Shazali, M.A. (2012), “Flexural and shear strength of prestressed precast hollow-core slabs,” *Arab. J. Sci. Eng.* 37. PP. 443–455.
- Schepper, L., and N. E. Andersen. (2000), “Fire Test of Deck Elements”. Technical report PG 10724. Copenhagen, Denmark: Danish Institute of Fire Technology and COWI Group
- Venanzi I, Breccolotti, M., D’Alessandro A., Materazzi, A.L. (2014), “Fire performance assessment of HPLWC hollow core slabs through full-scale furnace testing”. *Fire Safety Journal* 69, pp. 12-22. <https://doi.org/10.1016/j.firesaf.2014.07.004>
- Walraven, J. C. & W. P. M. Mercx. (1983), “The Bearing Capacity of Prestressed Hollow Core Slabs.” *Heron* 28(3), pp. 1-46.
- Naser Alimrani** (1989), PhD student at the Department of Construction Materials and Technologies, Budapest University of Technology and Economics. His main fields of research interest are: fire design, behaviour of concrete at elevated temperature and shear properties in concrete at elevated temperatures in addition to failure modes concrete elements at high temperatures especially hollow core slabs, bond properties and bond stress-slip relationships. Member of the Hungarian Group of *fib*.
- György L. Balázs** (1958), Civil Engineer, PhD, Dr.-habil., Professor of structural engineering at the Department of Construction Materials and Technologies of Budapest University of Technology and Economics (BME). His main fields of activities are experimental investigation and modeling of RC, PC, FRC, FRP, HSC, HPC, LWC, fire resistance and fire design, durability, sustainability, bond and cracking. He is chairman of several commissions and task groups of *fib*. He is president of Hungarian Group of *fib*, Editor-in-chief of the Journal “Concrete Structures”. He was elected as President of *fib* for the period of 2011-2012. Since then he is Honorary President of *fib*. Chairman of *fib* Com 9 Dissemination of knowledge.

# SELF-COMPACTING HIGH-PERFORMANCE CONCRETE IN TERMS OF MIXING PROPORTIONS AND PROCEDURE



Mohammed Abed

DOI: 10.32970/CS.2018.1.4

*Self-compacting high-performance concrete (SCHPC) is a special type of concrete, which could perform optimally with respect to flow characteristics, strength, transport properties and durability while maintaining the required service life under a given set of material load exposure conditions. Therefore, the production of SCHPC involves more stringent control on the selection of constituent materials than do other types of concrete. Optimal mix design of SCHPC is assessed to optimise fresh and hardened properties. The optimisation has been based on the basic material aspects of SCHPC, namely, aggregate fraction distribution, water to cement (w/c) ratio, and cement content, in addition to the mixing procedure. Thus, all the proposed factors have to be considered to achieve the maximum possible compressive strength by taking into considerations the minimum required highrange water reducer admixture (HRWRA) dosage. SCHPC proved its sensitivity to the ingredient proportions and mixing procedure, which is much more than other types of concrete, where they had a significant effect on the compressive strength and workability performance of SCHPC.*

**Keywords:** self-compacting concrete, high-performance concrete, compressive strength, mixing proportions, mixing procedure

## 1. SELF-COMPACTING CONCRETE

Self-compacting concrete (SCC) is a special type of concrete which spreads through congested reinforcement, reaches every corner of frameworks and consolidates under its own weight, thus providing excellent filling capability and good segregation resistance (Khayat, 1999). Such difficulties, such as lack of skilled workers and durability damages caused by inadequate compaction, complex and difficult shapes of structural elements and congestion of steel reinforcement, were the main motivations for Japanese researchers to introduce SCC, which offers health and safety benefits (Okamura and Ouchi, 2003). However, normal SCC remains prone to poor durability and strength, which could be overcome by the use of cement replacing materials (CRMs) and reduction of the water to binder (w/b) ratio.

## 2. HIGH-PERFORMANCE CONCRETE

High-performance concrete (HPC) was introduced by researchers as a result of their trials for overcoming the drawbacks of conventional normal concrete. They changed the concrete constituents, mixing procedure and carrying process to improve the particular zone of hydrated paste in the proximity of aggregates, which is called the interfacial transition zone (ITZ). The American Concrete Institute (ACI) defines HPC as 'a concrete meeting special combinations of perfor-

mance and uniformity requirements that cannot always be achieved routinely using conventional constituents and normal mixing' (ACI CT-13, 2013). The major disadvantage of HPC is its low flow and filling capability caused by the low w/b ratio, which could overcome by the use of High-range water reducer admixture (HRWRA) and CRMs.

An alternative in the advancement of concrete technology is the combination of the performance characteristics *high strength and durability* of HPC with the workability characteristics *high flow and filling capability* of SCC to produce Self-compacting high-performance concrete (SCHPC).

## 3. SELF-COMPACTING HIGH-PERFORMANCE CONCRETE

SCHPC is a special type of concrete, which could perform optimally with respect to flow characteristics, strength, transport properties and durability while maintaining the required service life under a given set of material load exposure conditions. SCHPC's performance at fresh and hardened states differentiate it from ordinary concrete types. This feature is driven by the incorporation of special ingredients in certain proportions, such as HRWRA and CRMs, in addition to standard materials used for all concretes, such as aggregates, sand, cement and water (Safiuddin, 2008).

The proportions of SCHPC mixtures also differ from those used in ordinary concrete; binder volume, fine aggregate and powders and HRWRA are higher in the former than in the



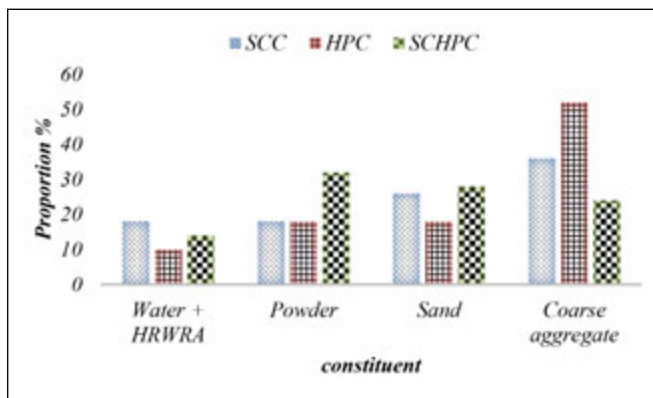

**Fig. 1:** Typical constituents' ratios of SCC, HPC and SCHPC

latter, whereas the w/b ratio and coarse aggregate are lower. The w/b ratio is recommended to be from 0.2 to 0.4 in case of SCHPC (Persson, 2001). Ghanbari (2011) proposed typical ratios of constituents for normal SCC and HPC and for SCHPC, as shown in Fig.1.

### 3.1 Advantages of SCHPC

SCHPC offers more advantages than does ordinary concrete and includes the advantages of SCC and HPC; these advantages could be grouped into three (Cameron, 2003; Okamura and Ouchi, 2003; EFNARC, 2005; EFNARC, 2002; Safiuddin, 2008), which are discussed in the following sub-sections.

#### 3.1.1 Constructional value

SCHPC flows through and around reinforcing steel under self-weight without using any means of compaction, thereby

enhancing compactness and reducing porosity and consequently providing improved strength. Its own compaction facilitates and simplifies the execution process of complex design elements and cast of complicated architectural forms, especially in case with large amounts of reinforcement in small sections. SCHPC is also a watertight concrete; it reduces transport properties, enhances durability and eliminates surface pores, thus providing good finishing without the need for improvement.

#### 3.1.2 Environmental value

The construction environment could be improved with reduction of construction noise and decrease of construction time, where a concrete vibrating equipment is not required. SCHPC consumes large amounts of CRMs (waste materials), which saves the environment from excessive waste materials, cement production and disposal places.

#### 3.1.3 Economic value

SCHPC helps in decreasing the number of required labourers for the transport and placement of concrete, thereby reducing the costs of construction and saving large quantities of concrete due to the reduced sections of structural components. This material allows for a quickened reuse of formwork, which can last longer due to the elimination of vibration equipment and thus enhances the production rate.

### 3.2 Performance criteria of SCHPC

The use of HRWRA for producing high levels of workability and segregation-resistant concretes was introduced more than

**Table 1:** Performance criteria of SCHPC (Safiuddin, 2008)

Methods	Properties	Performance criteria
<b>SCC properties</b>		
Slump	Filling ability	250–280 mm
Slump flow	Filling ability, segregation resistance	550–850 mm
V-funnel flow	Filling ability, segregation resistance	5–14 s
Orimet flow with 80 mm orifice	Filling ability, segregation resistance	2.5–9 s
Filling percentage in fill-box	Filling ability, passing ability	90%–100%
Blocking ratio in L-box	Filling ability, passing ability, segregation resistance	>0.8
Filling height in U-box	Filling ability, passing ability	30 mm
Slump cone – J-ring flow	Reduction in slump flow as measure of passing ability	50 mm
Penetration depth	Segregation resistance	8 mm
Sieve segregation	Segregation resistance	18%
<b>HPC properties</b>		
Air content by pressure method	Fresh air content	4%–8%
Axial compression on cylinders	28- and 91-day compressive strength	>40 MPa
Ultrasonic pulse velocity by PUNDIT	Physical quality or condition (packing, uniformity, etc.)	≥4575 m/s
Porosity by fluid displacement method	Porosity by fluid displacement method	7%–15%
Absorption by water saturation technique	Water absorption as indicator of durability	3%–6%
True electrical resistivity by Wenner probe	Electrical resistance to corrosion	>5–10 kΩ-cm
Rapid chloride ion penetration	Electrical charge passed as indicator of corrosion resistance	<2000 C
Normal chloride ion penetration at 6 months	Penetrated chloride value as indicator of corrosion resistance	<0.07%
Durability factor after 300 cycles of freeze-thaw	Resistance to freezing and thawing	>0.8

one decade before the development of SCHPC (The first prototype of SCHPC was developed in 1988.) (Okamura, 1995; Safiuddin, 2008; Collepardi, 1976). The Japanese concrete industry commercialised SCHPC in the forms of ‘non-vibrated concrete’, ‘super-quality concrete’, and ‘biocrete’.

SCHPC has to fulfil the performance criteria of SCC in the fresh state and of hardened HPC to ensure adequate mechanical and durability properties. Safiuddin (2008) summarised these performance criteria, which could be specified for SCHPC by an examination of several SCC and HPC works (Bui et al., 2002; Khayat, 2000; Kosmatka and Cement Association of, 2002; EFNARC, 2005; EFNARC, 2002). These performance criteria are presented in **Table 1**.

### 3.3 Material aspects of SCHPC

Similar to ordinary concrete, SCHPC consists of cement, coarse aggregates, fine aggregates and water; however, HRWRA and CRMs are highly important in SCHPC. The characteristics of its ingredients highly affect its performance in fresh and hardened states. Therefore, the production of SCHPC involves more stringent control on the selection of constituent materials than do other types of concrete. The constituent materials are the defining factors in achieving the expected benefits from SCHPC.

#### 3.3.1 Coarse aggregate

Coarse aggregate is that retained in a 4.75 mm (No. 4) sieve. It is a main ingredient and constituent of concrete and distinguishes concrete from mortar. The physical characteristics, porosity and grading of coarse aggregate significantly influence the performance of SCHPC by affecting its fresh and hardened properties (Okamura, 1995; Xie et al., 2002). The use of small coarse aggregates measuring 20–25 mm at most is preferred in SCHPC for enhanced strength and reduced segregation (Kwan, 2000). Round and angular aggregates are advantageous for SCHPC either in fresh or hardened state; however, round aggregates are better than angular aggregates for improved flowing ability, whereas rough and angular aggregates lead to high strength and strong interfacial bond (Geiker et al., 2002; Taylor et al., 1996). The porosity and reactivity of coarse aggregates play an important role in the durability of SCHPC; porous aggregates negatively affect strength and frost resistance.

The gradation of coarse aggregates is likewise important for the fresh and hardened properties of SCHPC; well-graded coarse aggregates enhance the flowing ability and segregation resistance in fresh concrete (Neville, 2009). It also produces dense particle packing, which improves hardened properties (Tasi et al., 2006).

#### 3.3.2 Cement replacement materials

CRMs or supplementary cementing materials are powder materials that contribute to the properties of hardened concrete through hydraulic and/or pozzolanic activity. In case of SCHPC; high strength and good durability are the prime goals. Thus, CRMs are highly important to achieving these objectives and an essential material that must be used for promoting SCHPC. CRMs are considerably helpful in enhancing concrete’s properties through their physical and chemical effects on material packing and microstructure (Hassan et al., 2000; Hooton, 2000; Khatri et al., 1995). Such standards specify the physical and chemical requirements for natural and artificial CRMs, which provide the limits for fineness,

expansion or contraction, pozzolanic activity, uniformity, reactivity, limits for several chemical components and igneous loss.

#### 3.3.3 High-range water reducer admixture

The SCHPC cannot be achieved without the use of HRWRA, which is also known as superplasticiser. It improves the flowing ability and reduces the yield stress and plastic viscosity of concrete by its liquefying action (Yen et al., 1999). HRWRA helps in enhancing the strength and durability of concrete by improving hydration through increased dispersion of cement particles and decreased quantity of mixing water for a given flowing ability (Hover, 1998). HRWRA comes in four types, among which polycarboxylate HRWRA, a second-generation HRWRA, is generally preferred for producing SCHPC. The required amount of HRWRA changes significantly with the concrete’s constituents, especially with the substantial difference between the CRMs in their structures and physical properties and with the roughness and absorption of the used aggregate.

### 3.4 Sustainable SCHPC

The construction industry is among the fields most affected by the ongoing sustainability debate primarily due to the substantial environmental impact resulting from the production of building materials, construction of buildings and structures and the subsequent use thereof (Mueller et al., 2017). Concrete can become green or environmental friendly when one or more of the following properties is achieved (Suhendro, 2014).

1. It uses waste materials as at least one of its components.
2. Its production process does not lead to environmental destruction.
3. It enhances the durability of concrete, thereby extending the latter’s service life and reducing long-term resource consumption.
4. It exhibits superior performance and life cycle sustainability without destroying natural resources.

For developing clean concrete production technologies that reduce CO<sub>2</sub> emission and consumed energy or fuel derived from fossil in the cement manufacturing process, the use of recycled cement/concrete and alternative aggregates is being explored.

Approximately 10% of the total man-made CO<sub>2</sub> emitted into the atmosphere is produced during cement manufacturing (Long et al., 2015). Researchers have attempted to produce sustainable concrete mainly through utilising waste materials (construction or industrial waste) and evaluating the sustainability of these new types of concrete not only by their ecological impact but also by their technical performance, i.e. their mechanical, physical and chemical properties (Mueller et al., 2017). As Ajdukiewicz and Kliszczewicz (2002) stated in their research, green high-performance concrete is the future of concrete development. Thus based on the materials aspects of SCHPC, three possibilities could propose a sustainable SCHPC:

1. Recycled concrete aggregate could be used partially for producing SCHPC, which is a porous crushed aggregate.
2. Unpossessed waste powder materials could be used as CRMs for producing SCHPC without any processing preceding the use or consumption of any energy for this purpose.
3. An optimised minimum dosage of HRWRA could be used for producing SCHPC using waste powder materials and recycled concrete aggregate.

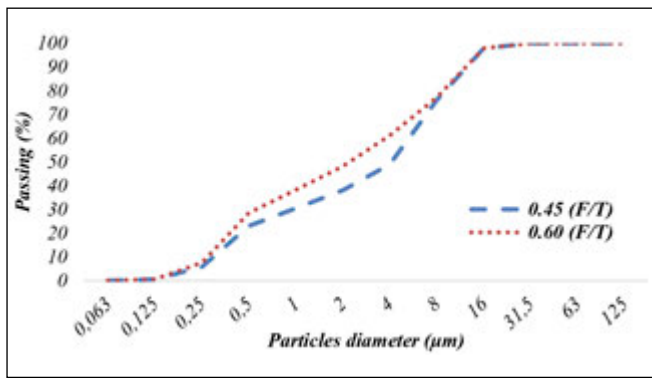

Fig. 2: Grading curves of the aggregate

## 4. CASE STUDY: REFERENCE SCHPC MIXTURE OPTIMIZATION

An initial optimisation exercise was performed for specifying the most appropriate constituent proportions and mixing procedure of the reference mixture of SCHPC. Ahmad and Alghamdi (2014) defined the optimization of the concrete mixture design as ‘a process of search for a mixture for which the sum of the costs of the ingredients is lowest, yet satisfying the required performance of concrete, such as workability strength and durability’.

The optimization was based on the targeted compressive strength and workability performance, which were 75 MPa and (SF2 class of slump flow and VF1 viscosity class) respectively. Four variables were optimised, namely, aggregate fraction distribution, water to cement (w/c) ratio, cement content, and mixing procedure. Two aggregate fraction distributions were optimised. The first one was 45% for 0/4 mm fraction and 55% for 4/16 mm fraction, whereas the second was 60% for 0/4 fraction and 40% for 4/16 fraction, which of which fit the requirements of BS EN 1260:2002+A1 (2008) and shown in Fig. 2. In addition, two w/c ratios, namely, 0.35 and 0.38, were selected to be tested for their effect on the HRWRA demand and compressive strength. Finally, two amounts of cement content, namely, 450 and 500 kg/m<sup>3</sup>, were investigated.

### 4.1 Experimental program

An experimental program was considered in the purpose of studying the effect of the proposed factors and optimizing the reference SCHPC mixture design. Eight concrete mixtures have been produced with taking into consideration two typical levels of each of the three key factors affecting the performance of concrete mixtures, in addition to observe the efficiency of the mixing procedure and the demanded dosage of HRWRA to achieve the intended workability. The combinations of the levels of the three factors for all eight-trial mixtures are shown in Table 2.

Ordinary Portland cement CEM I 42.5 N in accordance with BS EN 197-1 (2011) has been used, as well as the maximum aggregate size used was 16 mm, which has been chosen based on the literature investigations. The aggregate was a natural river quartz and mainly in two proportions; the fine fraction of aggregate (0/4 mm) and the coarse fraction of aggregate (4/16 mm). The mixing water was tap water that complies with the requirements of BS EN 1008:2002 (2011) while to achieve the rheological properties of the fresh SCHPC; HRWRA has been used. The used HRWRA was Sika Visco-Crete-5 Neu, which is a modified polycarboxylates aqueous solution.

Table 2: Trail mixtures (key factors)

Mixture name	Fine to total aggregate ratio (F/T) %	Water to cement ratio (w/c) %	Cement content (Cc) kg/m <sup>3</sup>
M1	0.45	0.35	500
M2	0.45	0.35	450
M3	0.45	0.38	450
M4	0.45	0.38	500
M5	0.60	0.35	500
M6	0.60	0.35	450
M7	0.60	0.38	450
M8	0.60	0.38	500

Eight concrete mixtures were produced in consideration of the aforementioned variables. For each; four (150x150x150 mm) concrete cubes have been tested for the compressive strength at age of 28 days. The most appropriate mixing procedure was performed for a total mixing time of 4.5 min partitioned into three stages by using an electric concrete mixer. After each stage, the ingredients were manually mixed for achieving the highest homogeneity. Fig. 3 explains the mixing procedure, which has been proposed based on a number of trials for achieving the minimum HRWRA demand and higher strength. The slump flow and v-funnel tests have been conducted directly after mixing to check if the mix achieved the SF2 slump flow class and VF1 viscosity class based on EFNARC (2005). The SF2 slump flow class is ranged by 660 – 750 mm while the VF1 viscosity class is ranged by 6 – 10 seconds.

### 4.2 STATISTICAL PROGRAM

Analysis of variance (ANOVA) has been used for examining the significance of the factors considered for developing the strength model and subsequently fitting an empirical model for compressive strength in terms of the significant mixture factors using multiple linear regression. Table 3 shows the statistical terminologies, which they are important conduct and understand the ANOVA as proposed by Ahmad and Alghamdi, (2014).

## 5. RESULTS

The optimal reference mixture with target compressive strength reaching 75 MPa and (SF2 and VF1) as a targeted classification for the fresh properties had the following spec-

Fig. 3: Mixing procedure

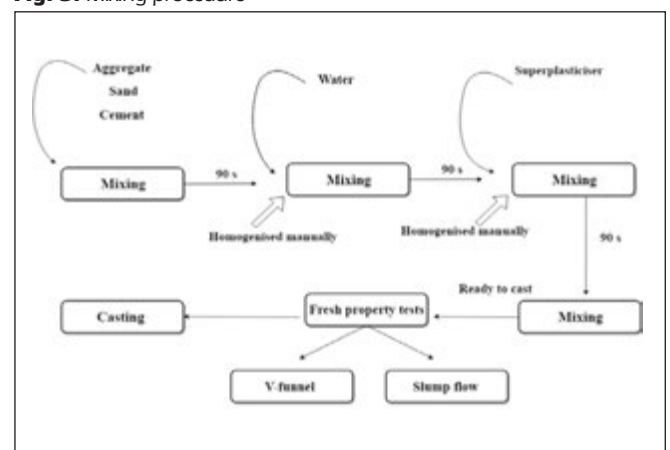

**Table 3:** Description of the statistical terminologies used in ANOVA.

Statistical terminology	Description
Degree of Freedom (df)	It is the number of values in the final calculation of a statistic that are free to vary. $df = n-1$ , where $n$ represents the number of groups.
Sum of Squares (SS)	It is the squared distance between each data point ( $X_i$ ) and the sample mean ( $M$ ), summed for all $n$ data points.
Mean Square (MS)	It is the sum of squares divided by the degrees of freedom.
F-Ratio	It is ratio of MS of the concerned factor to the MS of the error. A higher F-Ratio indicates a significant effect of the factor.
P-Value	It is a measure of acceptance or rejection of a statistical significance of a factor based on a standard that no more than 5% (0.05 level) of the difference is due to chance or sampling error. In other words, if the P-value for a factor is 0.05 or more, it would not have effect on the dependent variable.

ifications: 500 kg/m<sup>3</sup> cement content, 45% for 0/4 mm aggregate fraction, 55% for 4/16 mm aggregate fraction and 0.35 w/c ratio. It is M1 mixture in **Table 4**, which shows the average 28-day compressive experimentally ( $Sc$ ) for all the eight concrete mixtures along with the minimum dosage of the needed HRWRA to achieve the targeted classification for the fresh properties. The data given in **Table 2** and  $Sc$  values given in **Table 4** has been utilized for statistical analysis to examine the significance of the mixture factors and subsequently to obtain a multiple linear regression model for compressive strength in terms of the factors considered.

**Table 4:** Compressive strength test results based on experiments and Eq. (1)

Mixture name	compressive strength based on experiments ( $Sc$ ) MPa	HRWRA dosage kg/m <sup>3</sup>	compressive strength based on Eq. (1) ( $Sc'$ ) MPa
M1	81.98	1.5	81.23
M2	79.29	2	78.13
M3	73.27	2	73.49
M4	75.04	1.5	76.59
M5	77.36	1.75	77.98
M6	73.73	2.25	74.88
M7	70.59	2.25	70.24
M8	74.92	1.75	73.34

Based on the ANOVA test results which done with the Microsoft Excel solver 2013 by utilizing the experimental program results; the multiple linear regression model for the compressive strength has been obtained ( $R^2 = 0.903$ ):

$$Sc' = 114.019 - 21.656(F/T) - 154.425(w/c) + 0.062(Cc) \quad \text{Eq. (1)}$$

Where  $Sc'$  is the 28-day compressive strength in MPa based on Eq. (1),  $Cc$  is the cement content in kg/m<sup>3</sup>,  $w/c$  is the water to cement ratio by mass, and  $F/T$  is the fine to total aggregate ratio by mass. However, the proposed model in Eq. (1) is limited to the range values of the proposed variables.

The results of ANOVA for the compressive strength model are presented in **Table 5**, which shows that the three factors have a significant effect on the compressive strength and workability performance of SCHPC due to the low P-Value (less than 0.05). Thus all the proposed factors have to be considered to achieve the maximum possible compressive strength of SCHPC by taking into considerations the minimum required HRWRA dosage. SCHPC proved its sensitiv-

ity to the ingredient proportions and mixing procedure, which is much more than other types of concrete.

**Table 4** also shows the results of compressive strength based on the proposed model in Eq. (1). In addition, it refers to the optimal reference SCHPC mixture, which complies with the experimental results but with more confidence with its optimal combination. The value of statistical optimization could be clearer in case of more complicated model or in case of a higher number of variables and levels.

## 6. CONCLUSION

Optimal mix design of self-compacting high-performance concrete (SCHPC) is assessed based on the basic material aspects of SCHPC, namely, aggregate fraction distribution, w/c ratio, and cement content, in addition to the mixing procedure. Thus, all the proposed factors have to be considered to achieve the maximum possible compressive strength by taking into considerations the minimum required high range water reducer admixture dosage. SCHPC proved its sensitivity to the ingredient proportions and mixing procedure, which is much more than other types of concrete. Where the proposed factors had a significant effect on the compressive strength and workability performance of SCHPC. As well as the main issues of SCHPC have been introduced with suggestions for a sustainable SCHPC through using recycled concrete aggregate as a partial replacement of natural aggregate and unprocessed waste powder materials as cement replacing materials, in addition to optimising the minimum required dosage of HRWRA.

## REFERENCES

- ACI CT-13 (2013): "ACI Concrete Terminology", ACI Standard; p. 74.
- BS EN 197-1:2011. "Cement Part 1: Composition, specifications and conformity for common cements", *British Standards Institution*.
- BS EN 1008:2002. "Mixing water for concrete-Specification for sampling, testing and assessing the suitability of water, including water recovered from processes in the concrete industry, as mixing water for concrete", *British Standards Institution*.
- BS EN 12620:2002+A1:2008. "Aggregates for concrete", British Standards Institution.
- Ahmad, S. & Alghamdi, S. A. (2014), "A Statistical Approach to Optimizing Concrete Mixture Design. The Scientific World Journal"; p. 7, <https://doi.org/10.1155/2014/561539>.
- Ajdukiewicz, A. & Kliszczewicz, A. (2002), "Influence of recycled aggregates on mechanical properties of HS/HPC", *Cement and Concrete Research*, 24(2), pp. 269-279, [https://doi.org/10.1016/S0958-9465\(01\)00012-9](https://doi.org/10.1016/S0958-9465(01)00012-9).
- Bui, V. K., Montgomery, D., Hinczak, I. & Turner, K. (2002), "Rapid testing method for segregation resistance of self-compacting concrete". *Cement and Concrete Research*, 32(9), pp. 1489-1496, [https://doi.org/10.1016/S0008-8846\(02\)00811-6](https://doi.org/10.1016/S0008-8846(02)00811-6).
- Cameron, I. (2003), "Self-compacting concrete: a versatile material". *Concrete Structures*, 37(2), pp. 16-18.

**Table 5:** ANOVA for compressive strength test results

	<i>df</i>	<i>SS</i>	<i>MS</i>	<i>F</i>	<i>Significance F</i>	
<b>Regression</b>	3	83.297	27.766	12.785	0.016	
<b>Residual</b>	4	8.687	2.172	-	-	
<b>Total</b>	7	91.984	-	-	-	
<i>Source</i>	<i>Coefficients</i>	<i>Standard Error</i>	<i>P-value</i>	<i>Lower 95%</i>	<i>Upper 95%</i>	<i>Significance</i>
<b>Intercept</b>	114.019	16.502	0.002	68.202	159.837	-
<b>(F/T) %</b>	-21.656	6.947	0.036	-40.944	-2.368	yes
<b>(w/c) %</b>	-154.425	34.736	0.011	-250.867	-57.984	yes
<b>(Cc) kg/m<sup>3</sup></b>	0.062	0.021	0.041	0.004	0.120	yes

- Collepari, M., And Massidda, L. (1976), "The influence of water-reducing admixtures on the cement paste and concrete properties. Proceedings of a Conference on Hydraulic Cement Pastes: Their Structure and Properties", Slough, UK: *Cement and Concrete Association*.
- EFNARC 2002, "Specifications and guidelines for self-compacting concrete", English ed.: European federation for specialist construction chemicals & concrete systems.
- EFNARC 2005, "Specifications and guidelines for self-compacting concrete", English ed. European federation for specialist construction chemicals & concrete systems.
- Geiker, M., Brandl, M., Thrane, L. & Nielsen, L. (2002), "On the Effect of Coarse Aggregate Fraction and Shape on the Rheological Properties of Self-Compacting Concrete", *Cement, Concrete and Aggregates*, 24(1), pp. 3-6, <https://doi.org/10.1520/CCA10484J>.
- Ghanbari, A. (2011), "Self-Compacting High and Ultra High Performance Concretes", PhD thesis, Cardiff University.
- Hassan, K. E., Cabrera, J. G. & Maliehe, R. S. (2000), "The effect of mineral admixtures on the properties of high-performance concrete", *Cement and Concrete Composites*, 22(4), pp. 267-271, [https://doi.org/10.1016/S0958-9465\(00\)00031-7](https://doi.org/10.1016/S0958-9465(00)00031-7).
- Hooton, R. D. (2000) "Canadian use of ground granulated blast-furnace slag as a supplementary cementing material for enhanced performance of concrete". *Canadian Journal of Civil Engineering*, 27(4), pp. 754-760, <https://doi.org/10.1139/100-014>.
- Hover, K. C. (1998), "Concrete mixture proportioning with water-reducing admixtures to enhance durability: A quantitative model", *Cement and Concrete Composites*, 20(2), pp. 113-119, [https://doi.org/10.1016/S0958-9465\(98\)00002-X](https://doi.org/10.1016/S0958-9465(98)00002-X).
- Khatri, R. P., Sirivivatnanon, V. & Gross, W. (1995), "Effect of different supplementary cementitious materials on mechanical properties of high performance concrete", *Cement and Concrete Research*, 25(1), pp. 209-220, [https://doi.org/10.1016/0008-8846\(94\)00128-L](https://doi.org/10.1016/0008-8846(94)00128-L).
- Khayat, K. (2000), "Optimization and performance of air-entrained, self-consolidating concrete" *ACI Structural Journal*, 97(5), pp. 526-535.
- Khayat, K. H. (1999), "Workability, testing, and performance of self-consolidating concrete", *ACI Materials Journal*, 96(3), pp. 346-353.
- Kosmatka, S. H. (2002), "Design and control of concrete mixtures, Ottawa", Cement Association of Canada, book, *Cement Association of Canada*.
- Kwan, A. K. (2000), "Use of condensed silica fume for making high-strength, self-consolidating concrete", *Canadian Journal of Civil Engineering*, 27(4), pp. 620-627, <https://doi.org/10.1139/199-091>.
- Long, G., Gao, Y. & Xie, Y. (2015), "Designing more sustainable and greener self-compacting concrete". *Construction and Building Materials*, 84, pp. 301-306, <https://doi.org/10.1016/j.conbuildmat.2015.02.072>.
- Mueller, H. S., Haist, M., Moffatt, J. S. & Vogel, M. (2017), "Design, Material Properties and Structural Performance of Sustainable Concrete". *Procedia Engineering*, 171, pp. 22-32, <https://doi.org/10.1016/j.proeng.2017.01.306>.
- Neville, A. M. (2009), "Properties of concrete", book, Harlow, England; New York, Prentice Hall/Pearson Education.
- Okamura, H., And Ozawa, K. (1995), "Mix design for self-compacting concrete", *Concrete Library of JSCE*, 25, pp. 107-120.
- Okamura, H. & Ouchi, M. (2003), "Self-Compacting Concrete. Journal of Advanced Concrete Technology", 1(1), pp. 5-15, <https://doi.org/10.3151/jact.1.5>.
- Persson, B. (2001), "A comparison between mechanical properties of self-compacting concrete and the corresponding properties of normal concrete", *Cement and Concrete Research*, 31(2), pp. 193-198, [https://doi.org/10.1016/S0008-8846\(00\)00497-X](https://doi.org/10.1016/S0008-8846(00)00497-X).
- Safuiddin, M. (2008), "Development of Self-Consolidating High Performance Concrete Incorporating Rice Husk Ash", PhD thesis, University of Waterloo.
- Suhendro, B. (2014), "Toward Green Concrete for Better Sustainable Environment. *Procedia Engineering*", 95, pp. 305-320, <https://doi.org/10.1016/j.proeng.2014.12.190>.
- Tasi, C., Li, L. & Hwang, C. (2006), "The Effect of Aggregate Gradation on Engineering Properties of High Performance Concrete", *Journal of ASTM International*, 3(3), pp. 1-12, <https://doi.org/10.1520/JAI13410>.
- Taylor, M. R., Lydon, F. D. & Barr, B. I. G. (1996), "Mix proportions for high strength concrete. *Construction and Building Materials*", 10(6), pp. 445-450, [https://doi.org/10.1016/0950-0618\(96\)00012-8](https://doi.org/10.1016/0950-0618(96)00012-8).
- Xie, Y., Liu, B., Yin, J. & Zhou, S. (2002), "Optimum mix parameters of high-strength self-compacting concrete with ultrapulverized fly ash", *Cement and Concrete Research*, 32(3), 477-480, [https://doi.org/10.1016/S0008-8846\(01\)00708-6](https://doi.org/10.1016/S0008-8846(01)00708-6).
- Yen, T., Tang, C.-W., Chang, C.-S. & Chen, K.-H. (1999), "Flow behaviour of high strength high-performance concrete", *Cement and Concrete Composites*, 21(5), 413-424, [https://doi.org/10.1016/S0958-9465\(99\)00026-8](https://doi.org/10.1016/S0958-9465(99)00026-8).

**Mohammed Abed** (1991) civil engineer (MSc). PhD researcher at the Department of Construction Materials and Technologies, Budapest University of Technology and Economics. Main fields of interests: Green, High-performance, Self-compacting and Recycled concrete. Waste materials, Recycled aggregate and Supplementary cementations materials. Non-destructive testing of concrete, Durability measurements, Fire resistance and Sustainable environment. Email: [abed.mohammed@epito.bme.hu](mailto:abed.mohammed@epito.bme.hu). Member of the Hungarian Group of fib and Member of Young Member Group of fib (YMG).

# EXPERIMENTAL STUDY ON THE BEHAVIOUR OF BONDED ANCHORING SYSTEMS IN FIBRE REINFORCEMENT CONCRETE



Viktor Hlavička - Éva Lubláy

DOI: 10.32970/CS.2018.1.5

*Our research mainly focuses on the behaviour of post-installed anchors in fibre reinforced concrete (FRC). In our tests three types of fibres (two types of steel and one type of polypropylene) were used as fibre reinforcement together with two different bonded anchoring systems (vinyl-ester hybrid, epoxy resin). Based on our test results we can state that application of shorter steel fibres has better effect on the resistance of bonded anchors compared to application of longer steel or polymer fibres.*

**Keywords:** fibre reinforcement concrete, fastening systems, bonded anchor, pull-out test, concrete cone failure, pull-out failure

## 1. INTRODUCTION

### 1.1 Fibre reinforced concrete (FRC)

Behaviour and properties of concrete can be amended by addition of fibres with different sizes and materials. At first, addition of steel fibres became general that improves the properties of hardened concrete mainly. It is widely applied for industrial floors because fibres improve the resistance against dynamic effects of vehicles and machines. Steel fibres can also be applied in reinforced concrete structures to reduce the amount or fully replace shear reinforcement. They can be effectively used in bent and tensioned structures because of their advantageous crack-bridging properties (*Fig. 1*) (Falkner, 1998). Based on previous studies, higher steel fibre content can also increase the compressive strength of concrete and the displacement. *Fig. 2* shows that energy dissipation (area below the stress-strain curve) increases as fibre content increases.

### 1.2 Anchorage in concrete

Several post-installed anchors are available with different methods of load-transfer. The commercially available

fastenings can transfer the load to the host material via the following mechanisms: mechanical interlock, friction or bond. Furthermore, the most recent techniques use combined bond and friction (e.g. bonded expansion anchors). In case of expansion anchors, the load is transferred by friction. Generally, an expansion sleeve is expanded by an exact displacement or torque applied on the anchor head during the installation process. Chemical fastenings are anchored by bond. Bonded anchors can be divided into two subgroups: capsule or injection systems. The bond material can be either organic, inorganic or a mixture of them. In this case the loads are transferred from the steel (normally a threaded rod, rebar) into the bonding material and are anchored by bond between the bonding material and the sides of the drilled holes. The load bearing capacity of bonded anchors with the same embedment depth depends on the type of the resin. (Eligehausen, Hofacker, Lettow, 2001; Eligehausen, Malée, Silva, 2006; Eligehausen, Cook, Appl, 2006).

Load bearing of fastenings can be determined by taking the minimum of ultimate loads corresponding to different failure modes. In case of tensioned anchors steel failure, concrete cone failure, pull-out failure and splitting can occur (*Fig. 3*) (Eligehausen, Malée, Silva, 2006).

**Fig. 1:** Crack propagation in fibre reinforced concrete (Li, Majer, 1996)

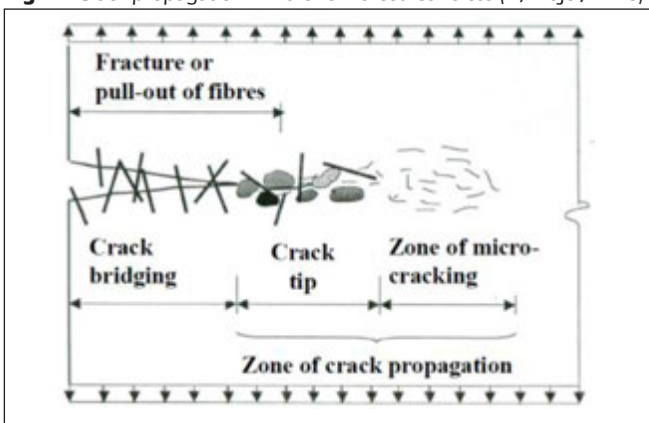

**Fig. 2:** Compressive strength of steel fibre reinforced concretes with different fibre content (Balázs, Erdélyi, 1996)

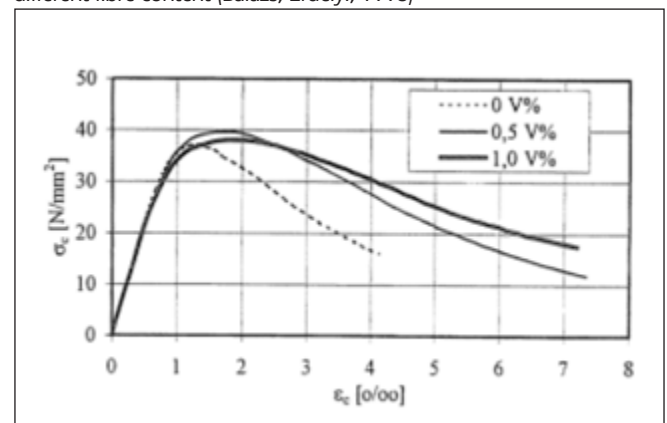

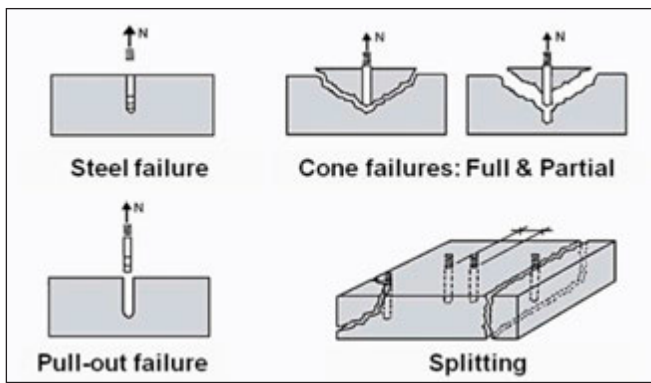

Fig. 3: Failure modes of anchors

Steel failure depends on the tensile strength of the steel rod. Steel capacity can be calculated from the ultimate steel strength and the cross-sectional area.

Splitting failure is caused by reaching the critical edge-spacing distances. Load bearing capacity can be influenced by distances from edges and by spacing distances; these effects can be taken into account by reduction factors.

Pull-out failure has to be discussed separately for bonded and expansion anchors. Pull-out failure of mortar bonded anchors means bond failure between mortar and concrete, while pull-out failure excluding mortar means bond failure between the steel fastening and the bonding material. The bond strength depends on the certain product, but its value is included in the corresponding approvals.

$$N_u = \pi \cdot d \cdot h_{eff} \cdot \tau_u \quad (1)$$

where:

$d$  = anchor bolt diameter [mm]

$\tau_u$  = bond strength [MPa]

Concrete cone failure can be calculated by the C-C Method (Concrete Capacity Method) (Fuchs, Eligehausen, 1995; Eligehausen, Ozbolt, 1999). The method is based on laboratory tests and numerical calculation:

$$N_u = k \cdot \sqrt{f_c} \cdot h_{ef}^2 \cdot \frac{1}{h_{ef}^{0.5}} = k \cdot \sqrt{f_c} \cdot h_{ef}^{1.5} \quad (2)$$

where:

$k$  = factor that depends on the type of the anchor

$h_{ef}$  = embedment depth [mm]

$f_c$  = concrete compressive strength [N/mm<sup>2</sup>]; ( $\sqrt{f_c} \approx f_{ct}$ )

$f_{ct}$  = concrete tensile strength [N/mm<sup>2</sup>]

In Eq. (1),  $h_{ef}^2$  corresponds to the failure surface and  $1/h_{ef}^{0.5}$  takes into account the size effect (Bažant, 1984). New result of this method is that it assumes a cone angle of 35° compared to former methods that used 45° (ACI Committee 349, 1985). Nowadays several design guides and standards suggest this method (CEB, 1994; fib MC2010, 2013; fib BULLETIN 58, 2011; prEN 1992-4, 2015; ETAG 001, 2013).

Different papers preceded the final form of the C-C Method. One of these used the bases of fracture mechanics to calculate the resistance against concrete cone failure (Eligehausen, Sawage, 1989):

$$N_u = k \cdot (E_c \cdot G_f)^{0.5} \cdot h_{ef}^{3/2} \quad (3)$$

where:

$k$  = factor that depends on the type of the anchor

$h_{ef}$  = embedment depth [mm]

$E_c$  = modulus of elasticity of concrete [N/mm<sup>2</sup>]

$G_f$  = fracture energy of concrete [N/mm]

There is no sharp change between cone failure and pull-out failure, the two failure modes combined, and partial cone failure occurs (Bajer, Barnat, 2012).

The calculation methods detailed above are only valid in case of normal concretes. Design guides and codes do not deal with the behaviour of anchors in fibre reinforced concretes. Meanwhile, based on Eqs. (2) and (3) it is visible that the resistance of anchors depends on the strength, Young's modulus and fracture energy of concrete, which parameters can be highly affected by the fibre type and fibre content applied. Therefore the formulae used in case of normal concretes may not be used in case of FRC, or only with modifications. Until now only few tests intended to examine and specify the behaviour of anchors installed in FRC.

Holschemacher et al (2002) tested expansion, undercut and bonded anchors with 60 mm embedment depth in FRC. In each case they applied steel fibres, but with two different geometries (elliptical, waved sheet cut steel fibres; round steel wire fibres with end hooks). The applied fibre content was 50 kg/m<sup>3</sup>. They experienced that the resistance values of the anchors in FRC were close to the resistance values in case of normal concretes, but the deviation of the measured values significantly increased. The reason for this could be the increased air content because of the fibres and the non-homogenous distribution of the fibres in the concrete. Non-homogenous distribution could lead to low number of effective fibres (fibres that perpendicularly crossed the cracks and therefore had significant crack-bridging effect).

Bokor et al (2017) tested bonded anchors individually and installed in a group in steel fibre reinforced concrete (SFRC). The applied embedment depth was 70 mm, the fibre content was 50 kg/m<sup>3</sup>. Their results showed 18 % increase in resistance in case of individual anchors, and 25-42 % increase in case of groups, depending on the loading (centric, eccentric). They showed that the effect of fibres was more significant in case of anchor groups, mainly because of ductile failure, during which, if one anchor reaches its ultimate limit state, it could still bear some load, and consequently it transmitted less load to the other anchors.

## 2. EXPERIMENTAL STUDY

### 2.1 Tested anchors

During our tests two different types of bonded anchors were used, one type with epoxy resin, and one type with vinyl-ester hybrid bonding material.

Proper mixing of high performance epoxy resin glues is ensured by special mixing rods. The bond is stress-free; therefore it can be applied in case of small edge distances and spacing. Consistency of the epoxy resin is higher than that of other glues therefore it can enter to the pores and can reach an adequate depth before hardening, resulting in higher amount of load transmission by adhesion. Average bond strength of the glue ( $\tau_u$ ) is 21.1 N/mm<sup>2</sup> (determined on the basis of confined tension test results in non-cracked normal concrete).

Vinyl-ester hybrid is a combined glue, that includes organic (vinyl-ester) and inorganic (cement) compounds. The glue is universal, it can be used for all kinds of building materials and loading types. The bond is stress-free; therefore

it can be applied in case of small edge distances and spacing. The consistency of it is more granular than that of the epoxy resin and this property also remains after hardening. Its characteristic bond strength ( $\tau_u$ ) is 15.0 N/mm<sup>2</sup> (determined on the basis of confined tension test results in non-cracked normal concrete).

During our tests with bonded anchors, size M8 and grade 10.9 threaded rods were applied. The high tensile strength of the rod prevented steel failure therefore cone failure of concrete could be examined.

Applied embedment depth was 50 mm in each case.

## 2.2 Concrete mixtures

During our tests two types of steel and one type of polypropylene fibres were used. Properties of the chosen fibres are included in Table 1.

Beside FRC specimens, normal concrete specimens were also manufactured. The initial composition was always the same, in case of FRCs, the consistency class (T4) that belonged to normal concretes was set by addition of plasticizer. In case of fibre S1, four different fibre contents (20, 30, 40, 80 kg/m<sup>3</sup>), in case of fibre S2 two different fibre contents (40, 80 kg/m<sup>3</sup>), while in case of fibre P three different contents (3.0, 4.5, 6.0 kg/m<sup>3</sup>) were used. Composition of concrete mixtures is summarized in Table 2.

The specimens were held under water for 7 days and then kept at laboratory temperature (20 °C) for additional 21 days. The dimensions of concrete specimens for pull-out tests were 300×300×150 mm. This geometry corresponds to the prescribed parameters of the ETAG 001 (2013). In case of this geometry the probability of splitting is very low. For each mixtures compressive strength was tested on 3 cubes with 150×150×150 mm dimensions, flexural tensile strength was measured on 3 prisms with 70×70×250 mm dimensions (that were cut out from the 300×300×150 mm specimens to prevent the effect of fibre orientation), while splitting-tensile strength was measured on 4 cylinders with height and diameter 150 mm.

## 2.3 Pull-out test

Our unconfined test setup is shown in Fig. 4. The loading device was a displacement controlled test apparatus, which allowed the recording of residual stress after the failure. This setup enabled the formation of all possible failure modes, the

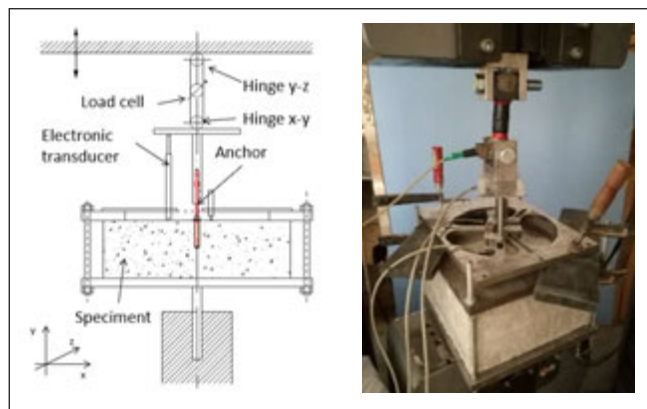

Fig. 4: Arrangement of pull-out test

results were not affected by the geometry of the investigated samples (thickness of the test member, critical edge, placing). The measurement setup was capable to measure, record and show the applied load and related displacement of the anchor in real-time. The perpendicular pin-joints ensured the centrality of the acting force. Two electronic transducers measured the displacement, while three additional independent displacement transducers were used to record the deformation of the surface. The load was measured by a calibrated load cell. The tests were carried out in accordance with the instructions given in ETAG 001 (2013). The support distance was greater than  $4 h_{ef}$ .

## 3. RESULTS AND DISCUSSION

### 3.1 Concrete strengths

Compressive strength of concrete was tested 28 days after mixing. The test results are presented in Fig. 5.

From the compressive strength test results we can see that due to the addition of fibre S1 between 20 and 40 kg/m<sup>3</sup> content the strength slightly increases, while in case of 80 kg/m<sup>3</sup> it decreases. Decrease of strength due to higher fibre content can be explained by the extra air content that was added during addition of fibres. In case of mixtures with fibres S2 and P slight decrease of strength can also be seen, which also can be explained by the increased air content. The different level of this decrease can be explained by the different geometry of the fibres.

Table 1: Properties of fibres

Name	Material	Legths [mm]	Diameter [mm]	Tensile strength [N/mm <sup>2</sup> ]	Surface
S1	steel	50	1,0	1000-1200	smooth and hooked end
S2	steel	12	0,2	3000	smooth
P	polypropylen	50	0,5	618	roughened along the length

Table 2: Concrete mixtures

Name	Cement CEM I 42,5 N [kg/m <sup>3</sup> ]	Aggregate 0-4 mm [kg/m <sup>3</sup> ]	Aggregate 4-8 mm [kg/m <sup>3</sup> ]	Aggregate 8-16 mm [kg/m <sup>3</sup> ]	Water [kg/m <sup>3</sup> ]	Fibre content [kg/m <sup>3</sup> ]	w/c [-]
N	290	833	463	556	196	0	0,675
S1						20, 30, 40, 80	
S2						40, 80	
P						3.0, 4.5, 6.0	



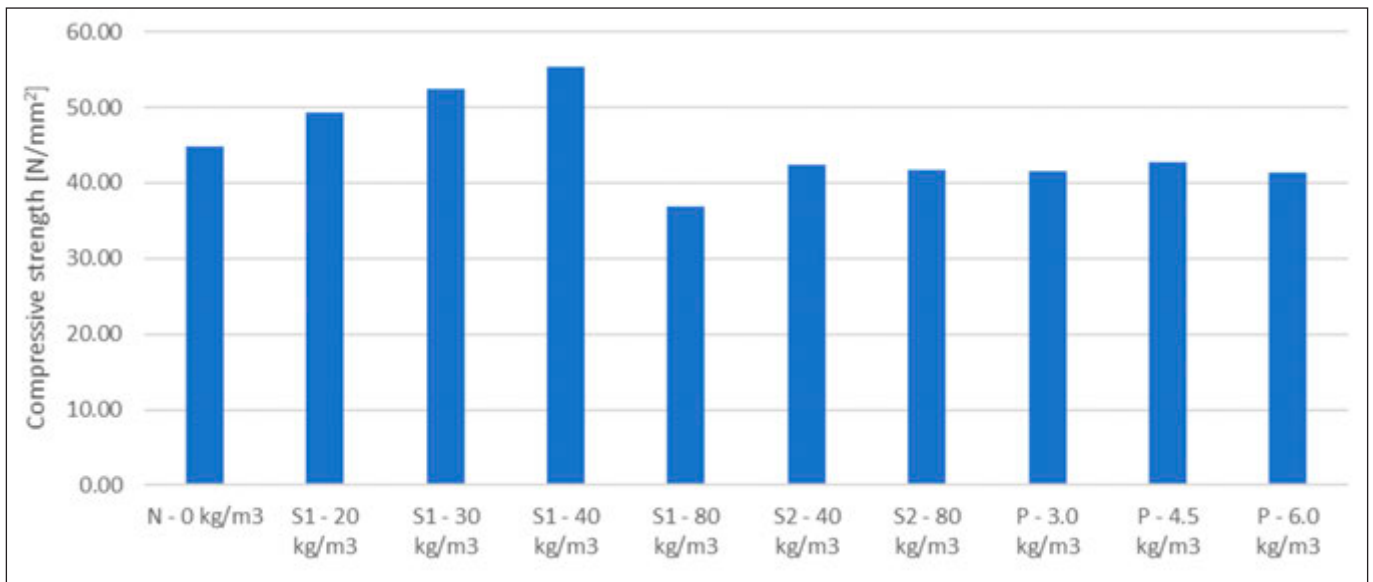

Fig. 5: Results of the concrete compressive strength test

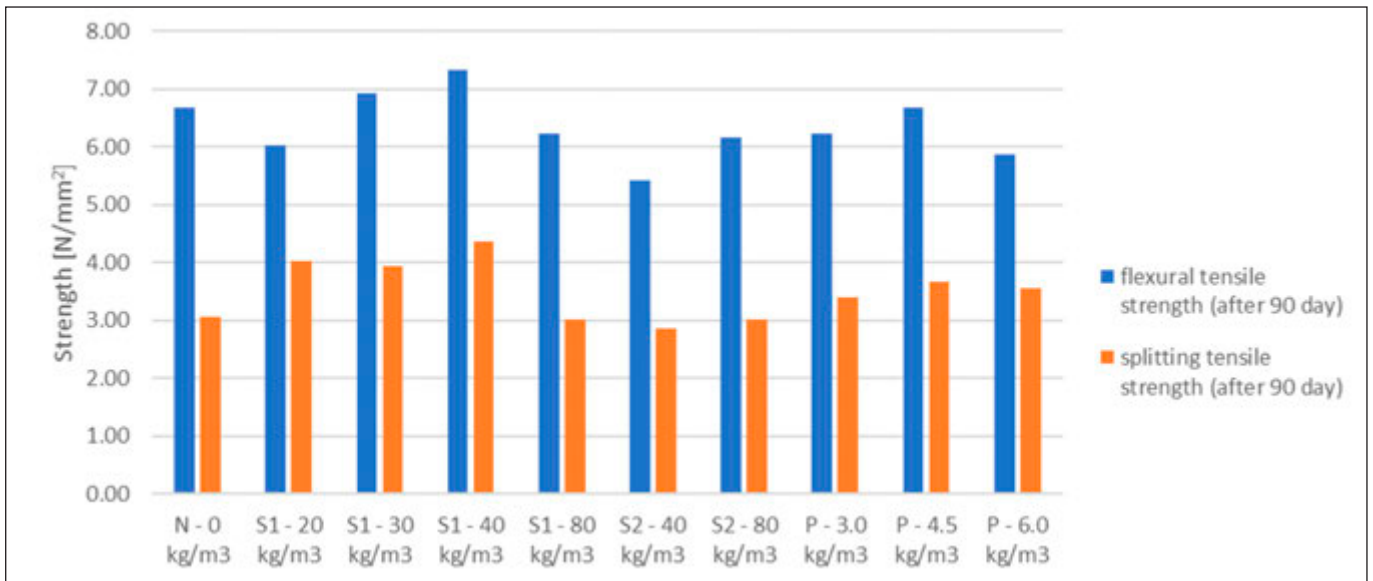

Fig. 6: Results of the concrete flexural tensile and splitting tensile strength tests

Flexural and splitting tensile strength of concrete were tested 90 days after mixing, because the specimens were cut out from the 300×300×150 mm specimens (to avoid uneven fibre-orientation) that were at first used during the pull-out tests. Flexural and splitting tensile strength values of the different mixtures are summarized in Fig. 6.

### 3.2 Results of the pull-out tests

Results of the pull-out test are detailed in Table 3. The results show that in case of both types of glues, in case of fibre S1 with 20-30 kg/m<sup>3</sup> content, resistance and failure mode are the same as for concrete without fibres. In case of 40 kg/m<sup>3</sup> fibre content the resistance increases, but failure mode does not change, while in case of 80 kg/m<sup>3</sup> the resistance increases and in case of epoxy resin, the failure mode changes to the combination of cone failure and pull-out of the glue. (Fig. 7).

In case of steel fibre S2, 40 kg/m<sup>3</sup> content already results in significantly higher resistance in case of both types of glues, failure mode changes to the combination of concrete cone and pull-out failure in case of epoxy resin, while in case of vinyl ester to pull-out failure. Pull-out of the anchor is the consequence of the cease of the bond between the glue and

the concrete, which also means that the fixing system reached its ultimate state. In case of 80 kg/m<sup>3</sup> the resistance further increases, and pull-out occurs in case of both epoxy resin and vinyl ester (Fig. 8).

In case of polypropylene fibre P, in case of epoxy resin the resistance and the failure mode do not change between 3-6 kg/m<sup>3</sup> fibre content. In case of vinyl-ester the resistance slightly decreases, while the failure mode does not change (Fig. 9).

## 4. CONCLUSIONS

Our research mainly focuses on behaviour of post-installed anchors in fibre reinforced concrete (FRC). In our tests three types of fibres were used as fibre reinforcement together with two different bonded anchoring systems (vinyl-ester hybrid, epoxy resin).

During the tests two types of steel fibres with different geometry and one type of polymer fibre were used. Steel fibres were different in dimension and length: fibre type S1 had length 50 mm, diameter 1 mm, had smooth surface and hooked end; while fibre type S2 had length 12 mm, diameter 0.2 mm, with smooth surface. Length of polymer fibre P was the same as length of the longer steel fibre (50 mm), its diameter was 0.5 mm and its surface was roughened.

**Table 3:** Mean tensile resistances and typical failure modes of pull-out tests

Name	Epoxy resin		Vinyl-ester resin	
	Mean tensile resistance [kN]	Typical failure mode	Mean tensile resistance [kN]	Typical failure mode
N	24.78	concrete cone	22.84	partial concrete cone
S1 - 20 kg/m <sup>3</sup>	25.67	concrete cone	23.27	partial concrete cone
S1 - 30 kg/m <sup>3</sup>	24.54	concrete cone	20.96	partial concrete cone
S1 - 40 kg/m <sup>3</sup>	28.31	concrete cone	-	-
S1 - 80 kg/m <sup>3</sup>	29.85	partial concrete cone	24.85	partial concrete cone
S2 - 40 kg/m <sup>3</sup>	32.68	partial concrete cone	26.38	pull-out
S2 - 80 kg/m <sup>3</sup>	36.04	pull-out	28.14	pull-out
P - 3.0 kg/m <sup>3</sup>	23.52	concrete cone	17.52	partial concrete cone
P - 4.5 kg/m <sup>3</sup>	23.69	concrete cone	19.11	partial concrete cone
P - 6.0 kg/m <sup>3</sup>	24.01	concrete cone	17.76	partial concrete cone

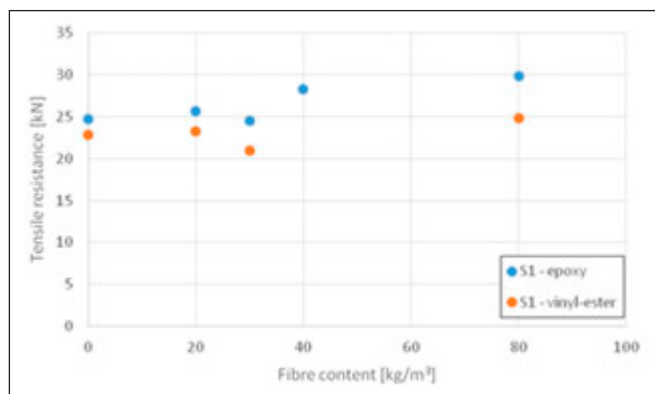

**Fig. 7:** Effect of type S1 fibre content on the tensile resistance of anchors (each point is the mean value of 3 results)

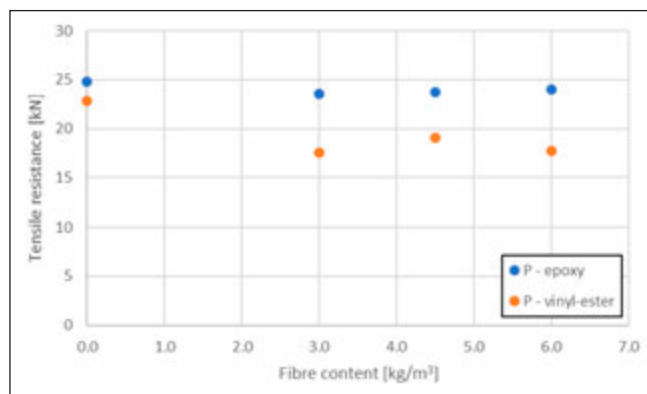

**Fig. 9:** Effect of type P fibre content on the tensile resistance of anchors (each point is the mean value of 3 results)

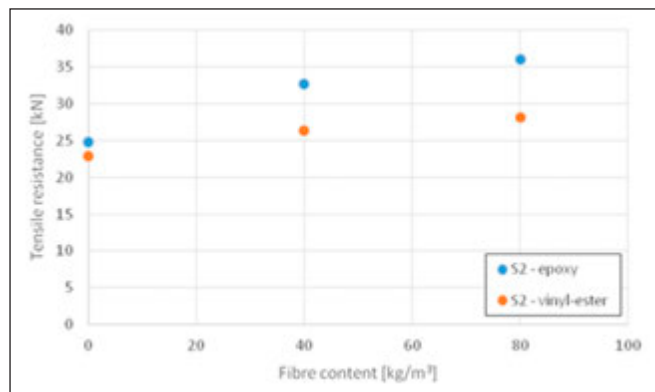

**Fig. 8:** Effect of type S2 fibre content on the tensile resistance of anchors (each point is the mean value of 3 results)

In addition to fibre reinforced concrete specimens, normal concrete specimens were also cast and tested. Initial concrete composition was the same at each case. In case of fibre S1, four different fibre contents (20, 30, 40, 80 kg/m<sup>3</sup>), in case of fibre S2 two different fibre contents (40, 80 kg/m<sup>3</sup>), while in case of fibre P three different contents (3.0, 4.5, 6.0 kg/m<sup>3</sup>) were used.

Based on the results of the pull-out tests the following can be drawn:

- In case of the addition of the longer steel fibres (type S1): 20-30 kg/m<sup>3</sup> fibre content did not have an effect on the resistance of the bonded anchors, 40 kg/m<sup>3</sup> fibre content slightly, while at 80 kg/m<sup>3</sup> significantly increased the resistance.

- In case of the shorter steel fibres the resistance increased significantly already in case of 40 kg/m<sup>3</sup> fibre content, while in case of 80 kg/m<sup>3</sup> fibre content the failure mode changed to pull-out failure which means the ultimate capacity of the bonded anchor system.
- In case of polymer fibre P, if epoxy resin was applied then the resistance did not change between 3-6 kg/m<sup>3</sup> fibre content. In case of vinyl-ester the resistance slightly decreased, while failure mode remained the same.

Based on our test results we can state that application of shorter steel fibres has better effect on the resistance of bonded anchors compared to application of longer steel or polymer fibres. The reason for this is the higher number of fibres if same content is applied, higher number of fibres results in more effective fibres that bridges the cracks of the concrete cone.

## 5. ACKNOWLEDGEMENT

The authors wish to thank Szabolcs Kovács-Sebestény (Fischer Hungary LPs.) for providing the necessary anchors and dr. Salem Georges Nehme (Department of Construction Materials and Technology, BME) for designing the concrete mixtures.

SUPPORTED BY THE ÚNKP-18-3 NEW NATIONAL EXCELLENCE PROGRAM OF THE MINISTRY OF HUMAN CAPACITIES

## 6. REFERENCES

- ACI Committee 349 (1985): "Code Requirements for Nuclear Safety Related Concrete Structures (ACI 349-85)", *American Concrete Institute*, Detroit
- Bajer, M., Barnat, J. (2012): "The glue-concrete interface of bonded anchors", *Construction and Building Materials journal*, 34, pp. 267-274. <https://doi.org/10.1016/j.conbuildmat.2012.02.030>
- Balázs Gy. L., Erdélyi L. (1996). „A beton szivósságának növelése acélszálakkal”, *Budapesti Műszaki és Gazdaságtudományi Egyetem*
- Bazant, Z. P. (1984): "Size Effect in Blunt Fracture: Concrete, Rock, Metal", *Journal of Engineering Mechanics*, ASCE, 110, No. 4, April, pp. 518-535. [https://doi.org/10.1061/\(ASCE\)0733-9399\(1984\)110:4\(518\)](https://doi.org/10.1061/(ASCE)0733-9399(1984)110:4(518))
- Bokor, B., Tóth, M., Sharma, A. (2017): "Influence of steel fibre content on the load-bearing capacity of anchorages in concrete", *3rd International Symposium on Connections between Steel and Concrete* (Editors: Sharman, A., Hofmann, J.), Stuttgart, Germany, 27-29 September, pp. 1258-1269. ISBN 978-3-945773-06-2
- Comité Euro-International du Béton (CEB) (1994): "Fastenings to Concrete and Masonry Structures: State-of-the-art report". *Bulletin D'Information No. 216*, Lausanne, published by Thomas Telford Services Ltd, London
- Eligehausen R., Cook, A. R., Appl, J. (2006): "Behavior and Design of Adhesive Bonded Anchors", *ACI Structural Journal*, November-December, pp. 822-831.
- Eligehausen R., Hofacker I., Lettow S. (2001): "Fastening technique – current status and future trends", *International Symposium on Connections between Steel and Concrete*, Volume One, Stuttgart, Germany, pp. 11-27.
- Eligehausen R., Malleé R., Silva J. F. (2006): "Anchorage in Concrete Construction", *Ernst&Sohn*, ISBN: 978-3-433-01143-0
- Eligehausen, R., Ožbolt, J. (1999): "Size Effect in Design of Fastenings, Mechanics of Quasi-Brittle Materials and Structures" (Edited by: Pijaudier-Cabot, G., Bittnar, Z., Gérard, B.), *HERMES Science Publications*, Paris, pp. 95-118. ISBN 2-86601-729-3
- Eligehausen, R., Sawage, G. (1989): "A fracture mechanics based description of the pull-out behaviour of headed studs embedded in concrete", *Fracture Mechanics of Concrete Structures, From Theory to Applications* (Editors: Elfgren, L.), Chapman and Hall, London, New York, pp. 281-299. DOI: 10.18419/opus-7930
- ETAG 001 (2013): "Guideline for european technical approval of metal anchors for use in concrete", *EOTA*, Avenue des Arts 40 Kunsiaan, B – 1040 Brussels
- Falkner, H. (1998). „Innovatives Bauen”, *Betonwerk-Fertigteil-Technik* 4/1998: 42-51
- fib BULLETIN 58 (2011): "Design of anchorages in concrete", ISBN: 978-2-88394-098-7
- fib MODEL CODE 2010 for Concrete Structures (2013): "Concrete to steel" pp. 183-189. ISBN: 978-3-433-03061-5
- Fuchs, W., Eligehausen, R., Breen, E. J. (1995): "Concrete Capacity Design (CCD) Approach for Fastening to Concrete", *ACI Structural Journal*, January-February, pp. 73-94.
- Holschemacher, K., Klug, Y., Wittmann, F. (2002): "Experimental Investigations on Fastenings in Steel Fibre Reinforced Concrete", *LACER*, No. 7, pp. 145-158.
- Li, V., Maalej, M. (1996). "Toughening in Cement Based Composites, Part I: Cement, Mortar and Concrete", *Cement and Concrete Composites*, 18/4, pp. 223-237. [https://doi.org/10.1016/0958-9465\(95\)00028-3](https://doi.org/10.1016/0958-9465(95)00028-3)
- prEN 1992-4 Eurocode 2 Design of concrete structures - Part 4 Design of fastenings for use in concrete, European committee for standardization, CEN/TC 250, Brussels, FprPREN 1992-4:2015
- Viktor Hlavička** (1987) structural engineer (MSc), PhD candidate of the Department of Construction Materials and Technology at the Budapest University of Technology and Economics. His main fields of interest are: fastening to concrete, fastening systems, finite element modelling. Member of the Hungarian Group of *fib*.
- Éva Lublóy** (1976), PhD, Senior lecturer in structural engineering at the Budapest University of Technology and Economics. Her main fields of interest are: fire design, behaviour of constructions materials at elevated temperature. Member of the ungarian Group of *fib*.

# REPORT ABOUT THE SUCCESSFUL CCC2017 CONGRESS, 31 AUG. – 1 SEPT. 2017 TOKAJ, HUNGARY

DOI: 10.32970/CS.2018.1.6

Intention of CCC Congresses (Central European Congress on Concrete Engineering) in general is to provide a regular forum for meeting and technical discussions of experts in the field of concrete engineering. Practicing engineers – both from design and construction – as well as researchers are meeting regularly. The series of CCC Congresses were founded by Austria, Croatia, Czech Republic, Hungary in 2004. Poland joined some years later.

This event attracts engineers from design, material production, prefabrication, quality control and research.

CCC2017 had 186 registered participants from 17 countries (Austria, Belgium, Bosnia Herzegovina, Brasilia, Czech Republic, China, Croatia, Hungary, Poland, Republic of South Africa, Switzerland, Serbia, Slovak Republic, Slovenia, USA) from 4 continents (Europa, Asia, Africa és America).

Interest from so many counties indicates that there is an interest towards the performance of Central-European countries in the world.

The Congress has been organized at the Conference and Cultural Centre of Tokaj, Hungary 31 August – 1 September 2017 that provided an excellent possibility for all the particular events of the Congress including: Oral Sessions, Poster Sessions as well as the Exhibition

Main organizer of CCC2017 Congress was the Hungarian Group of fib (International Federation for Structural Concrete). Co-organizers were: Faculty of Civil Engineering of Budapest University of Technology and Economics, Assocaiaions CemMBeton and MABESZ.

The CCC2017 Congress Proceedings (including 83 written contributions) can be directly downloadable form the following homepages [www.fib.bme.hu/ccc2017.html](http://www.fib.bme.hu/ccc2017.html)

The title of CCC2017 expresses the intention to advanced materials and advanced solutions in the field of concrete engineering:

## Innovative materials and technologies for concrete srtructures.

### Topic 1

#### **TAILORED PROPERTIES OF CONCRETE**

Environmentally compatible cements. New types of Aggregates. High performance admixtures. High strength and high performance concretes. Fibre reinforced concrete. Lightweight concrete. Green concrete. Applications.

### Topic 2

#### **ADVANCED REINFORCING AND PRESTRESSING MATERIALS AND TECHNOLOGIES**

Metallic and non-metallic reinforcements. Internal and external reinforcements. Applications.

### Topic 3

#### **ADVANCED PRODUCTION AND CONSTRUCTION TECHNOLOGIES**

Concrete structures meeting high requirements. Prefabrication. Design aspects. Applications.

### Topic 4

#### **ADVANCED CONCRETE STRUCTURES**

Recent successful application of concrete for bridges, buildings and other structures.

### Topic 5

#### **MODELLING, DESIGN AND CODIFICATION**

In the following you find the specific list of subjects addressed by the contributions for CCC2017 indicating a wide range of subjects of concrete engineering in alphabetic order:

**Fig 1:** CCC2017, Tokaj, Opening ceremony (31 Aug, 2017)



**Fig 2:** CCC2017, Tokaj, Opening - the audience (31 Aug, 2017)





**Fig 3:** CCC2017, Tokaj, The organizing countries (31 Aug, 2017)



**Fig 7:** Presentation by Andor Windisch



**Fig 4:** Presentation by Jan Vitek (Praha)



**Fig 5:** Presentation by Jelena Bleiziffer (Zagreb)



**Fig 6:** Presentation by Mark Salamak (Gliwice)

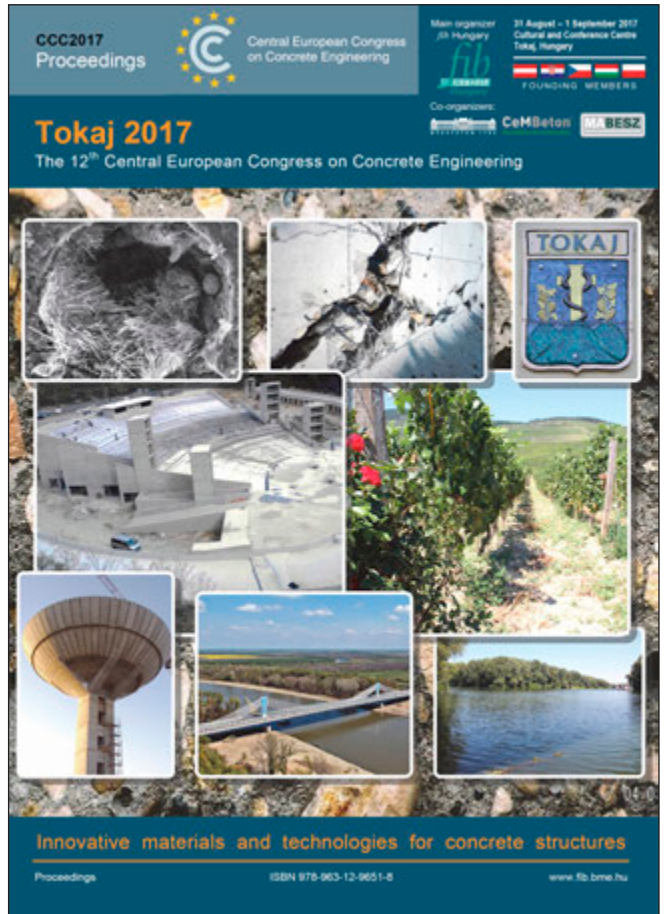

**Fig 8:** CCC2017 Proceedings – <http://www.fib.bme.hu/konyvek/ccc2017.pdf>

Additives (1), BIM (1), Bond (3), Bridges (14), Carbon nano tubes (1), Cements with low alkali content to bridges (1), Creep (1), Compressive strength (1), Corbel (1), Cracking (2), Deformations (2), Digital image correlation (2), Durability (3), Early age concrete (1), Fastenings (2), *fib* MC2010/EC2 (6), Foundations Fire resistance (3), (1), Fracture mechanics (1), Frames (1), Fresh and hardened concrete properties (1), FRC (10), FRP (4)UHPC/HSC (8), High rise buildings (1), Integrated sensors (1), Joints (1), Life cycle analysis (1), Modulus of elasticity of concrete (2), Monitoring (2), Numerical simulations (4), Precast concrete (5), Prestressed concrete (5), Probabilistic studies (1), Recycling (4), Rheological aspects (2), Shear (4), Shells (1), Sprayed concrete (1), Steel-concrete composite (1), Strengthening (5), Supplementary cementitious materials (1), Thaumassite (1), Tunnel lining (1), Visual programming (1), Water tightness (1) and 100y old concretes.

I take this opportunity to express our thanks for the sponsors of CCC2017: *A-Híd Co.* (main sponsor), *Duna Drava Cement Ltd. from Heidelberg Group*, *Sika Hungary Ltd.*, *Mapei*, *Hydrastat Ltd.* and *Sauska Winery*.

We express our thanks also to the exhibitors of CCC2017: *Cervenka Consulting*, *Swietelsky Hungary Ltd.*, *Meselia-*

*NewChem and Aigner Albrecht Anlagenbau*. CCC2019 Congress will be organized next time in September 2019 in Croatia. You are kindly invited to join.

*György L. Balázs*  
*Chairman of Scientific Committee for CCC2017 Tokaj*



ÉMI-TÜV

Add value.  
Inspire trust.

## ÉMI-TÜV SÜD

Solutions that ensure quality,  
safety and sustainability for future  
generations

**ÉMI-TÜV SÜD is a premium quality, safety and technical service provider that specialises in testing, inspection, auditing, certification, training, and knowledge services.**

### Service fields:

- Lifts, escalators and moving walks
- Cranes and machinery
- Pressure equipment (boilers, pressure vessels, industrial hose pipes)
- Industrial equipment's and welding technology
- Civil and structural engineering services
- Full-scale testing of structures, elevators and construction products
- Leisure Parks, Developments & Ride
- Children's Playgrounds & Equipment

- Consumer products (Textiles; Toys and child care products; Cosmetics, Food and food contact materials; Household products and household chemicals; Paints, varnishes and coatings; Furniture and wood products; Cementitious adhesives; Boilers and fireplaces
- Audit and Management system certification

### Our services for the construction industry:

- Technical inspection of existing plants, buildings
- Building Diagnostics
- Assessment of existing structures
- Design of structural strengthening
- Testing of load-bearing elements
- Dynamic on-field and laboratory tests
- Compliance checks in accordance with EN standards
- Factory Production Control

CREATING THE **FUTURE**



**A-HÍD**

A-HÍD ZRt.  
H-1 138 BUDAPEST  
KARIKÁS FRIGYES U. 20.

[www.ahid.hu](http://www.ahid.hu)

